



www.LASITACABINS.COM

GARDEN
BUILDINGS
& CABINS

2017
COLLECTION





INTRODUCING LASITA MAJA

We are pleased to present our 2017 collection. For nearly 20 years now, we have had the pleasure of offering you a selection of garden buildings and cabins for your holidays.

Over all these years, we have continued to commit ourselves to coming up with new projects for developing and improving our range of cabins. We constantly pay attention to changing market needs and expectations, so that we can bring you an increasing choice of cabins to suit your specifications, and to fit the special purpose you need them for. Each request is unique and requires its own original solution.

Lasita Maja is seeking to develop cabins that suit your outside world and life. You can use your new space for taking it easy while the kids play, or simply as an extra living area added onto your home.

To satisfy you, the customer, we decided to set up a total quality process including production, delivery and customer service. Genuine communication and interpersonal relations are vital from the moment we meet, to the delivery of your LASITA MAJA cabin.

Discover the brand new world we are offering you right now, we have broken new ground this year by developing three lines, contemporary, classic and basic, to keep even closer in touch with your needs.





AS Lasita Maja is an Estonian based company with a main manufacturing site in Tartu. We have been manufacturing log cabins since 1998 and have been steadily growing ever since. This allowed us to establish a new, state of the art 6,000m² manufacturing site in 2011. We have over 250 employees in 3 different factories and we produce over 35,000 quality buildings per year which totals for about 1200 full truckloads.



COMPANY PROFILE



Our door and window factory produces over 80,000 different doors and windows per year. The window factory is spread over 4,000m².

Three different factories enable us to make very different log cabin designs in 19 / 21 / 28 / 34 / 40 / 44, 70 or 94 mm wall thicknesses, varying from sheds, summerhouses, saunas, pavilions, garages and children playhouses up to special bespoke buildings for our best customers. There are over 400 different designs in our standard range plus countless numbers of bespoke projects, which illustrates our commitment to our customers.

We supply Internationally across Europe and Australia, USA, Japan, Russia, Turkey, UAE.

Customer satisfaction is our first priority, backed by our strict quality standards. On 27th November 2007, LRQA issued the quality management certificate ISO 9001. The FSC certificate is the proof of our environment friendly production policy, our eco-friendly timber management policy.

We supply only through our nominated UK agents. We do not supply direct to the end consumer, but we are happy to offer advice, and supply you with technical information.





Garden House with corner connection assembly, available in a wide choice of sizes from slow grown Nordic Spruce, 14mm to 98mm



Doors & Windows from our DGP + (double glazed premium, are with silicone gasket to improve insulation of your cabin



Our wall beam profile is made with a wind-tight connection, to ensure a warm cabin with no leaks

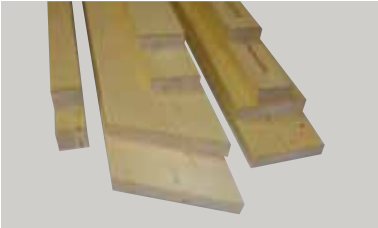

Fillets, beadings and mouldings included

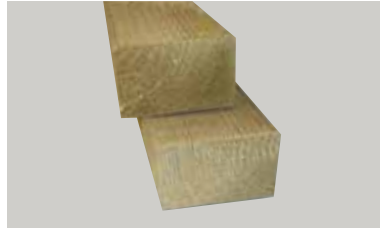

Impregnated bearers protects the building against humidity and extends its durability

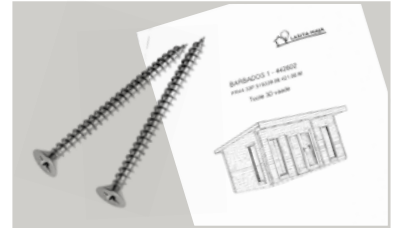

Fixings and assembly instructions come with every building

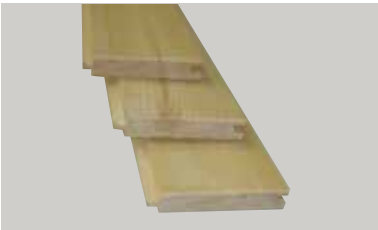

18mm roof & floor boards come as standard on UK models (for bespoke or larger cabins we offer 28mm boards)

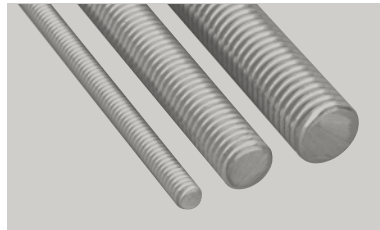

Wood storm protection or threaded rod depending on model, to protect house from strong winds



Our houses are packed carefully, on a real wooden pallet, with UV protection folio to preserve them of bad weather conditions and with strapping to ensure better stability during transport



Door Hinges on UK models are supplied now as DGP+ which are adjustable 5 ways



UK model cabins are supplied as standard with double glazed 3-6-3 real glass, silicone sealed

QUALITY CONTROL



External doors come with cylinder locks as standard with high quality finish

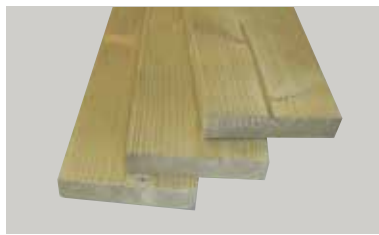

Terrace boards are impregnated



UK door openings come with aluminium low threshold



UK DGP+ windows are supplied with an Aluminium water gutter as standard to prevent water from entering



Windows with double closing system and tilt and turn opening system, except for horizontal fixed windows



Entry doors with low sill, to provide you easier acces to store your heavy garden tools and machines in your house



- ✓ *An experienced supplier*
- ✓ *Unparalleled quality*
- ✓ *FSC® - Certified scandinavian wood*
- ✓ *Sophisticated product design*
- ✓ *Sustainable partnership*
- ✓ *Meeting our commitments*
- ✓ *Genuine garden buildings manufacturer*
- ✓ *Flexibility of supply*



< All 70mm cabins
come with improved
window and door
hardware for
2017

All photos in this brochure are for illustrative purposes only. We reserve the right to change the featured cabin designs without prior notice. All dimensions shown are approximate.

COMPANY PROFILE

An experienced supplier

In 20 years, we have become one of the leading manufacturers in Europe. With over 95% of our output exported abroad, we aim to rank among the top 10 European players in the market.

A genuine garden buildings manufacturer

LASITA MAJA is an experienced, clearly structured business with 3 manufacturing plants organised according to specialisation. Our main plant manufactures standard buildings and cabins in large series. Our second production unit supplies us with most of our joinery needs. Finally, our third plant is specialised in, and dedicated to, the manufacture of standard holiday cabins in 58 mm, 70 mm or 92 mm profiles. We make over 20,000 cabins a year, by combining our total mastery of traditional manufacturing techniques with modern and efficient high-tech processes.

Unparalleled quality

To fully satisfy our customers, we have set up a quality management system that complies with ISO standard 9001. What's more, our cabins come with a 2- or 5-year warranty (subject to the terms of our general sales conditions).

FSC®-Certified, Scandinavian wood

Our cabins are manufactured using Nordic spruce wood. We have chosen this wood of Scandinavian origin for its natural hardness, long life span, structural resistance and aesthetic appearance, brought about by the very slow growth of the trees, due to the very long, harsh winters.

Respect for the environment is our priority, we have therefore made the responsible choice to use wood obtained from forests managed in accordance with FSC® rules (Forest Stewardship Council).



Sophisticated product design

Inspired by the outdoor spirit, our range of cabins offers user-friendly, functional advantages, in either a classic or contemporary style. What's more, the expert skills of our designers and technical draughtsmen make us an ideal partner for the development of your personalised projects.

Sustainable partnerships

Our privileged partnerships with our customers are based on the search for joint commercial benefits in the long term. In order to meet our customers' needs and respond to the developments in our market, our company constantly strives to improve and perfect its work.

Flexibility of supply

Our sales team is renowned for its availability and responsiveness. It is willing and able to help you find solutions and adapt to last-minute changes and special requests.

Meeting our commitments

We make every endeavour to stick to our commitments to our customers and supply you with the required product on time. We can make speedy deliveries thanks to our coverage of the main European countries. Yet another reason why we should work together.



New for 2017
**IMPROVED DOOR
AND WINDOW
QUALITY**



Our UK cabins boast upgraded door and window hardware



Key features of our Double Glazed Premium Plus windows and doors:

- Lasita & Nordic doors and windows are extremely solid and robust in construction, for 2017 we have upgraded the quality of our hardware.
- Produced from Pine for a better quality finish.
- Doors and windows on our bespoke/nordic range have high quality double glazed sealed units 22mm ($U \geq 2,8$) Glazing from the outside with wooden glazing bead. Fastened with nails, sealed with silicone.
- Windows are fitted aluminum water gutter.
- All doors are fitted with a European cylinder lock, aluminum cover plates.
- All windows and doors are fitted with rubber draught excluders.
- Doors and windows are manufactured from laminated wood. This helps to prevent warping, but we also treat with Remmers Induline for extra protection.
- Sprung Lock
- Handy adjustable split hinges including protection covers for the hinges
- Doors are fitted with aluminum wear strip to protect the threshold.
- Crossbars have a simple click in clip system. Very handy for painting and cleaning.
- Doors can be hinged on right hand side without an extra charge.





CONTENTS

CONTEMPORARY RANGE

14 - 49

CLASSIC RANGE

50 - 87

ACCESSORIES

88 - 95





▲ **BARBADOS 3 70**
PAGE 25



▲ **BARUDA 53**
PAGE 29



▲ **BORA UK**
PAGE 30



◀ **BRIGHTON 44**
PAGE 31



CONTEMPORARY



▲ JUBILEE 44
PAGE 40



ALEX

PAGE 20
4414440



300 x 250



ALEX 70

PAGE 21
7010940



250 x 300



ALEX MINI

PAGE 22
4416540



250 x 200



BARBADOS 2

PAGE 23
4414502



339 x 519



BARBADOS 3

PAGE 24
4414602



399 x 309



BARBADOS 3 70

PAGE 25
7011602



309 x 399



BARBADOS 3 TWIN

PAGE 26
443780



309 x 399



BARBADOS MINI

PAGE 27
4415040



240 x 330



BARBADOS MINI 70

PAGE 28
7010802



240 x 330



BARUDA 53

PAGE 29
407999



330 x 510



BORA UK

PAGE 30
4414902



450 x 300



BRIGHTON 44

PAGE 31
4416902



520 x 370

Our contemporary range boasts a selection of styles for all modern tastes



▲ **BRIGHTON 44**
PAGE 31



CARDIFF

PAGE 32
4421902



380 x 380



CARLISLE

PAGE 33
405602



350 x 300



DORSET 34

PAGE 34
348902



390 x 250



DORSET 71

PAGE 35
7095022



250 x 400



DORSET 72

PAGE 36
709602



250 x 450



DORSET 73

PAGE 37
709702



250 x 480



DUNDEE 44

PAGE 38
4419802



370 x 575



JAVA 44

PAGE 39
4415802



608 x 390



JUBILEE 44

PAGE 40
4411202



350 x 300



LYNDHURST

PAGE 41
7011902



400 x 550



MONTROSE

PAGE 42
4419902



370 x 575



ORKNEY I

PAGE 43
704102



390 x 520



ORKNEY 4

PAGE 44
704542



390 x 610



SHETLAND 2

PAGE 45
7011202



300 x 600



SHETLAND 2 TWIN

PAGE 46
4419780



300 x 600



STAFFORDSHIRE I

PAGE 47
7012402



370 x 540



STAFFORDSHIRE 2

PAGE 48
7012502



370 x 540



TORQUAY 44

PAGE 49
4417502



575 x 370

NEW FOR 2017:
The Cardiff



▲ **CARDIFF**
PAGE 32



ALEX

4414440

300 x 250

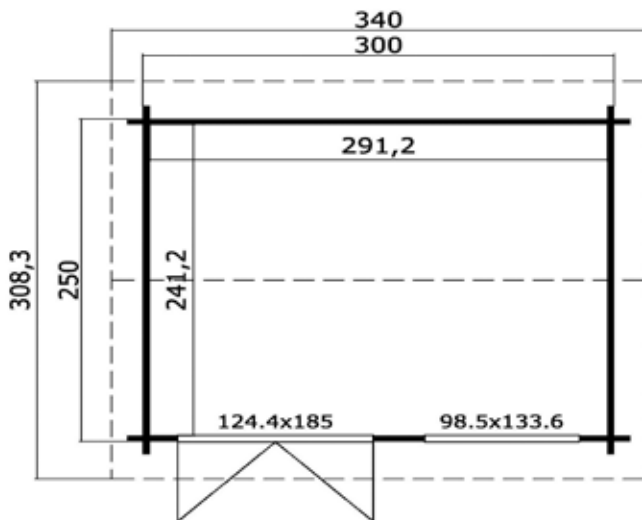

DIMENSIONS

Floor Area	7.50 m ²
Roof dimensions	3,40 x 3,08
Cubic volume	≈ 17,1 m ³
Wall height	≈ 2,11 m
Ridge height	≈ 2,45 m
Front overhang	≈ 30 cm

WINDOWS & DOORS (DGP+*)

1 double door	124,4 x 185,0 cm
1 double window	98,5 x 133,6 cm
windows open inward	

PACKAGING: 1 PALLET



440 x 118 x 65 cm
798 kg



*DGP+ - Double Glazed Premium

ROOF & FLOOR

Roof/Floor boards	18 mm
Roof surface	10.90 m ²
Roof slope	≈ 15.6°
Treated Bearers	70 x 45 mm

* Optional Roof Covering available



250 x 300

ALEX 70

7010940

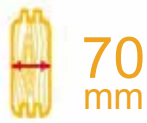

70 mm



1



5



5 YEARS

UNDER 2,5 metres

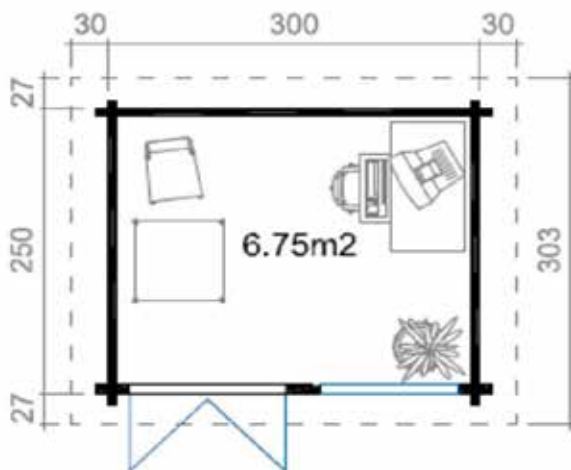

Mirroring option

DIMENSIONS

Floor Area	6.75 m ²
Roof dimensions	2x1.6x3.6
Cubic volume	≈ 15 m ³
Wall height	≈ 2,04 m
Ridge height	≈ 2,45 m
Front overhang	≈ 30 cm

WINDOWS & DOORS (DGP+*)

1 double door	134,0 x 186,5 cm
2 double window	110,0 x 132,0 cm

windows are inward opening tilt and turn

*DGP+ - Double Glazed Premium Plus

PACKAGING: 1 PALLET



440 x 115 x 70 cm
1030 kg

ROOF & FLOOR

Roof boards	18 mm
Floor boards	18 mm
Roof surface	11.52 m ²
Roof slope	≈ 18.1°
Treated Bearers	70 x 45 mm

* Optional Roof Covering available



ALEX MINI

4416540

250 x 200



 44 mm
 1
 4
☆☆☆
GUARANTEE
5
YEARS
UNDER
2,5
metres

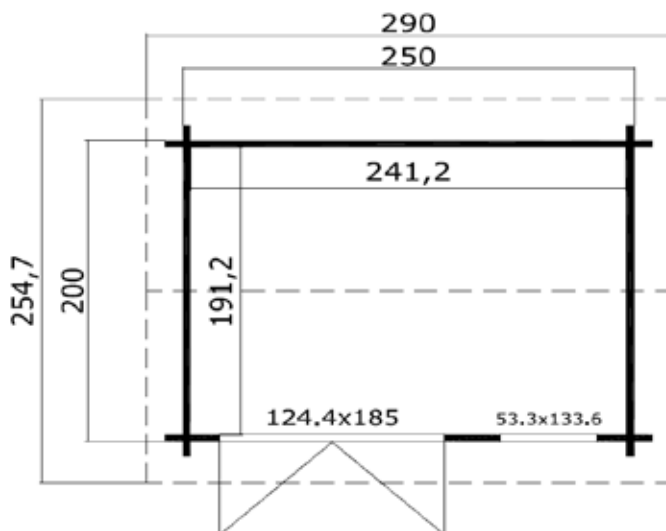

PACKAGING: 1 PALLET



330 x 118 x 65 cm
611 kg



DIMENSIONS

Floor Area	4.61 m ²
Roof dimensions	2,90 x 2,55 m
Cubic volume	≈ 10,5 m ³
Wall height	≈ 2,11 m
Ridge height	≈ 2,45 m
Front overhang	≈ 27 cm

WINDOWS & DOORS (DGP+A+*)

1 double door	124,4 x 185,0 cm
1 single window	53,3 x 133,6 cm
windows open inward	

*DGP+A+ - Double Glazed Premium

ROOF & FLOOR

Roof/Floor boards	18 mm
Roof surface	8.02 m ²
Roof angle	≈ 19,4°
Treated Bearers	70 x 45 mm

* Optional Roof Covering available



339 x 519

BARBADOS 2

4414502



44 mm



2

★ ★ ★
GUARANTEE

2-5
YEARS

UNDER
2,5
metres

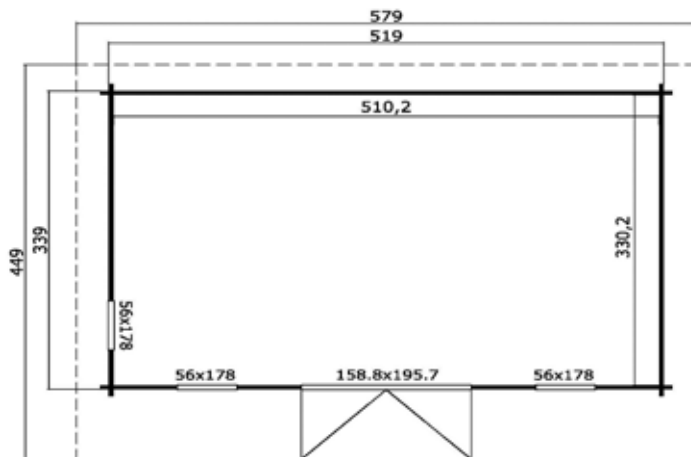

DIMENSIONS

Floor Area	16.85 m ²
Roof dimensions	4,49 x 5,79 m
Cubic volume	≈ 37,5 m ³
Wall height	≈ 2,11 m
Ridge height	≈ 2,38 m
Front overhang	≈ 80 cm

WINDOWS & DOORS (DGP+*)

1 double door	158,8 x 195,7 cm
3 single windows	56,0 x 178,0 cm
windows open inward	

PACKAGING: 1 PALLET



630 x 118 x 66 cm
1365 kg



*DGP+ - Double Glazed Premium

ROOF & FLOOR

Roof/Floor boards	18 mm
Roof surface	26.06 m ²
Roof slope	≈ 3,9°
Treated Bearers	45 x 70 mm

* *Optional Roof Covering available*

BARBADOS 3

4414602

399 x 309



44
mm



2

GUARANTEE

2-5
YEARS

UNDER
2,5
metres

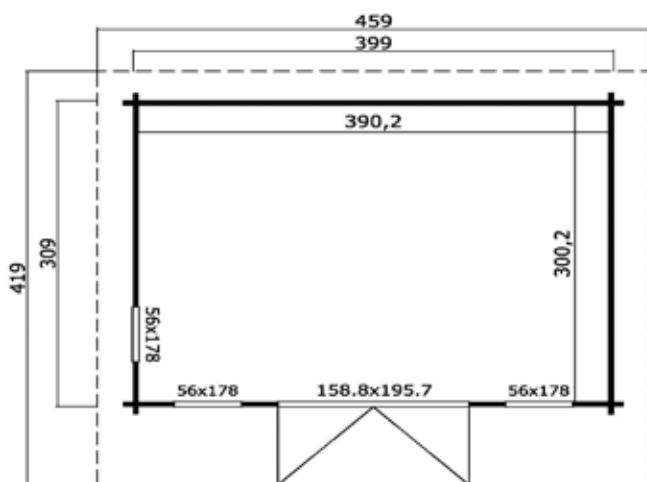

DIMENSIONS

Floor Area	11.71 m ²
Roof dimensions	4,19 x 4,59 m
Cubic volume	≈ 26,04 m ³
Wall height	≈ 2,11 m
Ridge height	≈ 2,34 m
Front overhang	≈ 80 cm

WINDOWS & DOORS (DGP+*)

1 double door	158,8 x 195,7 cm
3 single windows	56,0 x 178,0 cm
windows open inward	

PACKAGING: 1 PALLET



630 x 118 x 58 cm
1128 kg



*DGP+ - Double Glazed Premium Plus

ROOF & FLOOR

Roof/Floor boards	18 mm
Roof surface	19.29 m ²
Roof slope	≈ 4,3°
Treated Bearers	45 x 70 mm

* Optional Roof Covering available

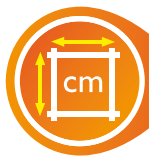

309 x 399

BARBADOS 3 70

7011602

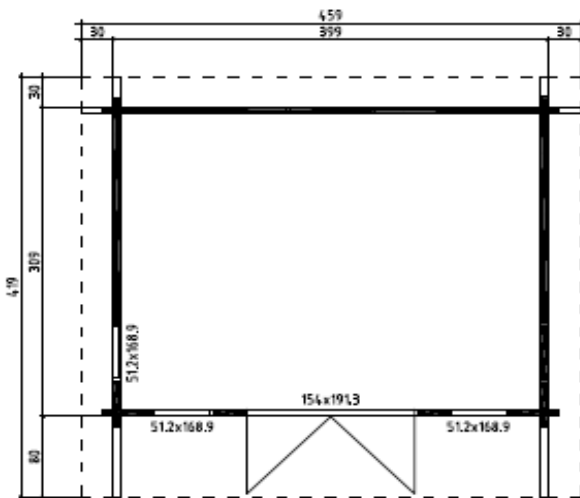
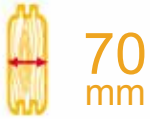

DIMENSIONS

Floor Area	11,36 m ²
Roof dimensions	4.59x4.22 m
Cubic volume	26.3 m ³
Wall height	≈ 2.18 m
Ridge height	≈ 2.45 m
Front overhang	≈ 80 cm

WINDOWS (2+ quality) & DOORS (2+ quality)

1 double door extern.	158.0 x 193.3 cm
3 single windows	55.2 x 172.9 cm

windows are inward opening tilt and turn

PACKAGING: 1 PALLET



630 x 115 x 70 cm
1470 kg

ROOF & FLOOR

Roof boards	18 mm
Floor boards	18 mm
Roof surface	19,37 m ²
Roof slope	5°
Treated Bearers	70x45 mm
* <i>Optional Roof Covering available</i>	



BARBADOS 3 TWIN

443780

309 x 399

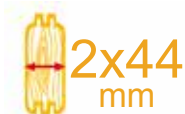

2x44 mm



3



-

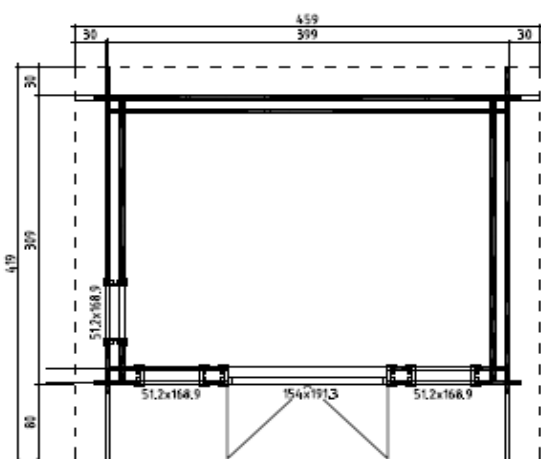

DIMENSIONS

Floor Area	9,81 m ²
Roof dimensions	4.59x4.22 m
Cubic volume	26.1 m ³
Wall height	≈ 2.04 m
Ridge height	≈ 2.31 m
Front overhang	≈ 80 cm

WINDOWS (2+ quality) & DOORS (2+ quality)

1 double door extern.	158.0 x 193.3 cm
3 single windows	55.2 x 172.9 cm

windows are inward opening tilt and turn

PACKAGING: 1 PALLET



630 x 115 x 85 cm
1786 kg



ROOF & FLOOR

Roof boards	18 mm
Floor boards	18 mm
Roof surface	19,37 m ²
Roof slope	5°
Treated Bearers	45 x 70 mm

* Optional Roof Covering available



240 x 330

BARBADOS MINI

4415040



44 mm



2

GUARANTEE

2-5
YEARS

UNDER
2,5
metres

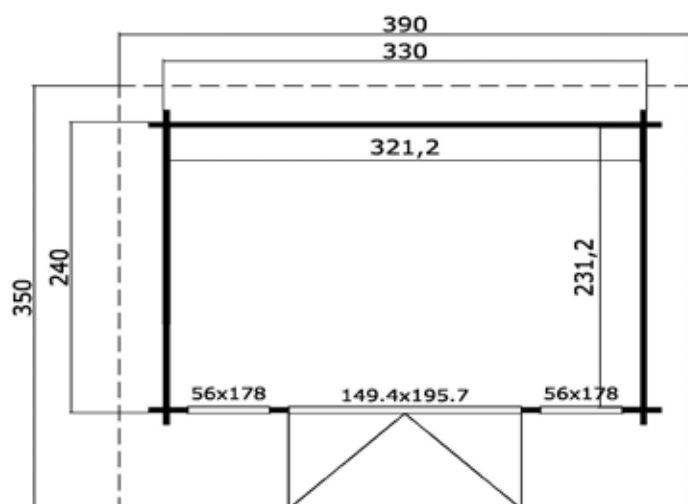

DIMENSIONS

Floor Area	7.43 m ²
Roof dimensions	3,50 x 3,90 m
Cubic volume	≈ 16,51 m ³
Wall height	≈ 2,11 m
Ridge height	≈ 2,34 m
Front overhang	≈ 80 cm

WINDOWS & DOORS (DGP+*)

1 double door	149,4 x 195,7 cm
2 single windows	56,0 x 178,0 cm
windows open inward	

*DGP+ - Double Glazed Premium

ROOF & FLOOR

Roof/Floor boards	18 mm
Roof surface	13.71 m ²
Roof slope	≈ 5,5°
Treated Bearers	45 x 70 mm

* *Optional Roof Covering available*

PACKAGING: 1 PALLET



440 x 118 x 65 cm
886 kg



BARBADOS MINI 70

7010802

240 x 330



70 mm



2



-

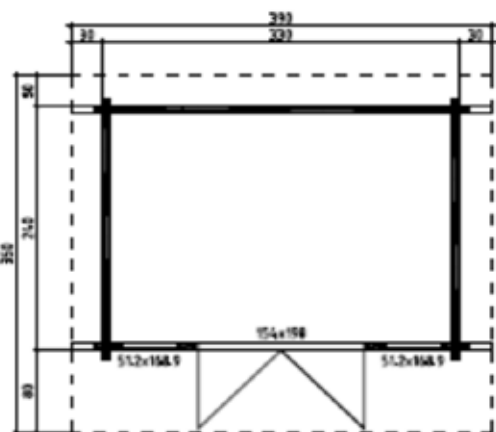

Mirroring option

PACKAGING: 1 PALLET



440 x 115 x 82 cm
1203 kg

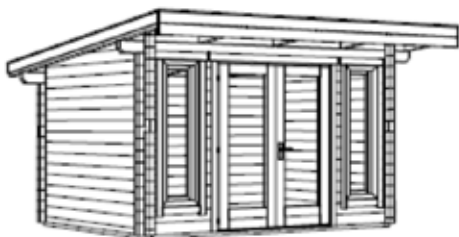

DIMENSIONS

Floor Area	7.14 m ²
Roof dimensions	1x3.54x3.9
Cubic volume	≈ 15.54 m ³
Wall height	≈ 2,04 m
Ridge height	≈ 2,312 m
Front overhang	≈ 30 cm

WINDOWS & DOORS (DGP+*)

1 double door	158,0 x 200,0 cm
2 single windows	552,0 x 172,9 cm

windows are inward opening tilt and turn

*DGP+ - Double Glazed Premium Plus

ROOF & FLOOR

Roof boards	18 mm
Floor boards	18 mm
Roof surface	13.81 m ²
Roof slope	≈ 6.5°
Treated Bearers	70 x 45 mm

* *Optional Roof Covering available*



330 x 510

BARUDA 53

407999



40 mm



2



10

GUARANTEE

5

YEARS

UNDER
2,5
metres

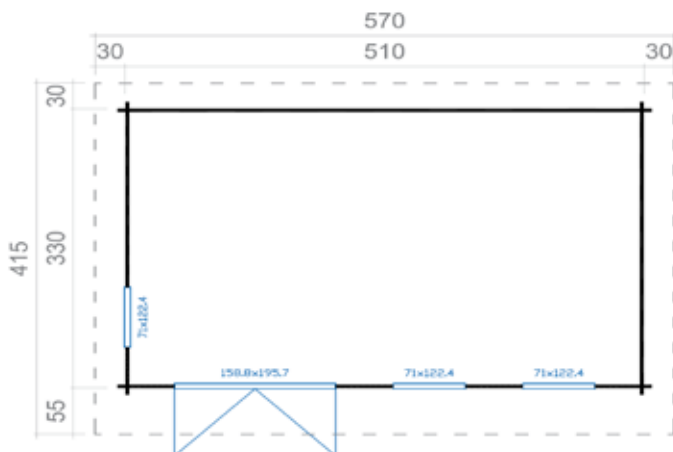

DIMENSIONS

Floor Area	16.16 m ²
Roof dimensions	4,15 x 5,70 m
Cubic volume	≈ 33,2 m ³
Wall height	≈ 1,88 m
Ridge height	≈ 2,23 m
Front overhang	≈ 55 cm

WINDOWS & DOORS (DGP+*)

1 double door	158,8 x 195,7 cm
3 single windows	71,0 x 124,4 cm
windows open inward	

*DGP+ - Double Glazed Premium

ROOF & FLOOR

Roof/Floor boards	18 mm
Roof surface	23.79 m ²
Roof slope	≈ 6,1°
Treated Bearers	45 x 70 mm

* *Optional Roof Covering available*

PACKAGING: 1 PALLET



630 x 118 x 60 cm
1221 kg





★ ★ ★
GUARANTEE

5
YEARS

UNDER
2,5
metres

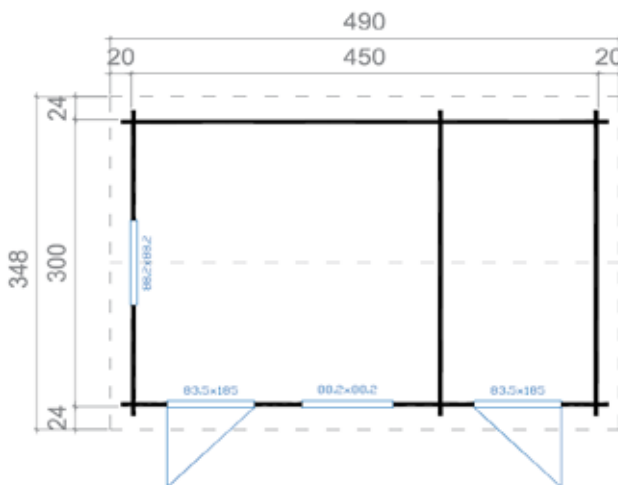

DIMENSIONS

Floor Area	12,85 m ²
Roof dimensions	4,90 x 3,48 m
Cubic volume	≈ 28,19 m ³
Wall height	≈ 2,00 m
Ridge height	≈ 2,39 m
Front overhang	≈ 24 cm

WINDOWS & DOORS (DGP+)

1 single door	83,5 x 185,0 cm
1 single door	83,5 x 185,0 cm
2 single windows	88,2 x 88,2 cm

Inward opening windows

Double seals on windows

3 way adjustable door hinges

European Quality Window & Door Furniture

DGP+ Double Glazed Premium Plus

ROOF & FLOOR

Roof/Floor boards	18 mm
Roof surface	17,64 m ²
Roof slope	≈ 15,1°
Treated Bearers	45 x 70 mm

* Optional Roof Covering available

PACKAGING: 1 PALLET



630 x 118 x 66 cm
1200 kg





520 x 370

BRIGHTON 44

4416902



44 mm



2



10

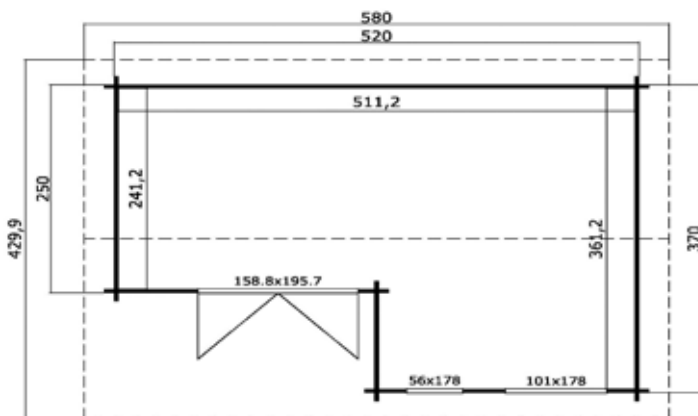

DIMENSIONS

Floor Area	16.12 m ²
Roof dimensions	5,80 x 4,30 m
Cubic volume	≈ 36,75 m ³
Wall height	≈ 2,11 m
Ridge height	≈ 2,51 m
Front overhang	≈ 30 cm

WINDOWS & DOORS (DGP+*)

1 double door	158,8 x 195,7 cm
1 single window	56,0 x 178,0 cm
1 fix window	101,0 x 178,0 cm

windows open inward

*DGP+ - Double Glazed Premium

ROOF & FLOOR

Roof/Floor boards	18 mm
Roof surface	25.74 m ²
Roof angle	≈ 12,3°
Treated Bearers	45 x 45 mm

* Optional Roof Covering available

PACKAGING: 1 PALLET



630 x 118 x 68 cm
1288 kg



CARDIFF

4421902

380 x 380



UNDER
2,5
metres

★ ★ ★
GUARANTEE
2-5
YEARS

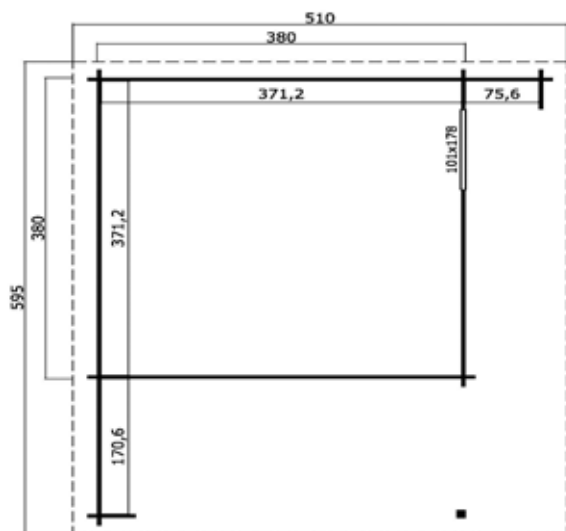

PACKAGING: 1 PALLET



630 x 118 x 90 cm
2117 kg



DIMENSIONS

Floor Area	13.78 m ²
Roof dimensions	5.10 x 5.95 m
Cubic volume	≈ 32.99 m ³
Wall height	≈ 2.34 m
Ridge height	≈ 2.45 m
Front overhang	≈ 105 cm

WINDOWS & DOORS (DGP+*)

1 double door	158.8 x 195.7 cm
2 single windows	56.0 x 178.0 cm
1 double non-opening window	101.0 x 178.0 cm

*DGP+ - Double Glazed Premium

ROOF & FLOOR

Roof/Floor boards	18 mm
Roof surface	25.50 m ²
Roof angle	≈ 1.4°
Treated Bearers	45 x 45 mm
Terrace boards	19 mm

* Optional Roof Covering available



350 x 300

CARLISLE

405602



40 mm



2



7

★ ★ ★
GUARANTEE

5
YEARS

UNDER
2,5
metres

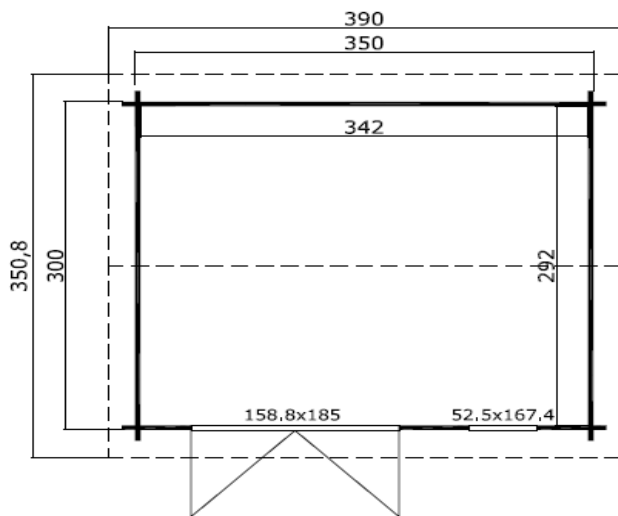

PACKAGING: 1 PALLET



440 x 118 x 64 cm
896 kg



DIMENSIONS

Floor Area	9.99 m ²
Roof dimensions	3,90 x 3,51 m
Cubic volume	≈ 22,8 m ³
Wall height	≈ 2,11 m
Ridge height	≈ 2,45 m
Front overhang	≈ 25 cm

WINDOWS & DOORS (DGP+*)

1 double door	158,8 x 185,0 cm
1 single window	52,5 x 167,4 cm
windows open inward	

*DGP+ - Double Glazed Premium

ROOF & FLOOR

Roof/Floor boards	18 mm
Roof surface	14.04 m ²
Roof slope	≈ 13,0°
Treated Bearers	70 x 45 mm

* Optional Roof Covering available

DORSET 34

348902

390 x 250



☆☆☆
GUARANTEE

5
YEARS

UNDER
2,5
metres

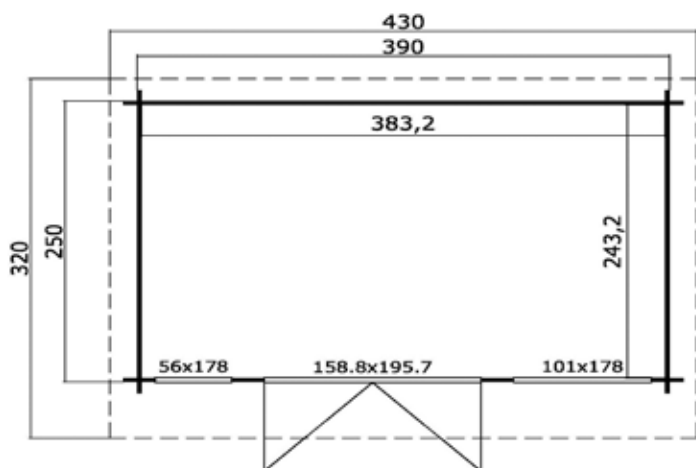

DIMENSIONS

Floor Area	9.32 m ²
Roof dimensions	4,30 x 3,20
Cubic volume	≈ 20,7 m ³
Wall height	≈ 2,11 m
Ridge height	≈ 2,34 m
Front overhang	≈ 50 cm

WINDOWS & DOORS (DGP+*)

1 double door	158,8 x 195,7 cm
1 single window	56,0 x 178,0 cm
1 fixed window	101,0 x 178,0 cm
windows open inward	

*DGP+ - Double Glazed Premium

ROOF & FLOOR

Roof/Floor boards	18 mm
Roof surface	13.80 m ²
Roof slope	≈ 5,3°
Treated Bearers	45 x 70 mm

* *Optional Roof Covering available*

PACKAGING: 1 PALLET



440 x 118 x 65 cm
860 kg





250 x 400

DORSET 71

7095022

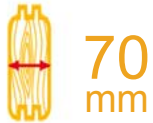

70 mm



2



-

☆☆☆
GUARANTEE

5
YEARS

UNDER
2,5
metres

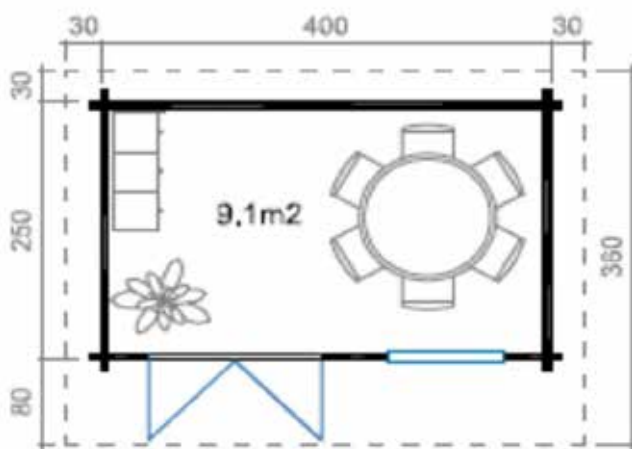

Mirroring option

PACKAGING: 1 PALLET



450 x 115 x 85 cm
1276 kg



DIMENSIONS

Floor Area	9.11 m ²
Roof dimensions	3,60 x 4,60
Cubic volume	≈ 21.1 m ³
Wall height	≈ 2,25 m
Ridge height	≈ 2,38 m
Front overhang	≈ 80 cm

WINDOWS & DOORS (DGP+*)

1 double door	158,0 x 193,3 cm
1 double window	110,0 x 172,9 cm

window is inward opening tilt and turn

*DGP+ - Double Glazed Premium Plus

ROOF & FLOOR

Roof boards	18 mm
Floor boards	18 mm
Roof surface	16.70 m ²
Roof slope	≈ 3.1°
Treated Bearers	70 x 45 mm

* Optional Roof Covering available

DORSET 72

709602

250 x 450

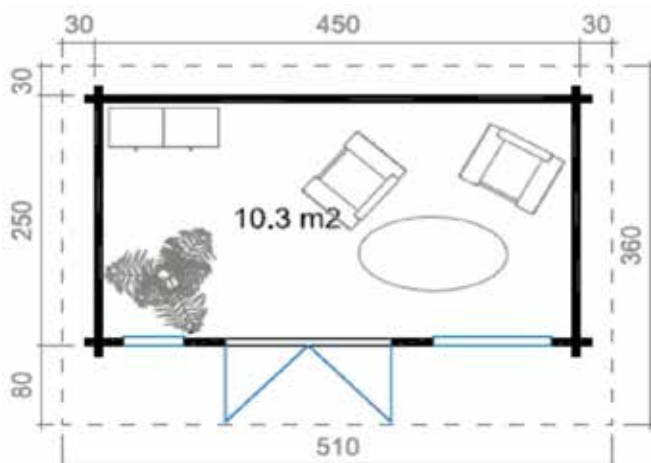

Mirroring option

DIMENSIONS

Floor Area	10.30 m ²
Roof dimensions	3,60 x 5,10
Cubic volume	≈ 23.8 m ³
Wall height	≈ 2,25 m
Ridge height	≈ 2,38 m
Front overhang	≈ 80 cm

WINDOWS & DOORS (DGP+*)

1 double door	158,0 x 193,3 cm
1 double window	110,0 x 172,9 cm
1 single window	55,2x172,9 cm
window is inward opening tilt and turn	

PACKAGING: 1 PALLET



630 x 115 x 77 cm
1617 kg



*DGP+ - Double Glazed Premium Plus

ROOF & FLOOR

Roof boards	18 mm
Floor boards	18 mm
Roof surface	18.50 m ²
Roof slope	≈ 3.1°
Treated Bearers	70 x 45 mm

* *Optional Roof Covering available*



250 x 480

DORSET 73

709702

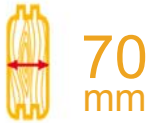

70 mm



2



-

★ ★ ★
GUARANTEE

5

YEARS

UNDER
2,5
metres

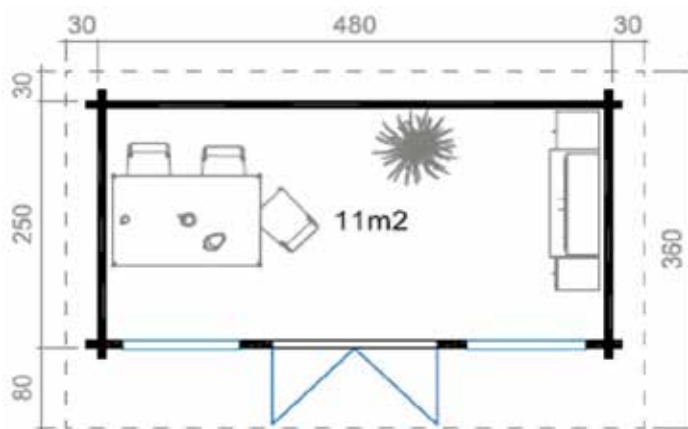

Mirroring option

PACKAGING: 1 PALLET



630 x 115 x 82 cm
1723 kg



DIMENSIONS

Floor Area	11.00 m ²
Roof dimensions	3,60 x 5,10
Cubic volume	≈ 25.4 m ³
Wall height	≈ 2,25 m
Ridge height	≈ 2,38 m
Front overhang	≈ 80 cm

WINDOWS & DOORS (DGP+*)

1 double door	158,0 x 193,3 cm
2 double window	110,0 x 172,9 cm

window is inward opening tilt and turn

*DGP+ - Double Glazed Premium Plus

ROOF & FLOOR

Roof boards	18 mm
Floor boards	18 mm
Roof surface	19.60 m ²
Roof slope	≈ 3.1°
Treated Bearers	70 x 45 mm

* Optional Roof Covering available

DUNDEE 44

4419802

370 x 575

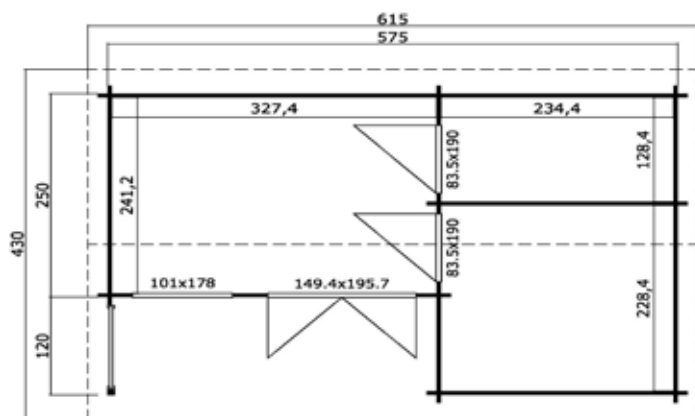

DIMENSIONS

Floor Area	16.47 m ²
Roof dimensions	4.30 x 6.15 m
Cubic volume	38.02
Wall height	≈ 2.11 m
Ridge height	≈ 2.51 m
Front overhang	≈ 30 cm

WINDOWS & DOORS (DGP+*)

1 double door	149.4 x 195.7 cm
2 single doors	83.5 x 190.0 cm
2 single windows	54.0 x 54.0 cm
1 fix window	101.0 x 178.0 cm

*DGP+ - Double Glazed Premium

PACKAGING: 1 PALLET



≈ 630 x 118 x 81.5 cm
≈ 1812 kg



ROOF & FLOOR

Roof/Floor boards	18 mm
Roof surface	27.06 m ²
Roof angle	≈ 12.3°
Treated Bearers	45 x 45 mm
Terrace boards	19 mm

* Optional Roof Covering available



608 x 390

JAVA 44

4415802



★ ★ ★
GUARANTEE

5
YEARS

UNDER
2,5
metres

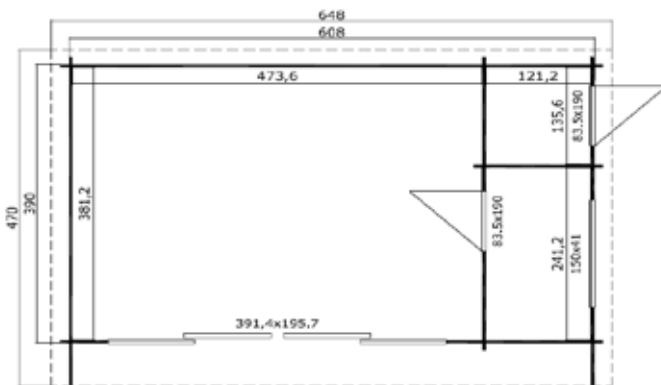

DIMENSIONS

Floor Area	22.84 m ²
Roof dimensions	6,48 x 4,70 m
Cubic volume	≈ 53,38 m ³
Wall height	≈ 2,22 m
Ridge height	≈ 2,45 m
Front overhang	≈ 60 cm

WINDOWS & DOORS (DGP+*)

1 sliding door	391,4 x 195,7 cm
2 single doors	83,5 x 190,0 cm
1 single fix window	150,0 x 41,0 cm
window not opened	

*DGP+ - Double Glazed Premium

ROOF & FLOOR

Roof/Floor boards	18 mm
Roof surface	30.51 m ²
Roof angle	≈ 3,4°
Treated Bearers	70 x 45 mm

* *Optional Roof Covering available*

PACKAGING: 1 PALLET



630 x 118 x 100 cm
2350 kg



JUBILEE 44

4411202

350 x 300



44 mm



2



7

☆☆☆
GUARANTEE

5
YEARS

UNDER
2,5
metres

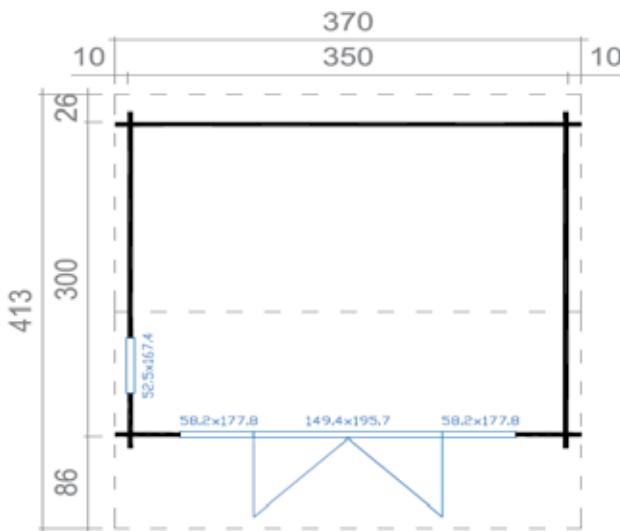

PACKAGING: 1 PALLET



440 x 118 x 73 cm
991 kg



DIMENSIONS

Floor Area	9.94 m ²
Roof dimensions	3.70 x 4.13 m
Cubic volume	≈ 23.22 m ³
Wall height	≈ 2.22 m
Ridge height	≈ 2.45 m
Front overhang	≈ 86 cm

WINDOWS & DOORS (DGP+*)

1 double door	265.8 x 195.7 cm
1 single window	52.5 x 167.4 cm
windows open inward	

*DGP+ - Double Glazed Premium

ROOF & FLOOR

Roof/Floor boards	18 mm
Roof surface	15.54 m ²
Roof angle	≈ 10,8°
Treated Bearers	70 x 45 mm

* Optional Roof Covering available



400 x 550

LYNDHURST 70

7011902



70 mm



7

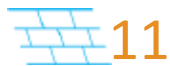

11



GUARANTEE

5

YEARS

UNDER
2,5
metres

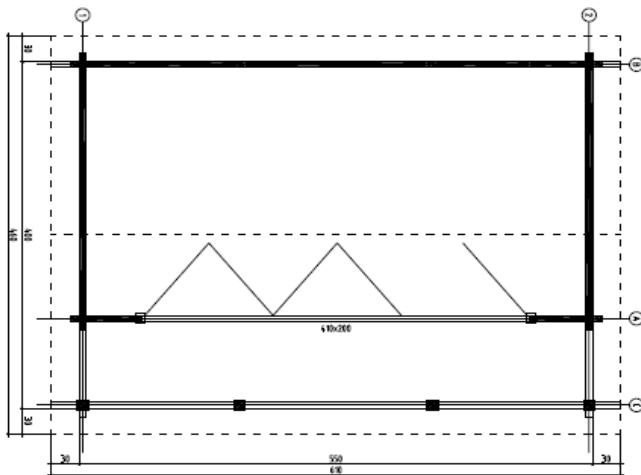

Mirroring option

DIMENSIONS

Floor Area	15,33 m ²
Roof dimensions	2x2,37x6,1
Cubic volume	≈ 35,96 m ³
Wall height	≈ 2,24 m
Ridge height	≈ 2,45 m
Front overhang	≈ 30 cm

WINDOWS & DOORS (2+ quality class)

1 bi-folding door	410,0 x 200,0 cm
-------------------	------------------

PACKAGING: 2 PALLETS



660 x 115 x 85 cm

1871 kg

200 x 115 x 65 cm

434 kg

ROOF & FLOOR

Roof boards	18 mm
Floor boards	18 mm
Roof surface	28,88 m ²
Roof slope	≈ 8°
Treated Bearers	70 x 45 mm

* *Optional Roof Covering available*



MONTROSE 44

4419902

370 x 575

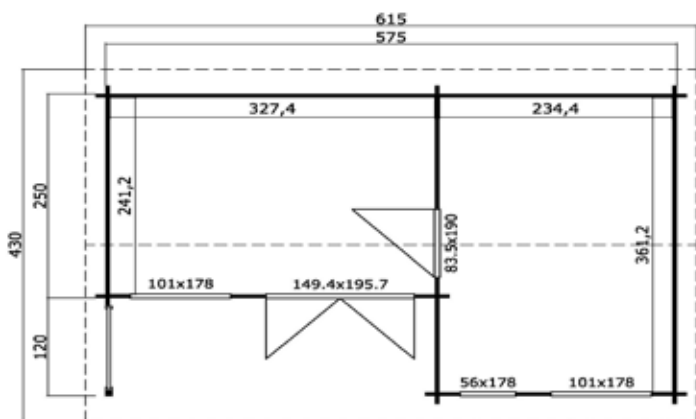

DIMENSIONS

Floor Area	16.47 m ²
Roof dimensions	4.30 x 6.15 m
Cubic volume	38.02
Wall height	≈ 2.11 m
Ridge height	≈ 2.51 m
Front overhang	≈ 30 cm

WINDOWS & DOORS (DGP+*)

1 double door	149.4 x 195.7 cm
1 single door	83.5 x 190.0 cm
1 single window	56.0 x 178.0 cm
2 fix windows	101.0 x 178.0 cm

*DGP+ - Double Glazed Premium

PACKAGING: 1 PALLET



≈ 630 x 118 x 76 cm

≈ 1648 kg



ROOF & FLOOR

Roof/Floor boards	18 mm
Roof surface	27.06 m ²
Roof angle	≈ 12.3°
Treated Bearers	45 x 45 mm
Terrace boards	19 mm

* Optional Roof Covering available



390 x 520

ORKNEY I

704102

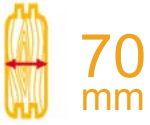

70 mm



3



-

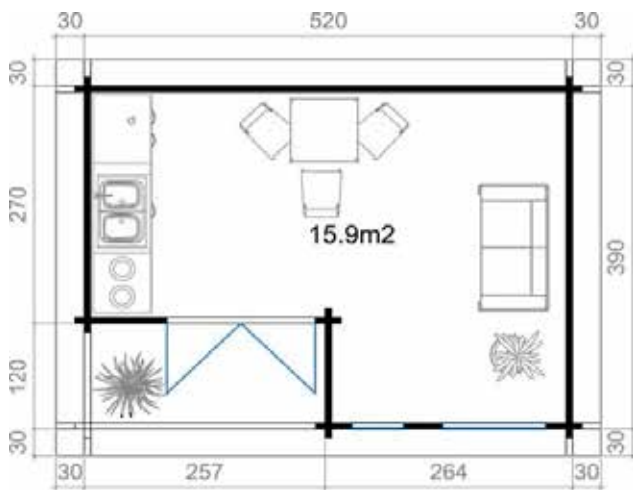

Mirroring option

DIMENSIONS

Floor Area	15.90 m ²
Roof dimensions	4,50 x 5,80
Cubic volume	≈ 38 m ³
Wall height	≈ 2,31 m
Ridge height	≈ 2,45 m
Front overhang	≈ 30 cm

WINDOWS & DOORS (DGP+*)

1 double door	158,0 x 200,0 cm
1 double window	110,0 x 172,9 cm
1 single window	55,2 x 172,9 cm

windows open inward, tilt and turn

*DGP+ - Double Glazed Premium Plus

PACKAGING: 1 PALLET



630 x 115 x 101 cm
2195 kg

ROOF & FLOOR

Roof boards	18 mm
Floor boards	28 mm
Ceiling boards	15 mm
Terrace boards	28 mm
Roof surface	26.20 m ²
Roof slope	≈ 2°
Treated Bearers	70 x 45 mm

* Optional Roof Covering available



ORKNEY 4

704542

390 x 610



70
mm



3



-

★ ★ ★
GUARANTEE

5
YEARS

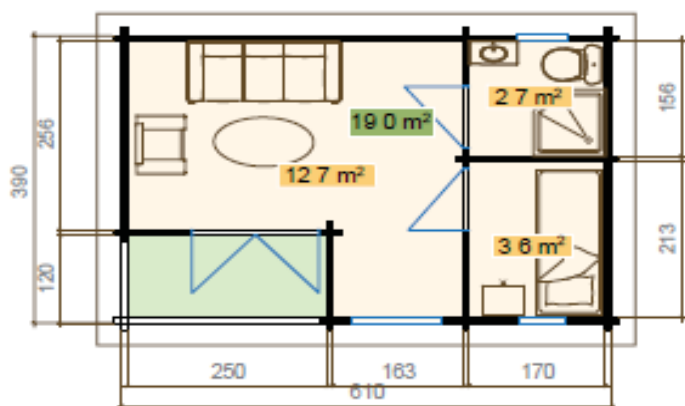

DIMENSIONS

Floor Area	19,10 m ²
Roof dimensions	6,7x4,5
Cubic volume	≈ 45,50 m ³
Wall height	≈ 2,31 m
Ridge height	≈ 2,45 m
Front overhang	≈ 30 cm

WINDOWS & DOORS (2+ quality class)

1 double door	158,0 x 200,0 cm
2 single doors int.	82,7 x 200,0 cm
1 double window	110,0x172,9 cm
1 single window	55,2 x 172,9 cm

windows are inward opening tilt and turn

PACKAGING: 3 PALLETS



650 x 115 x 90 cm	2018 kg
480 x 115 x 90 cm	1490 kg
220 x 115 x 80 cm	607 kg

ROOF & FLOOR

Roof boards	18 mm
Floor boards	28 mm
Roof surface	30,20 m ²
Roof slope	≈ 2°
Treated Bearers	45x96 mm

* *Optional Roof Covering available*





300 x 600

SHETLAND 2

7011202



70 mm



2



10

★ ★ ★
GUARANTEE

5

YEARS

UNDER
2,5
metres

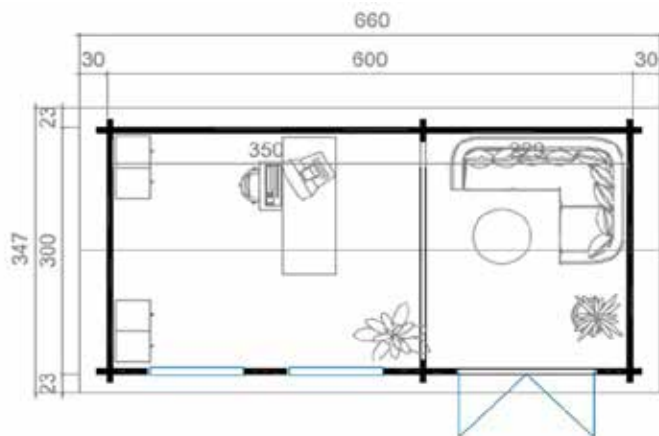

Mirroring option

PACKAGING: 1 PALLET



660 x 115 x 85 cm
1871 kg



DIMENSIONS

Floor Area	16.70 m ²
Roof dimensions	2x1.8x6.6
Cubic volume	≈ 37.6 m ³
Wall height	≈ 2,04 m
Ridge height	≈ 2,45 m
Front overhang	≈ 30 cm

WINDOWS & DOORS (DGP+*)

1 double door	158,0 x 186,5 cm
2 double window	110,0 x 172,9 cm

windows are inward opening tilt and turn

*DGP+ - Double Glazed Premium Plus

ROOF & FLOOR

Roof boards	18 mm
Floor boards	18 mm
Roof surface	23.70 m ²
Roof slope	≈ 15.2°
Treated Bearers	70 x 45 mm

* *Optional Roof Covering available*

SHETLAND 2 TWIN

4419780

300 x 600

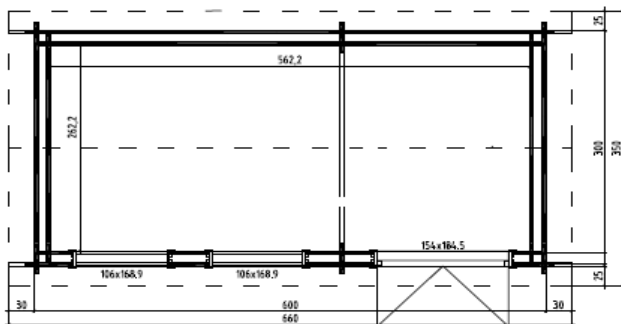

DIMENSIONS

Floor Area	14.74 m ²
Roof dimensions	2x1.8x6.6 m
Cubic volume	37.5 m ³
Wall height	≈ 2,0 m
Ridge height	≈ 2.5 m
Front overhang	≈ 30 cm

WINDOWS (2+ quality) & DOORS (2+ quality)

1 double door extern.	158.0 x 186.5 cm
2 double windows	110 x 172.9 cm

windows are inward opening tilt and turn

PACKAGING: 1 PALLET



660 x 115 x 90cm
1981 kg

ROOF & FLOOR

Roof boards	18 mm
Floor boards	18 mm
Roof surface	23.76 m ²
Roof slope	17.6°
Treated Bearers	70 x 45 mm

* *Optional Roof Covering available*





370 x 540

STAFFORDSHIRE I

7012402



70 mm



4



14

★ ★ ★
GUARANTEE

5
YEARS

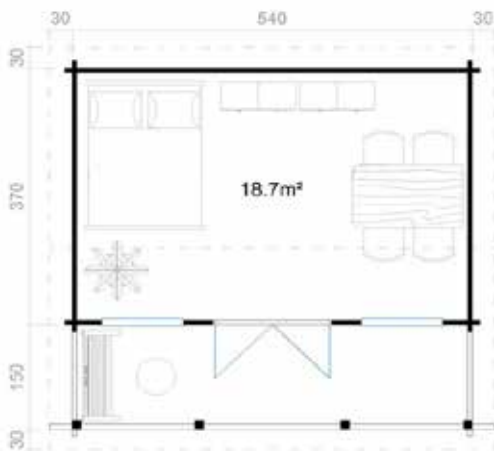

DIMENSIONS

Floor Area	18.73 m ²
Roof dimensions	2x3,067x6 m
Cubic volume	49,02 m ³
Wall height	≈ 2,18 m
Ridge height	≈ 3,06 m
Front overhang	≈ 180 cm

WINDOWS (2+ quality) & DOORS (2+ quality)

1 double door extern.	158,0 x 200,0 cm
2 double windows	120,0 x 132,0 cm

windows are inward opening tilt and turn

PACKAGING: 2 PALLETS



630x115x85 cm

1786 kg

450x115x82 cm

1201 kg

ROOF & FLOOR

Roof boards	18 mm
Floor boards	28 mm
Roof surface	36.80 m ²
Roof slope	19°
Treated Bearers	70x45 mm

* *Optional Roof Covering available*



STAFFORDSHIRE 2

7012502

370 x 540

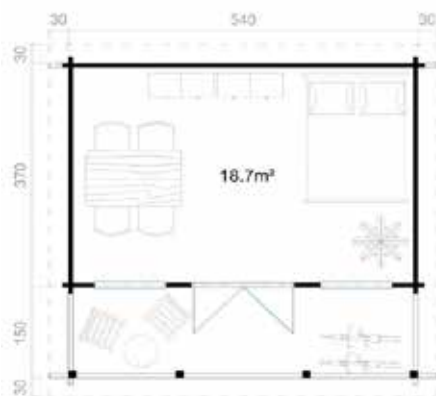

DIMENSIONS

Floor Area	18.73 m ²
Roof dimensions	3,976x6+1,865x6
Cubic volume	43,29 m ³
Wall height	≈ 2,18 m
Ridge height	≈ 2,45 m
Front overhang	≈ 150 cm

WINDOWS (2+ quality) & DOORS (2+ quality)

1 double door extern.	158,0 x 200,0 cm
2 double windows	120,0 x 132,0 cm

windows are inward opening tilt and turn

PACKAGING: 2 PALLETS



630x115x81 cm
1772 kg
450x115x82 cm
1201 kg



ROOF & FLOOR

Roof boards	18 mm
Floor boards	28 mm
Roof surface	35.05 m ²
Roof slope	10°
Treated Bearers	70x45 mm
* Optional Roof Covering available	



575 x 370

TORQUAY 44

4417502



44 mm



3



11

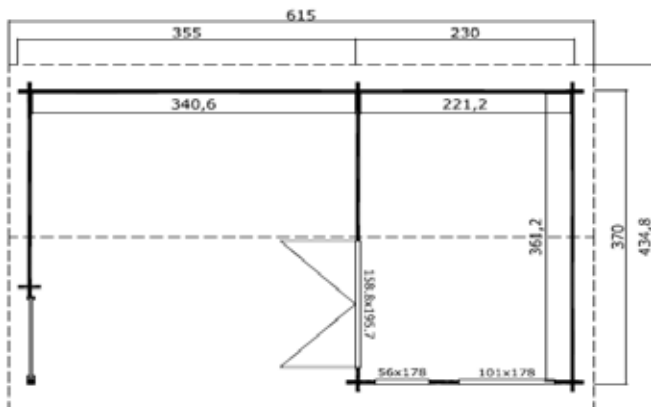

DIMENSIONS

Floor Area	20.45 m ²
Roof dimensions	6,15 x 4,35 m
Cubic volume	≈ 47,21 m ³
Wall height	≈ 2,17 m
Ridge height	≈ 2,45 m
Front overhang	≈ 32 cm

WINDOWS & DOORS (DGP+*)

1 double door	158,8 x 195,7 cm
1 single window	56,0 x 178,8 cm
1 fix window	101,0 x 178,8 cm

windows open inward

PACKAGING: 1 PALLET



630 x 118 x 69 cm
1482 kg



*DGP+ - Double Glazed Premium

ROOF & FLOOR

Roof/Floor boards	18 mm
Roof surface	27.06 m ²
Roof angle	≈ 8,8°
Treated Bearers	45 x 45 mm

* Optional Roof Covering available



▲ **BERKSHIRE 43**
PAGE 58



▲ **DEVONSHIRE 43**
PAGE 63



▲ **EDINBURGH 140**
PAGE 65



◀ **WINDSOR 44**
PAGE 81

CLASSIC



▲ ANGUILLITA
PAGE 56



ANGUILLA
 PAGE 55
 402402  390 x 510



ANGUILLITA
 PAGE 56
 402502  390 x 300



BALMORAL
 PAGE 57
 4417040  380 x 530



BERKSHIRE 43
 PAGE 58
 4413340  380 x 280



BERKSHIRE 53
 PAGE 59
 4414840  480 x 280



BORKUM 4
 PAGE 60
 407102  485 x 300



CAPRI 44
 PAGE 61
 441599  300 x 300



CHAMELEON 44
 PAGE 62
 4420002  450 x 300



DEVONSHIRE 43
 PAGE 63
 4413140  380 x 280



DEVONSHIRE 54
 PAGE 64
 4413240  480 x 380



EDINBURGH 140
 PAGE 65
 407540  280 x 280



EDINBURGH 240
 PAGE 66
 407640  280 x 488

*Our classic range compliments both
modern and traditional
environments*



ELGIN 44

PAGE 67
4415902



480 x 0



EXETER 1

PAGE 68
7012202



524 x 390



EXETER 2

PAGE 69
7012302



397 x 390



INVERNESS 44

PAGE 70
4416002



280 x 242



KENSINGTON

PAGE 71
4414340



400 x 246



MAURITIUS 44

PAGE 72
446794



330 x 510



NEWBURY

PAGE 73
4421402



350 x 350



OBAN 40

PAGE 74
408940



240 x 240



OXFORDSHIRE 53

PAGE 75
4414002



480 x 280



PEMBROKESHIRE 53

PAGE 76
4414740



480 x 280



PORTSMOUTH 44

PAGE 77
4420102



400 x 400



RIVIERA 44

PAGE 78
4416802



350 x 303



WARWICKSHIRE 53

PAGE 79
4413040



480 x 280



WINDSOR MINI

PAGE 80
4421102



250 x 300



WINDSOR 44

PAGE 81
4415240



300 x 400



WREXHAM 1

PAGE 82
4416602



390 x 240



WREXHAM 2

PAGE 83
4416740



485 x 300



BIKE SHELTERS 2000

PAGE 84
288700



150 x 200



BIKE SHELTERS 2600

PAGE 85
288600



150 x 260



BIKE EXTENSION 2000

PAGE 86
2829200



200 x 120



BIKE EXTENSION 2600

PAGE 87
2829600



260 x 140



390 x 510

ANGUILLA

402402



40 mm



2



10

★ ★ ★
GUARANTEE

2-5
YEARS

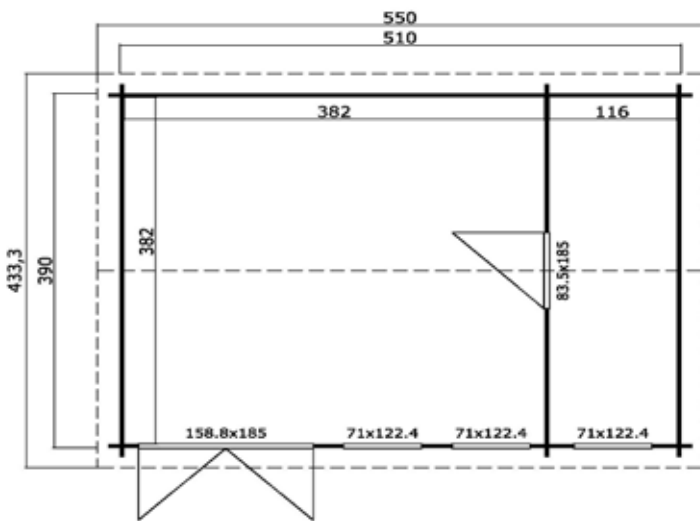

DIMENSIONS

Floor Area	19.18 m ²
Roof dimensions	4.33 x 5.50 m
Cubic volume	≈ 43.72 m ³
Wall height	≈ 2.11 m
Ridge height	≈ 2.45 m
Front overhang	≈ 21.7 cm

WINDOWS & DOORS (DGP+*)

1 double door	158.8 x 185.0 cm
1 single door	83.5 x 185.0 cm
3 single windows	71.0 x 122.4 cm

windows open inward

*DGP+ - Double Glazed Premium

PACKAGING: 1 PALLET



≈ 560 x 118 x 84.5 cm
≈ 1520 kg

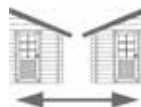

ROOF & FLOOR

Roof / Floor boards	18 mm
Roof surface	24.20 m ²
Roof angle	≈ 10°
Treated Bearers	70x45

* Optional Roof Covering available

ANGUILLITA

402502

390 x 300



★ ★ ★
GUARANTEE

2-5
YEARS

UNDER
2,5
metres

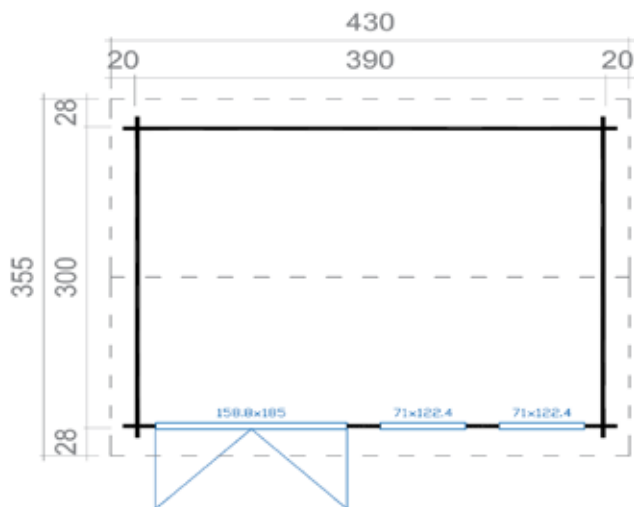

PACKAGING: 1 PALLET

440 x 118 x 70 cm
955 kg



DIMENSIONS

Floor Area	11.15 m ²
Roof dimensions	4,30 x 3,55 m
Cubic volume	≈ 25,4 m ³
Wall height	≈ 2,11 m
Ridge height	≈ 2,45 m
Front overhang	≈ 28 cm

WINDOWS & DOORS (DGP+*)

1 double door	158,8 x 185,0 cm
2 single windows	71,0 x 122,4 cm
windows open inward	

*DGP+ - Double Glazed Premium Plus

ROOF & FLOOR

Roof/Floor boards	18 mm
Roof surface	15.48 m ²
Roof slope	≈ 13,0°
Treated Bearers	70 x 45 mm

* Optional Roof Covering available



380 x 530

BALMORAL 44

4417040



44 mm



3



10

★ ★ ★
GUARANTEE

5
YEARS

UNDER
2,5
metres

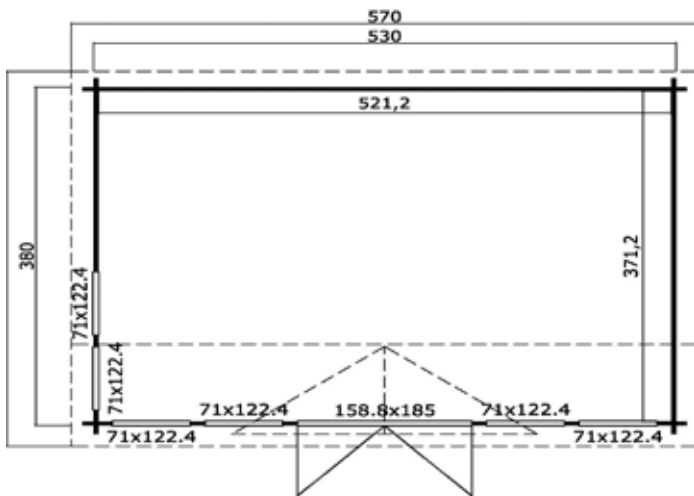

DIMENSIONS

Floor Area	19.35 m ²
Roof dimensions	4.21 x 5.7 m
Cubic volume	≈ 42.42 m ³
Wall height	≈ 1.99 m
Ridge height	≈ 2.39 m
Front overhang	≈ 20 cm

WINDOWS & DOORS (DGP+*)

1 double door	158.8 x 185.0 cm
6 single window	71.0 x 122.4 cm

windows open inward

*DGP+ - Double Glazed Premium

PACKAGING: 1 PALLET



630 x 118 x 82 cm
1440 kg



ROOF & FLOOR

Roof/Floor boards	18 mm
Roof surface	25.81 m ²
Roof angle	≈ 7.9° / 17.9° / 12.8°
Treated Bearers	70 x 45 mm

* Optional Roof Covering available

BERKSHIRE 43

4413340

380 x 280



44 mm



2



7



5

YEARS

UNDER
2,5
metres

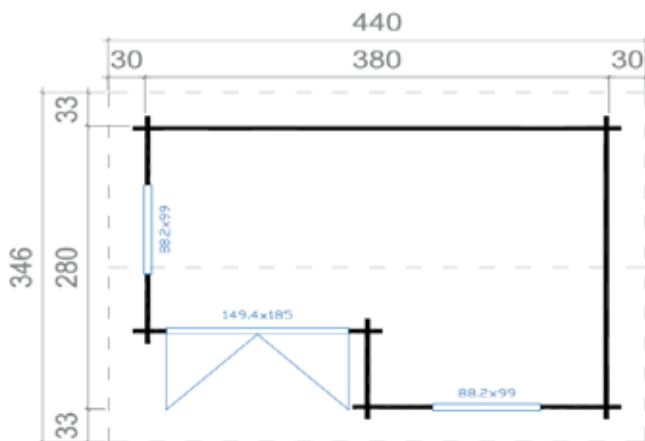

DIMENSIONS

Floor Area	8.72 m ²
Roof dimensions	4.40 x 3.46 m
Cubic volume	≈ 19.13 m ³
Wall height	≈ 2.00 m
Ridge height	≈ 2.40 m
Front overhang	≈ 33 cm

WINDOWS & DOORS (DGP+*)

1 double door	149.4 x 185.0 cm
2 single windows	88.2 x 99.0 cm
windows open inward	

PACKAGING: 1 PALLET

440 x 118 x 68 cm
969 kg



*DGP+ - Double Glazed Premium

ROOF & FLOOR

Roof/Floor boards	18 mm
Roof surface	15.84 m ²
Roof angle	≈ 16,2°
Treated Bearers	45 x 45 mm

* Optional Roof Covering available



480 x 280

BERKSHIRE 53

4414840



44 mm



2



8

★ ★ ★
GUARANTEE

5
YEARS

UNDER
2,5
metres

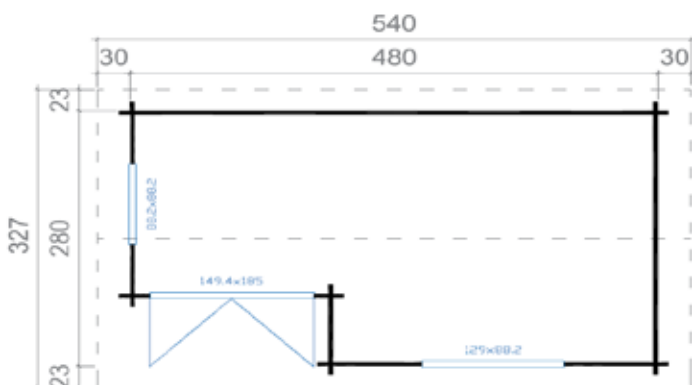

DIMENSIONS

Floor Area	11.43 m ²
Roof dimensions	5,40 x 3,27 m
Cubic volume	≈ 25,08 m ³
Wall height	≈ 2,00 m
Ridge height	≈ 2,40 m
Front overhang	≈ 23 cm

WINDOWS & DOORS (DGP+*)

1 double door	149,4 x 185,0 cm
1 single window	88,2 x 88,2 cm
1 double window	129,0 x 88,0 cm
windows open inward	

PACKAGING: 1 PALLET



630 x 118 x 58 cm
1154 kg



*DGP+ - Double Glazed Premium

ROOF & FLOOR

Roof/Floor boards	18 mm
Roof surface	19.44 m ²
Roof angle	≈ 16,2°
Treated Bearers	45 x 45 mm

* Optional Roof Covering available

BORKUM 4

407102

485 x 300



40
mm



2



9

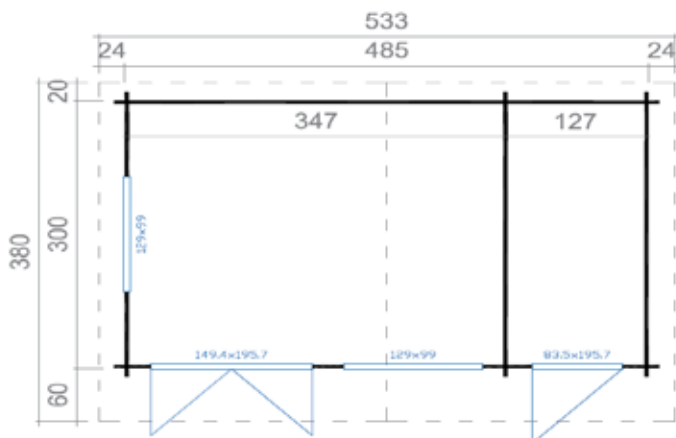

DIMENSIONS

Floor Area	13.93 m ²
Roof dimensions	5,33 x 3,80 m
Cubic volume	≈ 31,36 m ³
Wall height	≈ 2,05 m
Ridge height	≈ 2,45 m
Front overhang	≈ 60 cm

WINDOWS & DOORS (DGP+*)

1 double door	149,4 x 195,7 cm
1 single door	83,5 x 195,7 cm
2 double windows	129,0 x 99,0 cm
windows open inward	

PACKAGING: 1 PALLET



630 x 118 x 68 cm
1238 kg



*DGP+ - Double Glazed Premium Plus

ROOF & FLOOR

Roof/Floor boards	18 mm
Roof surface	20.52 m ²
Roof slope	≈ 9,4°
Treated Bearers	45 x 70 mm

* Optional Roof Covering available



300 x 300

CAPRI 44

441599



44 mm



2



7

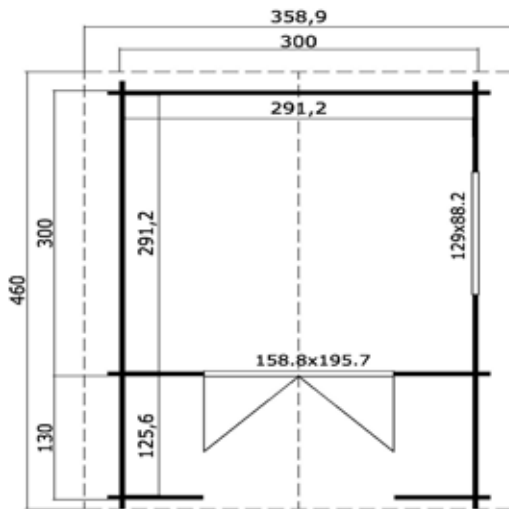

DIMENSIONS

Floor Area	8.48 m ²
Roof dimensions	3.59 x 4.60 m
Cubic volume	≈ 19.58 m ³
Wall height	≈ 2.05 m
Ridge height	≈ 2.56 m
Front overhang	≈ 140 cm

WINDOWS & DOORS (DGP+A+*)

1 double door	158.8 x 195.7 cm
1 double window	129.0 x 88.2 cm

*DGP+A+ - Single Glazed Premium+

PACKAGING: 1 PALLET



≈ 500 x 118 x 62 cm
≈ 1044 kg



ROOF & FLOOR

Roof/Floor boards	18 mm
Roof surface	17.48 m ²
Roof angle	≈ 19.2°
Treated Bearers	45 x 70 mm
Terrace boards	19 mm

* Optional Roof Covering available

CHAMELEON 44

4420002

450 x 300



☆☆☆
GUARANTEE

5
YEARS

UNDER
2,5
metres

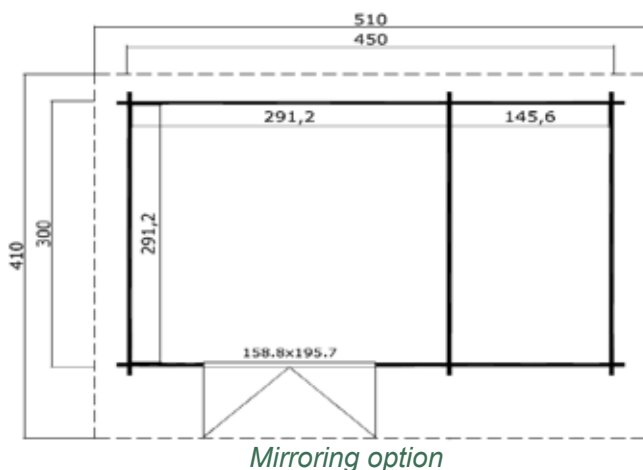

DIMENSIONS

Floor Area	12.85 m ²
Roof dimensions	5,10 x 4,10
Cubic volume	≈ 29,3 m ³
Wall height	≈ 2,22 m
Ridge height	≈ 2,34 m
Front overhang	≈ 80 cm

WINDOWS & DOORS (DGP+*)

1 double door	158,8 x 195,7 cm
1 single door	83,5 x 195,7 cm
1 single window	56,0 x 178,0 cm
windows open inward	

* single door and single window for optional positioning (cutting in required)

*DGP+ - Double Glazed Premium Plus

ROOF & FLOOR

Roof/Floor boards	18 mm
Roof surface	20.93 m ²
Roof slope	≈ 3,0°
Treated Bearers	70 x 45 mm

* *Optional Roof Covering available*

PACKAGING: 1 PALLET

630 x 118 x 69 cm





380 x 280

DEVONSHIRE 43

4413140



44 mm



2



7

☆☆☆
GUARANTEE

5
YEARS

UNDER
2,5
metres

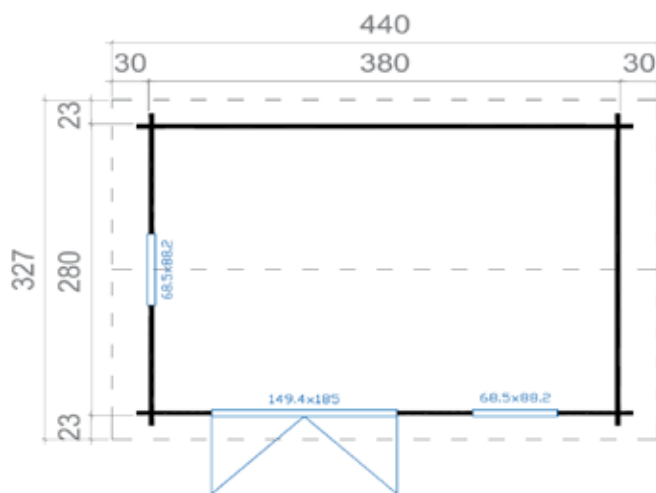

DIMENSIONS

Floor Area	10.07 m ²
Roof dimensions	4,40 x 3,27 m
Cubic volume	≈ 22,1 m ³
Wall height	≈ 2,00 m
Ridge height	≈ 2,40 m
Front overhang	≈ 23 cm

WINDOWS & DOORS (DGP+*)

1 double door	149,4 x 185,0 cm
2 single windows	68,5 x 88,2 cm
windows open inward	

PACKAGING: 1 PALLET



440 x 118 x 62 cm
910 kg



*DGP+ - Double Glazed Premium

ROOF & FLOOR

Roof/Floor boards	18 mm
Roof surface	14.96 m ²
Roof slope	≈ 16,2°
Treated Bearers	45 x 45 mm

* Optional Roof Covering available

DEVONSHIRE 54

4413240

480 x 380



 **44 mm**
 **2**
 **10**
GUARANTEE
5 YEARS
UNDER 2,5 metres

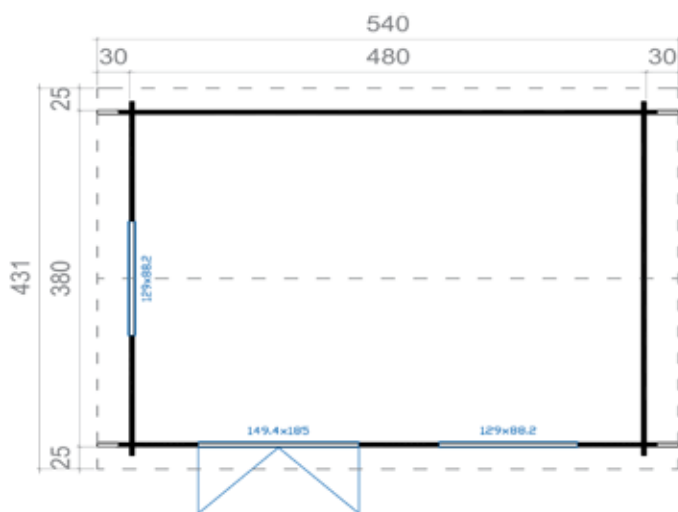

DIMENSIONS

Floor Area	17.49 m ²
Roof dimensions	5.40 x 4.31 m
Cubic volume	≈ 38.4 m ³
Wall height	≈ 2.00 m
Ridge height	≈ 2.40 m
Front overhang	≈ 25 cm

WINDOWS & DOORS (DGP+*)

1 double door	149,4 x 185,0 cm
2 double windows	129,0 x 88,2 cm
windows open inward	

*DGP+ - Double Glazed Premium

ROOF & FLOOR

Roof/Floor boards	18 mm
Roof surface	23.76 m ²
Roof slope	≈ 12°
Treated Bearers	45 x 45 mm

* *Optional Roof Covering available*

PACKAGING: 1 PALLET

	630 x 118 x 68 cm
	1305 kg





280 x 280

EDINBURGH 140

407540

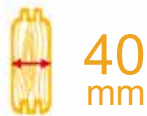

40 mm



1



6

☆☆☆
GUARANTEE

5
YEARS

UNDER
2,5
metres

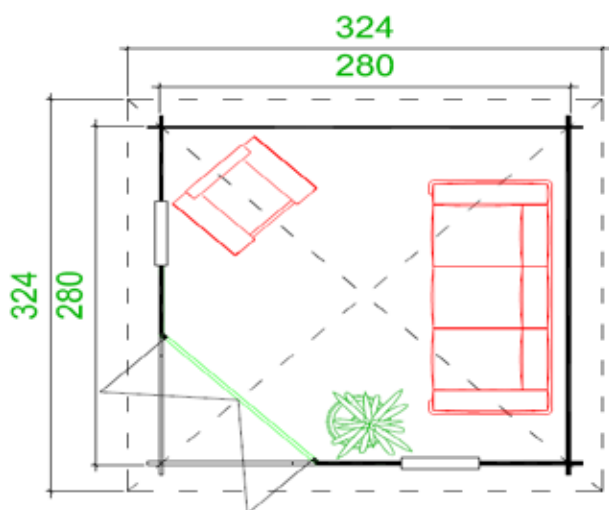

DIMENSIONS

Floor Area	6.84 m ²
Roof dimensions	3,24 x 3,24
Cubic volume	≈ 15,05 m ³
Wall height	≈ 2,05 m
Ridge height	≈ 2,46 m
Front overhang	≈ 21 cm

WINDOWS & DOORS (DGP+*)

1 double door	149,4 x 173,6 cm
2 single windows	52,5 x 156,0 cm
windows open inward	

*DGP+ - Double Glazed Premium

ROOF & FLOOR

Roof/Floor boards	18 mm
Roof surface	10.80 m ²
Roof slope	≈ 15.0°
Treated Bearers	45 x 45 mm

* Optional Roof Covering available

PACKAGING: 1 PALLET



440 x 118 x 65 cm
760 kg



EDINBURGH 240

407640

280 x 488

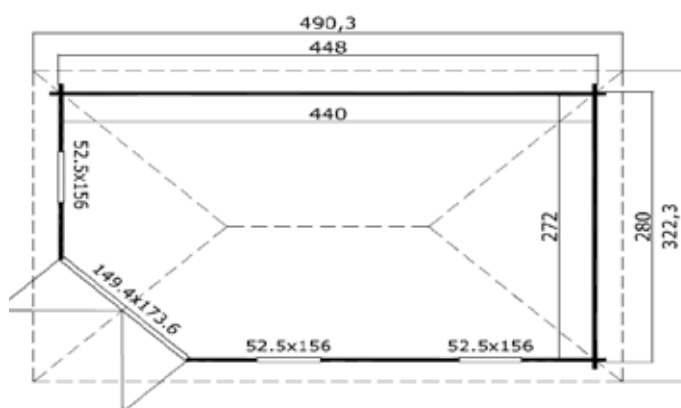

DIMENSIONS

Floor Area	11.40 m ²
Roof dimensions	3,22 x 4,90 m
Cubic volume	≈ 26,3 m ³
Wall height	≈ 2,05 m
Ridge height	≈ 2,46 m
Front overhang	≈ 21 cm

WINDOWS & DOORS (DGP+*)

1 double door	149,4 x 173,6 cm
3 single windows	52,5 x 156,0 cm
windows open inward	

PACKAGING: 1 PALLET



630 x 118 x 60 cm
985 kg



*DGP+ - Double Glazed Premium

ROOF & FLOOR

Roof/Floor boards	18 mm
Roof surface	16.35 m ²
Roof slope	≈ 15.0°
Treated Bearers	45 x 45 mm

* Optional Roof Covering available



480 x 360

ELGIN 44

4415902

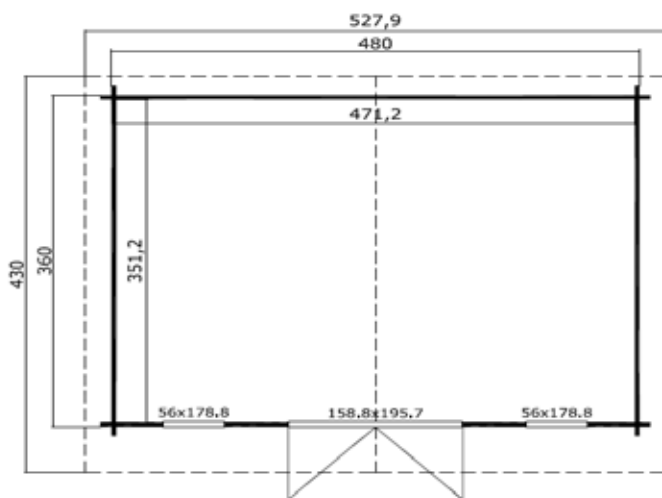

DIMENSIONS

Floor Area	16.53 m ²
Roof dimensions	5,28 x 4,30 m
Cubic volume	≈ 47,6 m ³
Wall height	≈ 2,17 m
Ridge height	≈ 2,68 m
Front overhang	≈ 50 cm

WINDOWS & DOORS (DGP+*)

1 double door	158,8 x 195,7 cm
4 single windows*	56,0 x 178,0 cm
windows open inward	
*2 windows for optional positioning	
* (cutting in required)	

*DGP+ - Double Glazed Premium

ROOF & FLOOR

Roof/Floor boards	18 mm
Roof surface	23.22 m ²
Roof angle	≈ 12,1°
Treated Bearers	45 x 45 mm

* *Optional Roof Covering available*

PACKAGING: 1 PALLET



630 x 118 x 62 cm
1200 kg



EXETER I

7012202

524 x 390



DIMENSIONS

Floor Area	18.83 m ²
Roof dimensions	6,746x4,5
Cubic volume	45,45 m ³
Wall height	≈ 2,38 m
Ridge height	≈ 2,45 m
Front overhang	≈ 120 cm

WINDOWS (2+ quality) & DOORS (2+ quality)

1 Bi-fold door	200,0 x 260,0 cm
2 single doors int.	82,7 x 193,3 cm
3 single windows	55,2 x 172,9 cm
1 single window	51,0 x 51,0 cm
1 single window	150,0 x 51,0 cm

windows are inward opening tilt and turn

ROOF & FLOOR

Roof boards	18 mm
Floor boards	28 mm
Roof surface	30.36 m ²
Roof slope	2°
Treated Bearers	70x45 mm

* Optional Roof Covering available

PACKAGING: 2 PALLETS



680x115x95 cm
2154 kg
210x115x95
665 kg





397 x 390

EXETER 2

7012302



70 mm



3



-



DIMENSIONS

Floor Area	14.94 m ²
Roof dimensions	5,478x4,5
Cubic volume	36,06 m ³
Wall height	≈ 2,38 m
Ridge height	≈ 2,45 m
Front overhang	≈ 120 cm

WINDOWS (2+ quality) & DOORS (2+ quality)

1 sliding door	200,0 x 260,0 cm
3 single windows	55,2 x 172,9 cm

windows are inward opening tilt and turn

PACKAGING: 2 PALLETS



630x115x85 cm
1786 kg
210x115x80
560 kg

ROOF & FLOOR

Roof boards	18 mm
Floor boards	28 mm
Roof surface	24.65 m ²
Roof slope	3°
Treated Bearers	70x45 mm
* Optional Roof Covering available	



INVERNESS 44

4416002

280 x 242

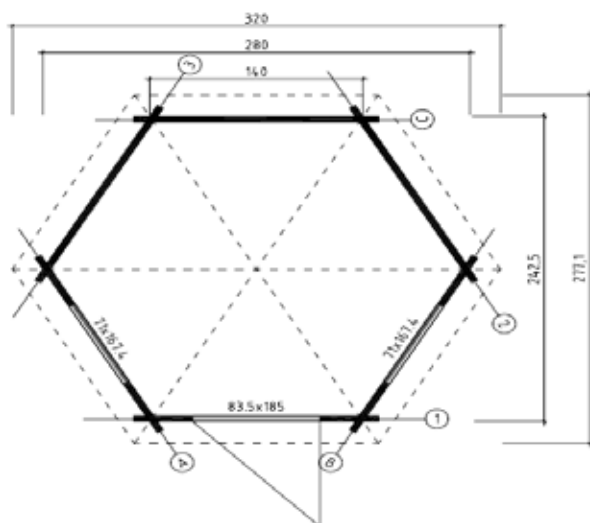

DIMENSIONS

Floor Area	4.73 m ²
Roof dimensions	3,20 x 2,77 m
Cubic volume	≈ 11,2 m ³
Wall height	≈ 2,11 m
Ridge height	≈ 2,89 m
Front overhang	≈ 17 cm

WINDOWS & DOORS (DGP+*)

1 single door	83,5 x 185,0 cm
2 single windows	71,0 x 167,4 cm
windows open inward	

PACKAGING: 1 PALLET



330 x 118 x 57 cm	539 kg
192 x 97 x 47 cm	131 kg



ROOF & FLOOR

Roof/Floor boards	18 mm
Roof surface	7.78 m ²
Roof angle	≈ 30,0°
Treated Bearers	70 x 45 mm

* Optional Roof Covering available



400 x 246

KENSINGTON

4414340



44 mm



2



7

☆☆☆
GUARANTEE

5
YEARS

UNDER
2,5
metres

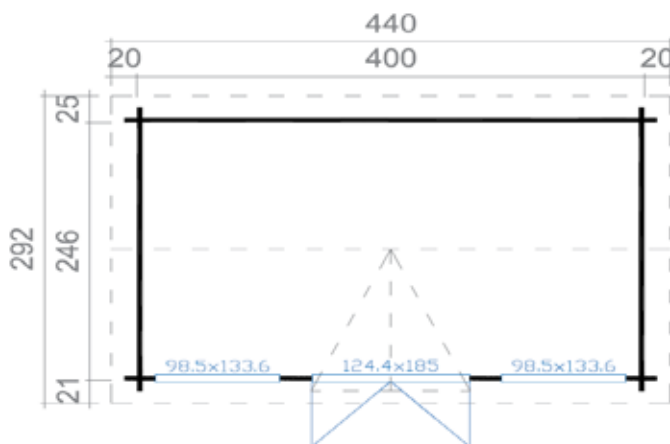

DIMENSIONS

Floor Area	9.44 m ²
Roof dimensions	4,40 x 2,92 m
Cubic volume	≈ 20,71 m ³
Wall height	≈ 2,00 m
Ridge height	≈ 2,40 m
Front overhang	≈ 21 cm

WINDOWS & DOORS (DGP+*)

1 double door	124,4 x 185,0 cm
2 double windows	98,5 x 133,6 cm

windows open inward

PACKAGING: 1 PALLET



440 x 118 x 65 cm
927 kg



*DGP+ - Double Glazed Premium

ROOF & FLOOR

Roof/Floor boards	18 mm
Roof surface	14.24 m ²
Roof angle	≈ 13,0°/24,4°
Treated Bearers	70 x 45 mm

* Optional Roof Covering available

MAURITIUS 44

446794

330 x 510



44 mm



2



9

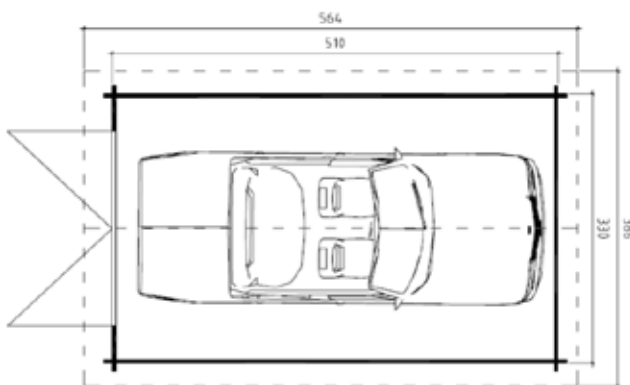

DIMENSIONS

Floor Area	16,10 m ²
Roof dimensions	3,86 x 5,64 m
Cubic volume	≈ 38,08 m ³
Wall height	≈ 2,11 m
Ridge height	≈ 2,62 m
Front overhang	≈ 30 cm

WINDOWS & DOORS

1 garage door	239,0 x 202,0 cm
---------------	------------------

PACKAGING: 1 PALLET



630 x 118 x 54 cm
1086 kg



ROOF & FLOOR

Roof/Floor boards	18 mm
Roof surface	22,40 m ²
Roof slope	≈ 17,5°
Treated Bearers	45 x 70 mm

* Optional Roof Covering available



350 x 350

NEWBURY

4421402



44 mm



3



10

☆☆☆
GUARANTEE

5
YEARS

UNDER
2,5
metres

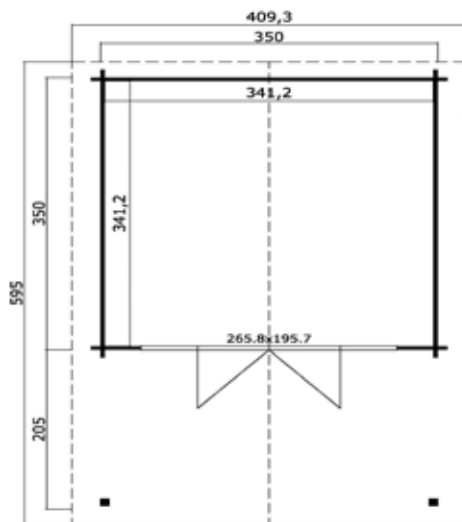

DIMENSIONS

Floor Area	11.64 m ²
Roof dimensions	4.09 x 5.95 m
Cubic volume	≈ 26.21 m ³
Wall height	≈ 2.05 m
Ridge height	≈ 2.45 m
Front overhang	≈ 225 cm

WINDOWS & DOORS (DGP+*)

1 double door	265.8 x 195.7 cm
1 single window	52.5 x 167.4 cm

window open inward

*DGP+ - Double Glazed Premium

ROOF & FLOOR

Roof/Floor boards	18 mm
Roof surface	24.99 m ²
Roof angle	≈ 13°
Treated Bearers	45 x 45 mm

* Optional Roof Covering available

PACKAGING: 1 PALLET



630 x 118 x 67,5 cm
1238 kg.



OBAN 40

408940

240 x 240



40 mm



1



5



5 YEARS

UNDER 2,5 metres

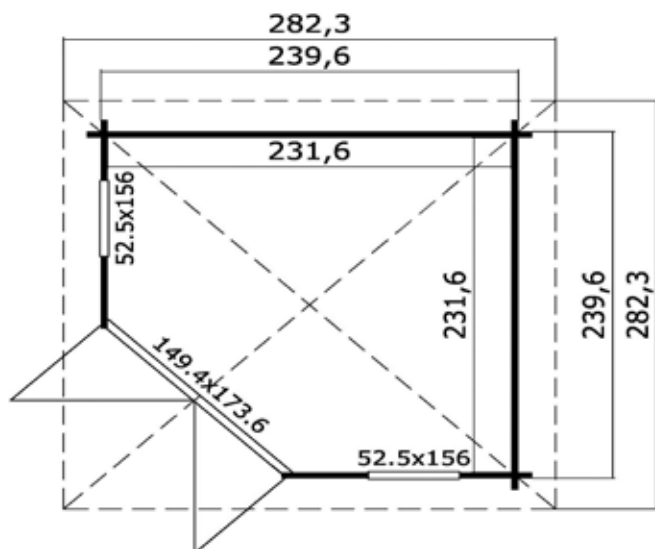

DIMENSIONS

Floor Area	4,81
Roof dimensions	2,82 x 2,82 m
Cubic volume	≈ 10,5 m ³
Wall height	≈ 2,05 m
Ridge height	≈ 2,41 m
Front overhang	≈ 21,3 cm

WINDOWS & DOORS (DGP+*)

1 double door	149,4 x 173,6 cm
2 single windows	52,5 x 156,0 cm
windows open inward	

*DGP+ - Double Glazed Premium

PACKAGING: 1 PALLET



≈ 330 x 118 x 69 cm
≈ 623 kg



ROOF & FLOOR

Roof/Floor boards	18 mm
Roof surface	8.25 m ²
Roof slope	≈ 15.0°
Treated Bearers	45 x 45 mm

* Optional Roof Covering available



480 x 280

OXFORDSHIRE 53

4414002



44 mm



2



9

★ ★ ★
GUARANTEE

5
YEARS

UNDER
2,5
metres

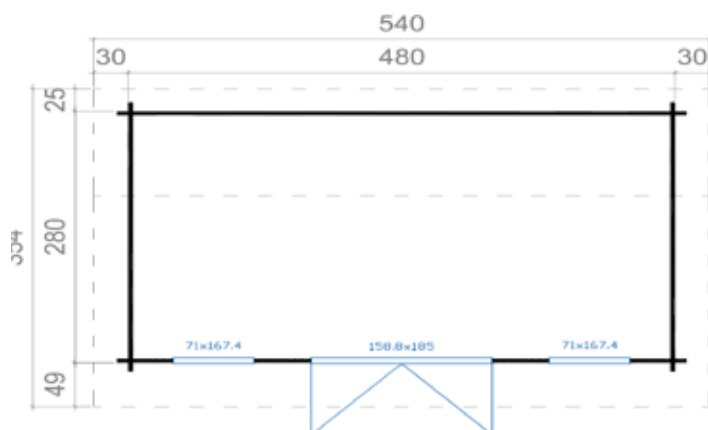

DIMENSIONS

Floor Area	12.78 m ²
Roof dimensions	5,40 x 3,54 m
Cubic volume	≈ 28,1 m ³
Wall height	≈ 2,00 m
Ridge height	≈ 2,40 m
Front overhang	≈ 49 cm

WINDOWS & DOORS (DGP+*)

1 double door	158,8 x 185,0 cm
2 single windows	71,0 x 167,4 cm
windows open inward	

PACKAGING: 1 PALLET



630 x 118 x 55 cm
1090 kg



*DGP+ - Double Glazed Premium

ROOF & FLOOR

Roof/Floor boards	18 mm
Roof surface	19.98 m ²
Roof angle	≈ 23,7° / 12,2°
Treated Bearers	45 x 45 mm

* Optional Roof Covering available

PEMBROKESHIRE 53

4414740

480 x 280

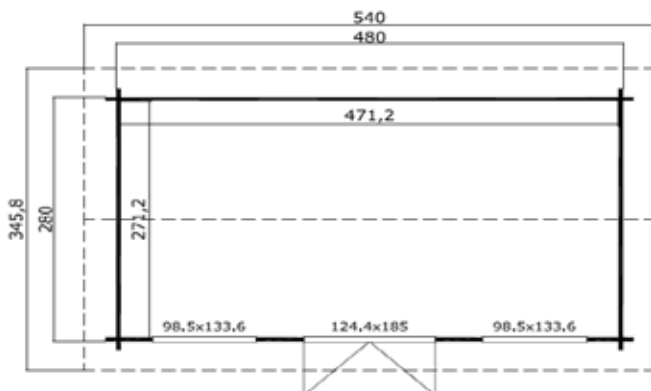

DIMENSIONS

Floor Area	12.80 m ²
Roof dimensions	5,40 x 3,46 m
Cubic volume	≈ 28,1 m ³
Wall height	≈ 2,00 m
Ridge height	≈ 2,40 m
Front overhang	≈ 33 cm

WINDOWS & DOORS (DGP+*)

1 double door	124,4 x 185,0 cm
2 double windows	98,5 x 133,6 cm
windows open inward	

PACKAGING: 1 PALLET



630 x 118 x 55 cm
1078 kg



*DGP+ - Double Glazed Premium

ROOF & FLOOR

Roof/Floor boards	18 mm
Roof surface	19.44 m ²
Roof angle	≈ 16,2°
Treated Bearers	45 x 45 mm

* Optional Roof Covering available



400 x 400

PORTSMOUTH 44

4420102



44 mm



2



8

★ ★ ★
GUARANTEE

5
YEARS

UNDER
2,5
metres

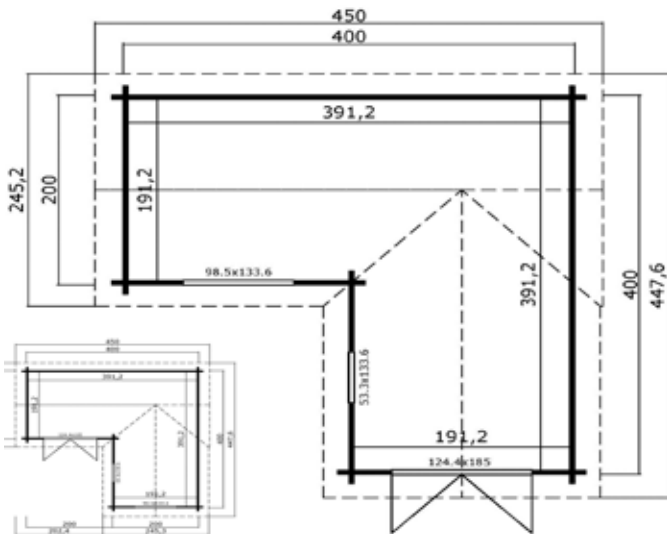

PACKAGING: 1 PALLET



630 x 118 x 63.5 cm
1265 kg



DIMENSIONS

Floor Area	11.30 m ²
Roof dimensions	4.5 x 4.48 m
Cubic volume	≈ 25.76 m ³
Wall height	≈ 2.11 m
Ridge height	≈ 2.45 m
Front overhang	≈ 25 cm

WINDOWS & DOORS (DGP+A+*)

1 double door	124.4 x 185.0 cm
1 single window	53.3 x 133.6 cm
1 double window	98.5 x 133.6 cm
windows open inward	

*DGP+A+ - Double Glazed Premium

ROOF & FLOOR

Roof/Floor boards	18 mm
Roof surface	17.52 m ²
Roof angle	≈ 19.4°
Treated Bearers	70 x 45 mm

- * Optional Roof Covering available
- * Valley Underlay for Covering available
- * Valley detail strips would be required.

RIVIERA 44

4416802

350 x 303



44
mm



2



8

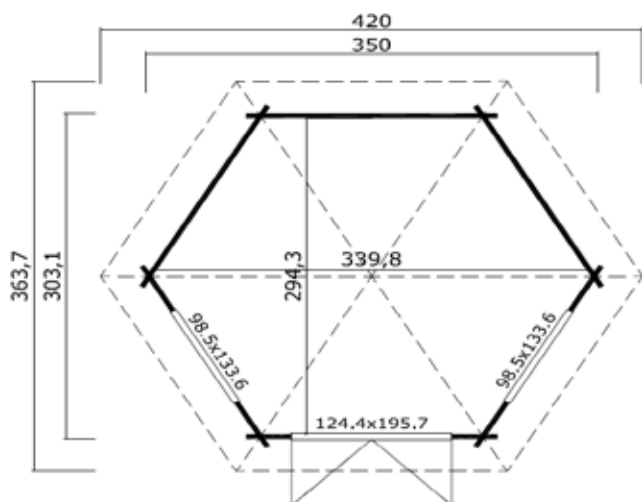

DIMENSIONS

Floor Area	7.50 m ²
Roof dimensions	4,20 x 3,64 m
Cubic volume	≈ 20,1 m ³
Wall height	≈ 2,28 m
Ridge height	≈ 3,18 m
Front overhang	≈ 30 cm

WINDOWS & DOORS (DGP+*)

1 double door	122,4 x 195,7 cm
2 double windows	98,5 x 133,6 cm
windows open inward	

*DGP+ - Double Glazed Premium

ROOF & FLOOR

Roof/Floor boards	18 mm
Roof surface	13.23 m ²
Roof angle	≈ 30,0°
Treated Bearers	70 x 45 mm

* Optional Roof Covering available

PACKAGING: 1 PALLET



330 x 118 x 95 cm
826 kg





480 x 280

WARWICKSHIRE 53

4413040



44 mm



2



9

★ ★ ★
GUARANTEE

5

YEARS

UNDER
2,5
metres

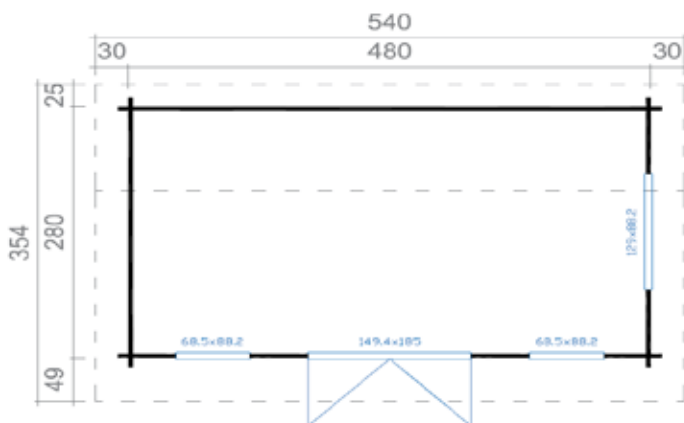

DIMENSIONS

Floor Area	12.78 m ²
Roof dimensions	5,40 x 3,54 m
Cubic volume	≈ 28,1 m ³
Wall height	≈ 2,00 m
Ridge height	≈ 2,40 m
Front overhang	≈ 49 cm

WINDOWS & DOORS (DGP+*)

1 double door	149,4 x 185,0 cm
2 single windows	68,5 x 88,2 cm
1 double window	129,0 x 88,2 cm

windows open inward

*DGP+ - Double Glazed Premium

ROOF & FLOOR

Roof/Floor boards	18 mm
Roof surface	19.98 m ²
Roof angle	≈ 23,7°/12,2°
Treated Bearers	45 x 45 mm

* Optional Roof Covering available

PACKAGING: 1 PALLET



630 x 118 x 58 cm
1120 kg



WINDSOR MINI

4421102

250 x 300

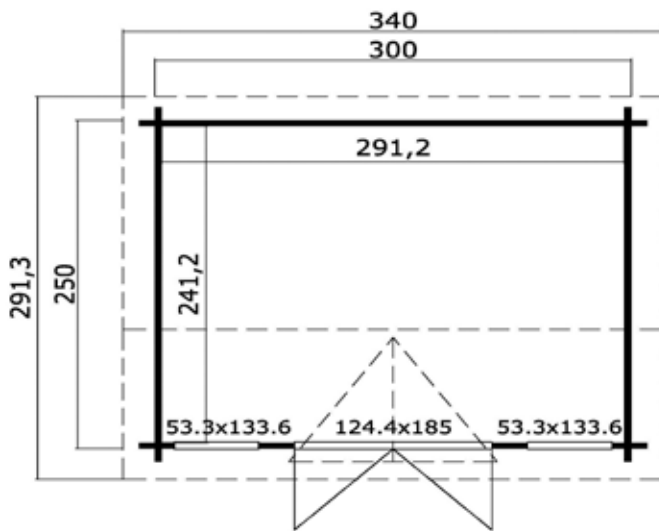

DIMENSIONS

Floor Area	7.02 m ²
Roof dimensions	2.91 x 3.40 m
Cubic volume	≈ 15.8 m ³
Wall height	≈ 2.11 m
Ridge height	≈ 2.40 m
Front overhang	≈ 23 cm

WINDOWS & DOORS (DGP+A+*)

1 double door	124.4 x 185.0 cm
2 single windows	53.3 x 133.6 cm
windows open inward	

*DGP+ - Double Glazed Premium Plus.

ROOF & FLOOR

Roof/Floor boards	18 mm
Roof surface	11.02 m ²
Roof slope	≈ 10.2°/17.9°/24.6°
Treated Bearers	70x45 / 45x45 mm

* Optional Roof Covering available

PACKAGING: 1 PALLET



440 x 118 x 65 cm
771 kg.





300 x 400

WINDSOR 44

4415240



44 mm



2



8

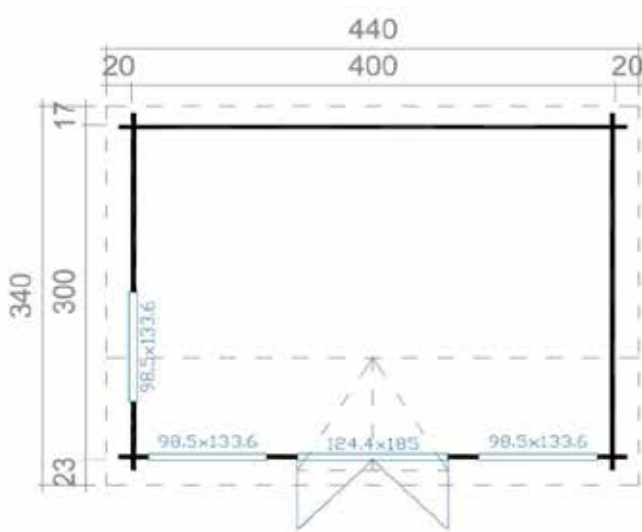

DIMENSIONS

Floor Area	11,40 m ²
Roof dimensions	3,40 x 4,40 m
Cubic volume	≈ 25,7 m ³
Wall height	≈ 2,11 m
Ridge height	≈ 2,40 m
Front overhang	≈ 24 cm

WINDOWS & DOORS (DGP+*)

1 double door	124,4 x 185,0 cm
3 double windows	98,5 x 133,6 cm

windows open inward

*DGP+ - Double Glazed Premium

PACKAGING: 1 PALLET



440 x 118 x 70 cm
992 kg



ROOF & FLOOR

Roof/Floor boards	18 mm
Roof surface	16,30 m ²
Roof slope	≈ 10,8/17,7°24,6°
Treated Bearers	70x45 / 45x45 mm

* Optional Roof Covering available

WREXHAM I

4416602

390 x 240



5
YEARS

UNDER
2,5
metres

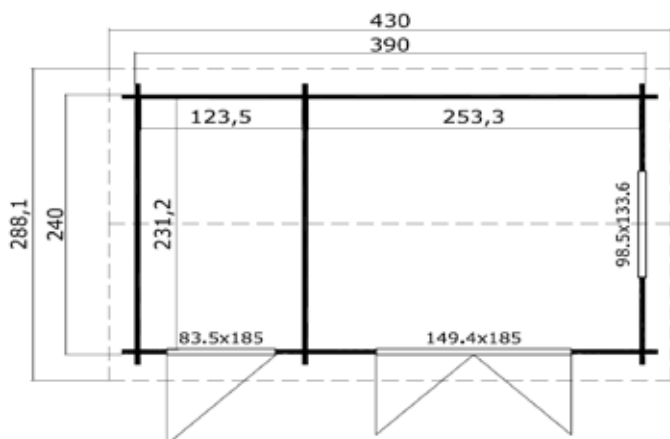

DIMENSIONS

Floor Area	8.81 m ²
Roof dimensions	4,30 x 2,88 m
Cubic volume	≈ 20,09 m ³
Wall height	≈ 2,11 m
Ridge height	≈ 2,45 m
Front overhang	≈ 24 cm

WINDOWS & DOORS (DGP+*)

1 double door	149,4 x 185,0 cm
1 single door	83,5 x 185,0 cm
1 double window	98,5 x 133,6 cm
windows open inward	

*DGP+ - Double Glazed Premium

ROOF & FLOOR

Roof/Floor boards	18 mm
Roof surface	12.90 m ²
Roof angle	≈ 16,2°
Treated Bearers	70 x 45 mm

* Optional Roof Covering available

PACKAGING: 1 PALLET



440 x 118 x 69 cm
920 kg

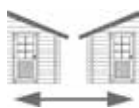



485 x 300

WREXHAM 2

4416740



44 mm



2



8

★ ★ ★
GUARANTEE

5
YEARS

UNDER
2,5
metres

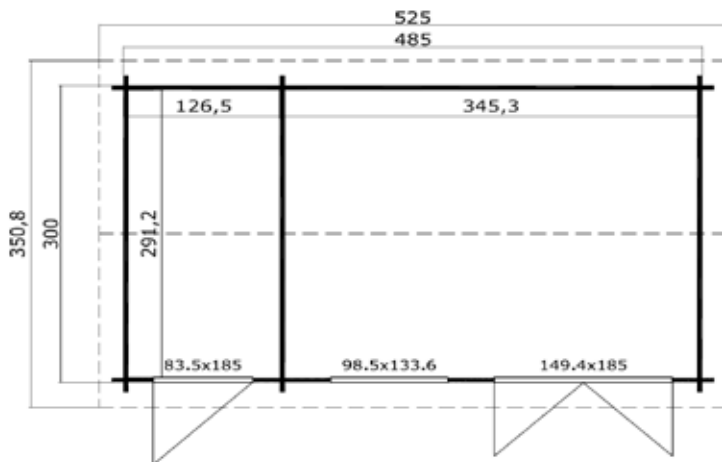

DIMENSIONS

Floor Area	13.87 m ²
Roof dimensions	5,25 x 3,51 m
Cubic volume	≈ 31,62 m ³
Wall height	≈ 2,11 m
Ridge height	≈ 2,45 m
Front overhang	≈ 25 cm

WINDOWS & DOORS (DGP+*)

1 double door	149,4 x 185,0 cm
1 single door	83,5 x 185,0 cm
a single window	98,5 x 133,6 cm
windows open inward	

*DGP+ - Double Glazed Premium Plus.

ROOF & FLOOR

Roof/Floor boards	18 mm
Roof surface	18.90 m ²
Roof angle	≈ 13,0°
Treated Bearers	45 x 70 mm

* *Optional Roof Covering available*

PACKAGING: 1 PALLET



630 x 118 x 68 cm
1238 kg



BIKE SHELTERS 2000

288700

150 x 200

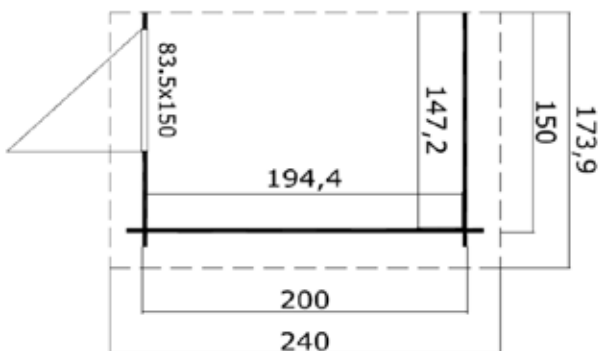

DIMENSIONS

Floor Area	2,81 m ²
Roof dimensions	1,74 x 2,40 m
Cubic volume	≈ 4,72m ³
Wall height	≈ 1,48m
Ridge height	≈ 1,88 m
Front overhang	≈ 24 cm

WINDOWS & DOORS (TC*)

1 single door	83,5 x 150,0 cm
door open outward	

PACKAGING: 1 PALLET



440 x 118 x 31 cm
300 kg



*TC - Classic

ROOF & FLOOR

Roof/Floor boards	18 mm
Roof surface	4,32 m ²
Roof slope	≈ 14,9°
Treated Bearers	70 x 45 mm

* Optional Roof Covering available



150 x 260

BIKE SHELTERS 2600

288600



28 mm



1



3

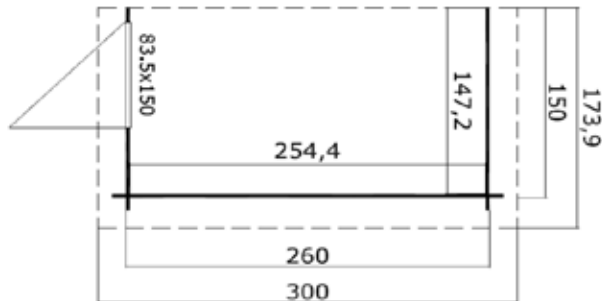

DIMENSIONS

Floor Area	3,67 m ²
Roof dimensions	1,74 x 3,00 m
Cubic volume	≈ 6,18m ³
Wall height	≈ 1,48m
Ridge height	≈ 1,88 m
Front overhang	≈ 20 cm

WINDOWS & DOORS (TC*)

1 single door	83,5 x 150,0 cm
door open outward	

PACKAGING: 1 PALLET



440 x 118 x 33 cm
330 kg



*TC - Classic

ROOF & FLOOR

Roof/Floor boards	18 mm
Roof surface	5,40 m ²
Roof slope	≈ 14,9°
Treated Bearers	70 x 45 mm

* Optional Roof Covering available

BIKE EXTENSION 2000

2829200

200 x 120

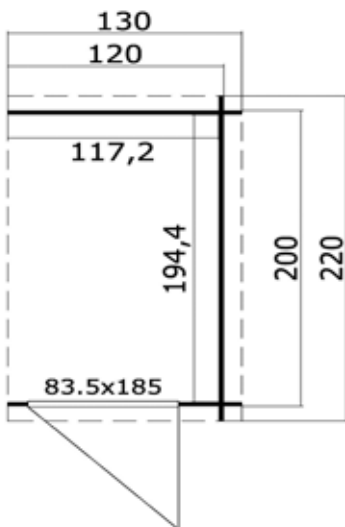

DIMENSIONS

Floor Area	2.22 m ²
Roof dimensions	1.30 x 2.20 m
Cubic volume	≈ 4.44 m ³
Wall height	≈ 1.88 m
Ridge height	≈ 2.11 m
Front overhang	≈ 10 cm

WINDOWS & DOORS (TC+O*)

1 single door	83.5 x 185.0 cm
---------------	-----------------

PACKAGING: 1 PALLET



≈ 440 x 118 x 31 cm
≈ 300 kg



*TC+O - Classic

ROOF & FLOOR

Roof/Floor boards	18 mm
Roof surface	2.88 m ²
Roof slope	≈ 6.6°
Treated Bearers	45 x 70 mm

* Optional Roof Covering available



260 x 140

BIKE EXTENSION 2600

2829600



28 mm



1

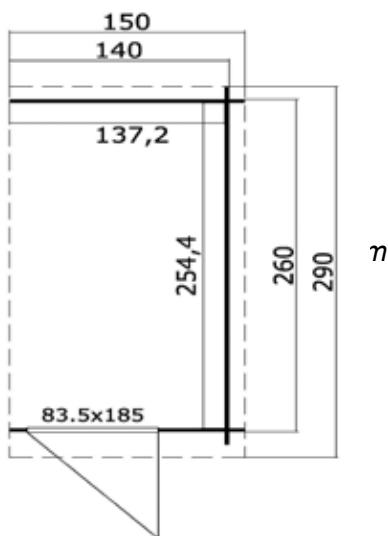

DIMENSIONS

Floor Area	3.42 m ²
Roof dimensions	1.50 x 2.90 m
Cubic volume	≈ 6.82 m ³
Wall height	≈ 1.88 m
Ridge height	≈ 2.11 m
Front overhang	≈ 20 cm

WINDOWS & DOORS (TC+O*)

1 single door	83.5 x 185.0 cm
---------------	-----------------

PACKAGING: 1 PALLET



≈ 440 x 118 x 31 cm
≈ 300 kg



*TC+O - Classic

ROOF & FLOOR

Roof/Floor boards	18 mm
Roof surface	4.37 m ²
Roof slope	≈ 5.1°
Treated Bearers	45 x 70 mm

* Optional Roof Covering available



◀ THE BAR
PAGE 90



◀ EPDM
PAGE 93



◀ SOLAR KIT
PAGE 95

ACCESSORIES



BERKSHIRE ▶
LOUVRE
PAGE 91



FELT ▶
PAGE 93



◀ HANDLE
UPGRADES
PAGE 92



◀ SHINGLES
PAGE 94

THE BAR

991900

190 x 65



ADDING FINISHING TOUCHES

We like to think we listen to our customers, and an example is the introduction this year of “The Bar”.

Our cabins are used for multiple purposes and a “man cave” is one of them, or just purely to entertain

friends and family, this neat bar, can be added to almost any sized cabin, and is easy to install, if shelves are

Required we can even send some additional logs to adapt it.



172.5 x 63

BERKSHIRE LOUVRE

4417040



ADDED FEATURES

The Berkshire is one of our most popular cabins but to shelter the porch we added an additional option of a side louvre.



HINGE COVERS

NEW FOR 2017

We are also now introducing hinge covers to provide additional protection to the hinges.

UPGRADE HANDLES

PREFER BETTER WINDOW AND LOCKING DOOR HANDLES?

As an option some customers demand only the best, so we now can send out sets of lockable window handles as an added option for more security, and higher grade door handles for a even better finish.

All our cabins come with either a two or five year warranty, but the cabins will outlive most of us as long as they are treated with wood preserver every couple of years.

DOOR

Lock, Cylinder, Handle & Plate

WINDOW

Locking window handle



FELT

We supply our cabins without roof covering, as we believe choice is what our customers are looking for. We offer options of felt in one colour, shingles in four colours and now Firestone EPDM.

CODE: RFE



EPDM

Our Firestone RubberGard EPDM LSFR (Low Slope Fire Retardant Roofing Membrane) is one of the best and well known in the industry comes with a 30 year guarantee but will last 50 years.

Can be applied to both Pent and flat roof cabins, our kit comes with the glue and sufficient material to cover your cabin. Contact us for fitting instructions.

EPDM GLUE (1 LITRE)

1 litre BossCover Spraybond Flexible EPDM glue. The most frequently used, and is a unique elastic EPDM-based adhesive with modified polymers, can be used on one surface only, and is correctable for half an hour.



SHINGLES

SHB (BLACK) - SHBR (BROWN) - SHG (GREEN) - SHR (RED)

Our Bitumen Shingles are manufactured by Shinglas / Mida, and conform to EN 544, are high quality mineral and synthetic reinforcement. We recommend use on roof pitches no less than 12 Degrees.

The Bitumionous shingle is the Rock Trio S Classic and our warranty period for shingles is 10 years. Thickness is $\geq 3,0$



Black



Brown

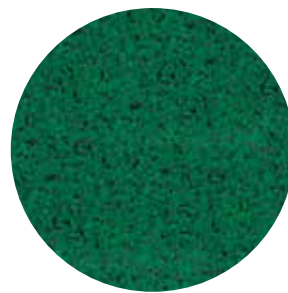

Green



Red

Black Shingles
in position >



SOLAR KIT

SP

Our solar panel kit, comes with everything you need to add some light into your cabin. it comes with:

1 x Small solar panel (15v 7W) 360 x 180 x 18.3

3 x 12V 3W LED bulbs

1 x Lamp switch

3 x Metres DC Line

1 x Power bank with 2 USB sockets to charge your phones or other accessories.

Full set of instructions for easy installation

Note: You will need to purchase a 2 to 3 pin plug adapter, should you wish to use the DC power supply.





cabins
unlimited