

Alex Mini
Art. Nr. 4416540
1/8

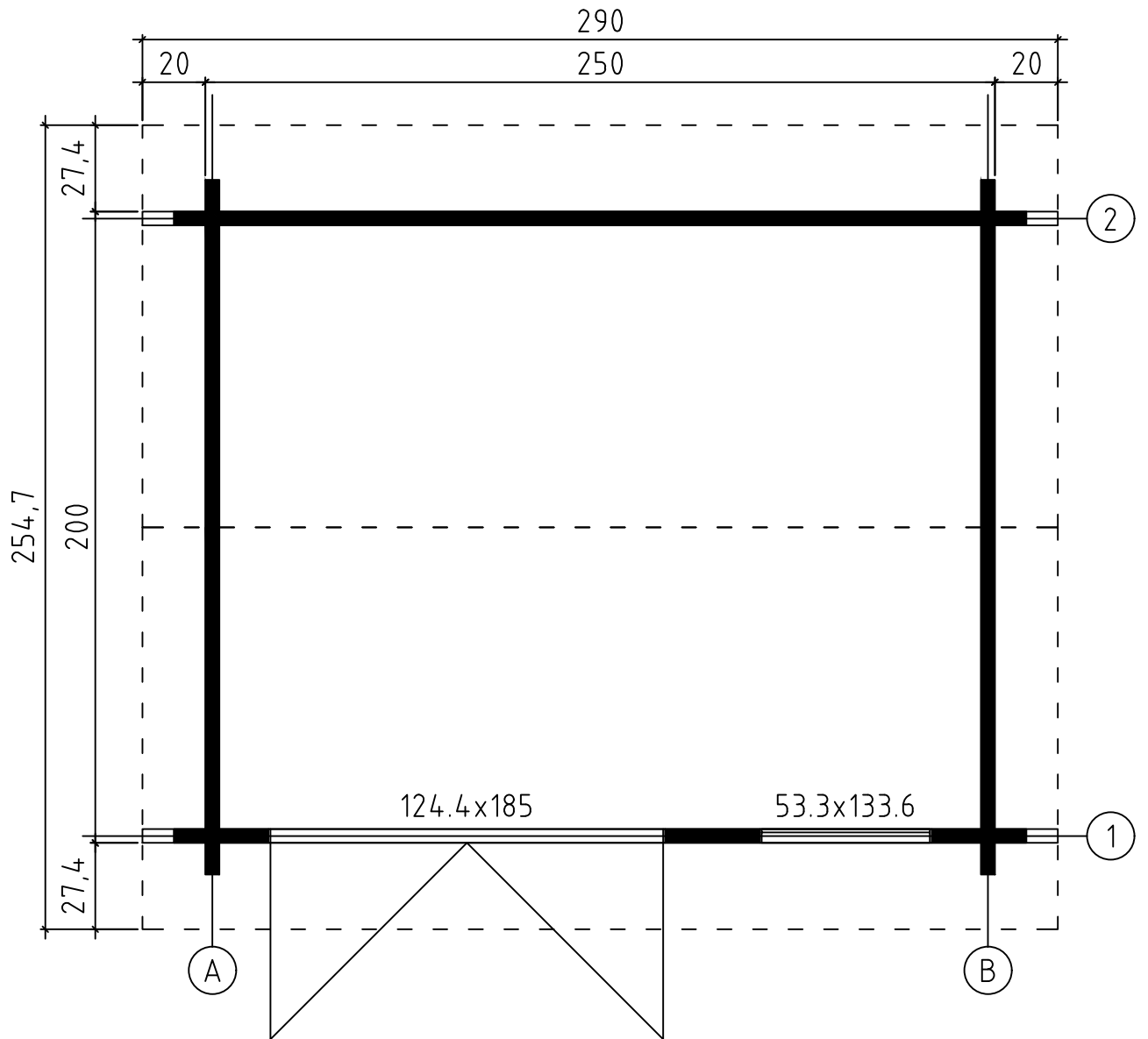

17.06.2016

GROUNDPLAN - GRUNDPLAN - PLAN DE MASSE



Art. Nr. 4416540

FOUNDATION - FUNDAMENT - FONDATION

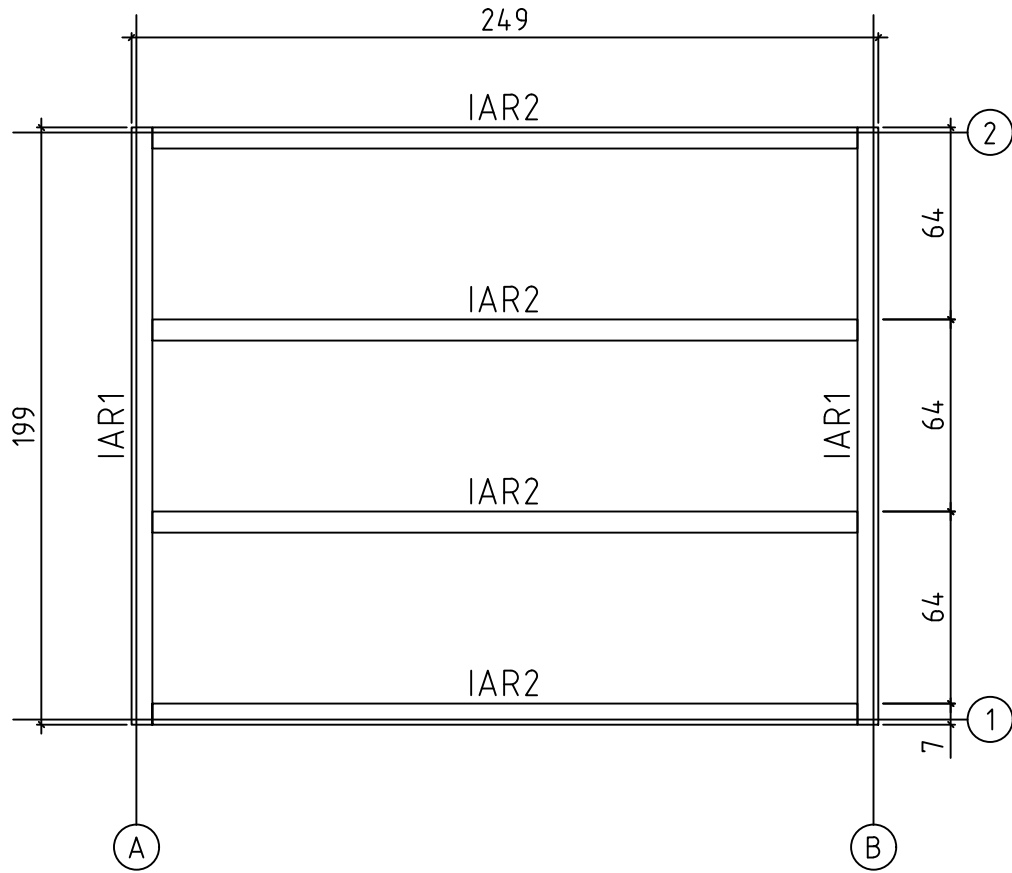

FLOOR BOARDS - FUSSBODENBRETTER - PLAN POSE PLANCHER

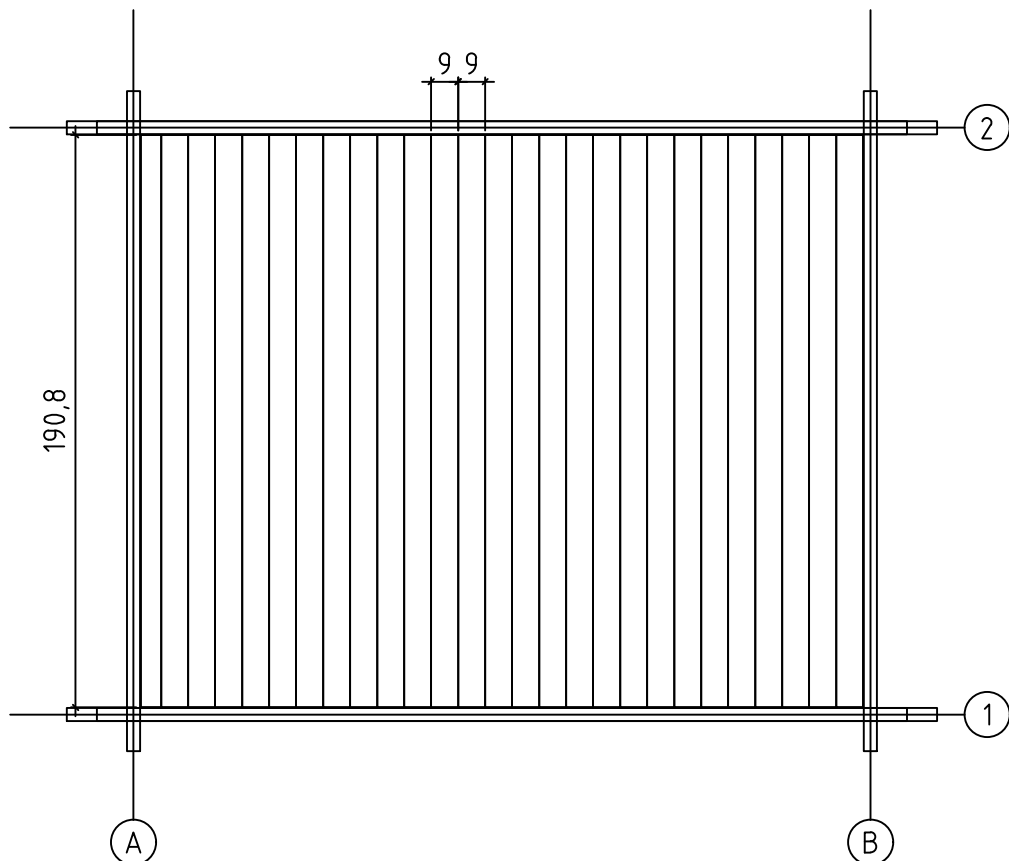



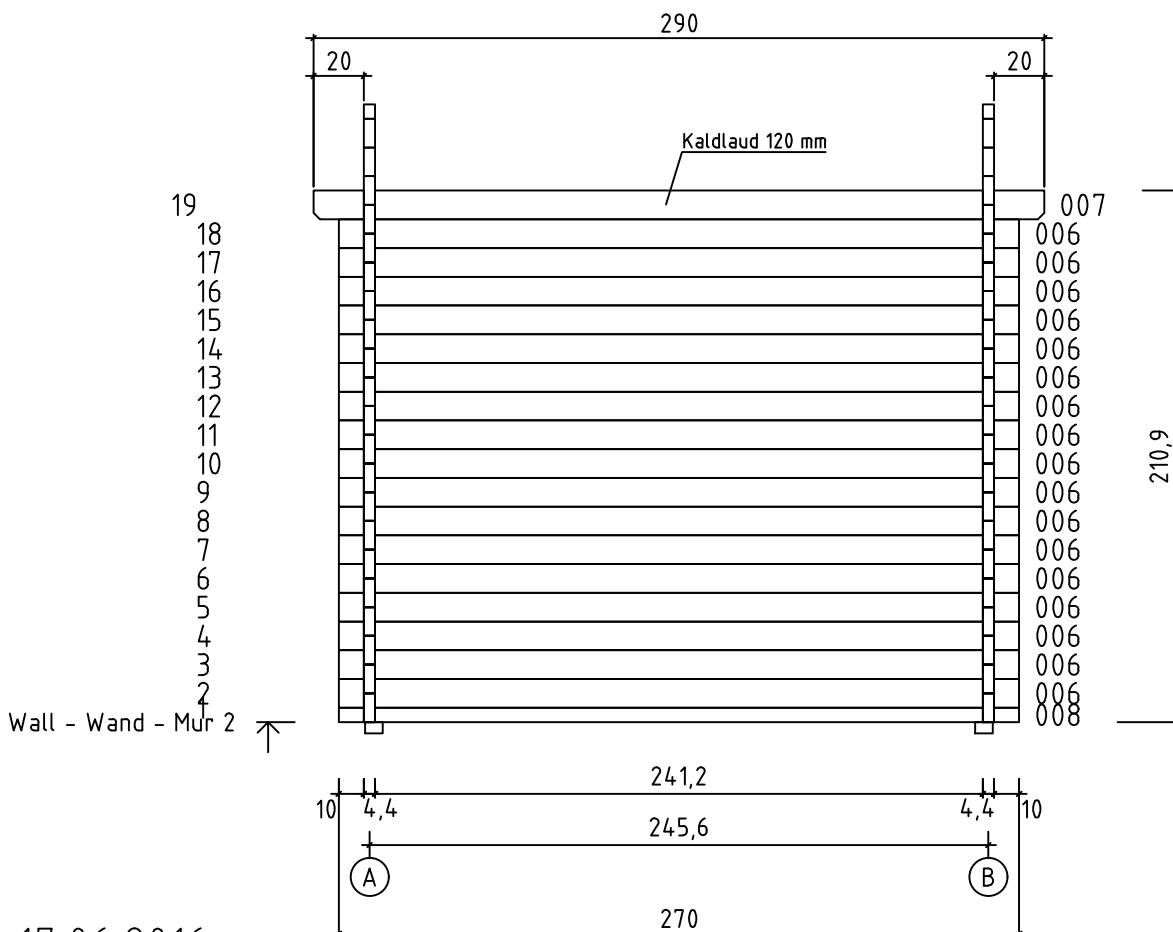
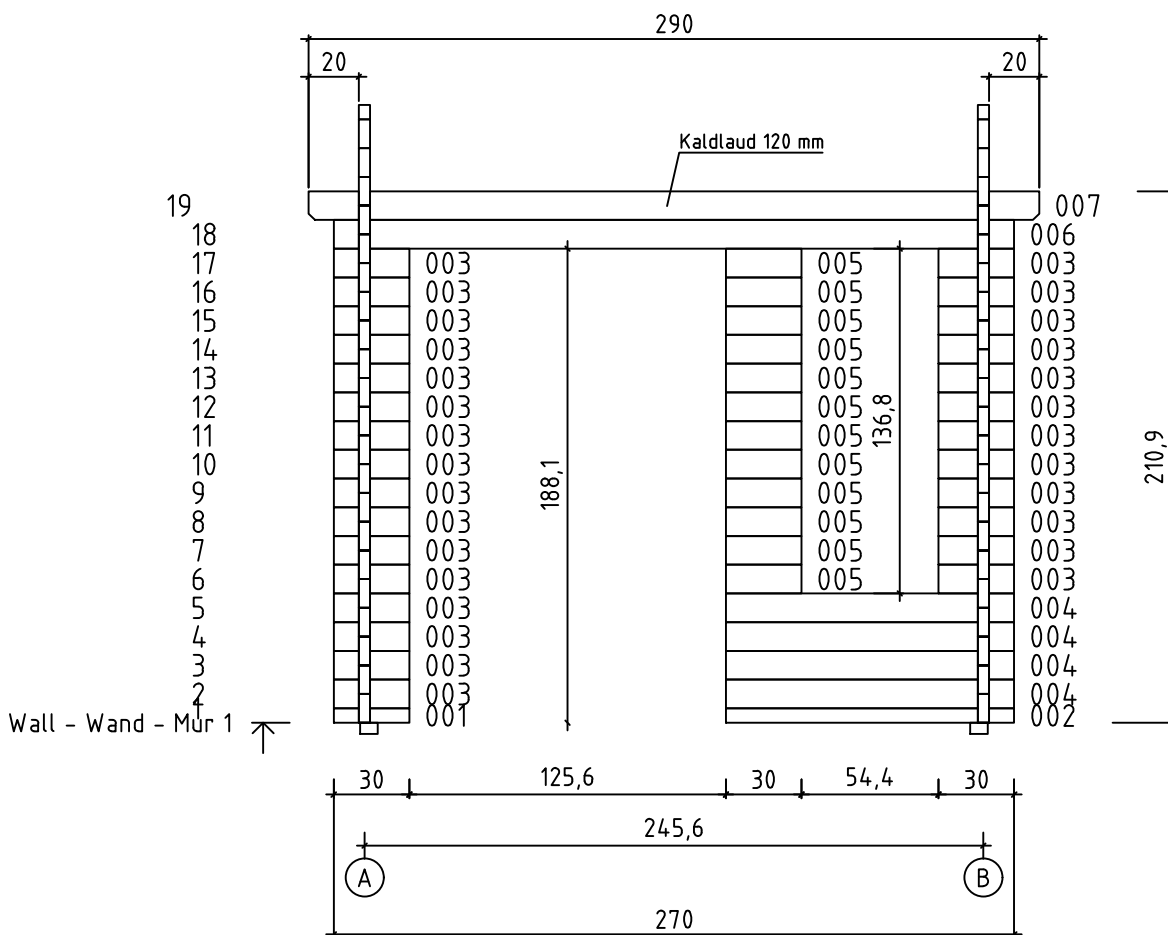



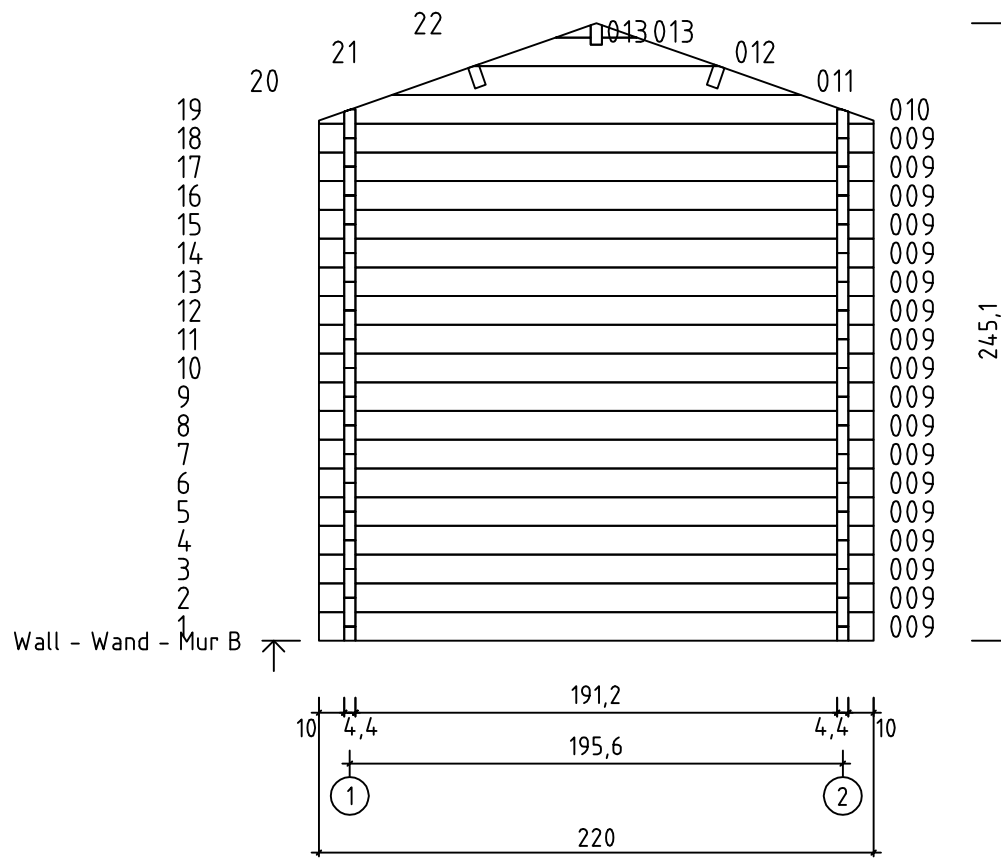
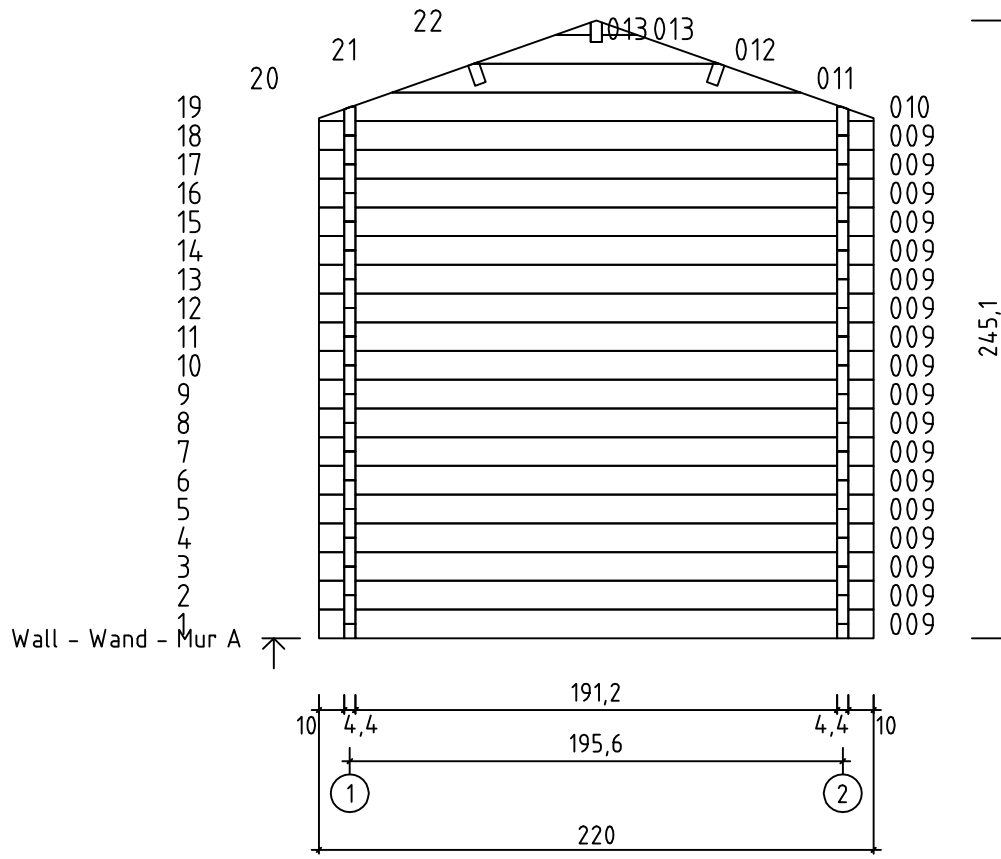

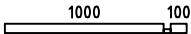

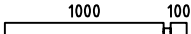

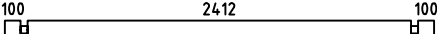
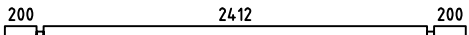
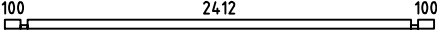
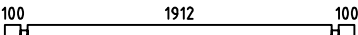
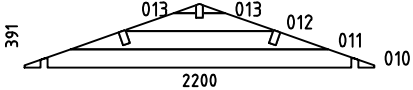

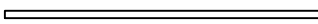
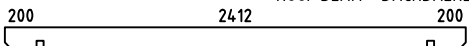
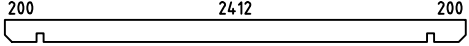



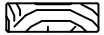
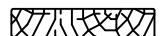

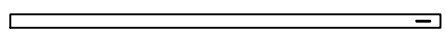
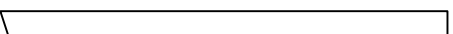
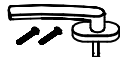



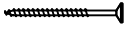
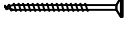
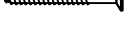

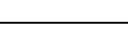
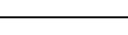
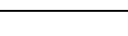
Art. Nr. 4416540

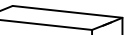

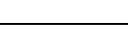
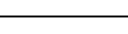
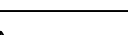
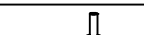
Art. Nr. 4416540



Pos	17.06.2016	Piecelist - Stücklist - Liste des composants Art. Nr. 4416540	6/8	Q.	P. (mm)	L. (mm)
001				1	44x57	300
002				1	44x57	1144
003				28	44x114	300
004				4	44x114	1144
005				12	44x114	300
006				18	44x114	2700
007				2	44x120	2900
008				1	44x57	2700
009				36	44x114	2200
WA-1 WB-1				1 1		
IAR2		FOUNDATION - FUNDAMENT - FONDATION		4	70x45	2350
IAR1		FOUNDATION - FUNDAMENT - FONDATION		2	70x45	1990
PR1		ROOF BEAM - DACHBALKEN - PANNE DE TOIT		1	44x140	2900
A-PR1		ROOF BEAM - DACHBALKEN - PANNE DE TOIT		2	44x140	2900
	FLOOR BOARDS - FUSSBODENBRETTER - LAME DE PLANCHER			27	90x18	1908
	ROOF BOARDS - DACHBRETTER - VOLIGES			66	90x18	1350
	FLOOR FILLET - FUSSBODENLEISTE - CORNIERE DE FINITION DU PLANCHER				18x18	8.63
	ROOFING FELT FILLET - DACHPAPPENLEISTE - BAGUETTE DE FIXATION DU FEUTRE BITUMEUX			4	18x58	1400
TB-1	EAVES BOARD - TRAUFBRETT - BANDEAU DE TOIT			2	18x90	2900
DRV-1	ROOF EDGE REINFORCEMENT - DACHRANDVERSTÄRKUNG - CORNIERE DE RENFORT DE BORD DE TOIT			2	28x34	2900
KFS-1	STORM PROTECTION - STURMLEISTE - - LATTE ANTI-TEMPETE			4	22x45	2050
	GABLE MOULDING - GIEBELLEISTE - - PLANCHE DE RIVE			4	18x120	1400
FS2	WINDOW HANDLE FITTINGS - FENSTERGRIFF - POIGNÉE D'OUVERTURE DE FENETRE			1	FG10.AL	
HS1	SCREW FOR GEORGIAN BARS - SCHRAUBE FÜR SPROSSEN - VIS DE BARRES GEORGIANNE			28	2.5x20	

Pos	17.06.2016	Piecelist - Stücklist - Liste des composants Art. Nr. 4416540	7/8	Q.	P. (mm)	L. (mm)
HS8	SCREW FOR GABLE SEGMENT - SCHRAUBEN FÜR DECKBLATT - VIS POUR FIXATION LOSANGE DE FINITION		4	3.5x35		
HS9	SCREW FOR GABLE MOULDING - SCHRAUBEN FÜR GIEBELLEISTE - VIS DE FIXATION POUR PLANCHE DE RIVE		24	3.5x50		
HS4	SCREW FOR DOOR FILLET - SCHRAUBE ZUR BEFESTIGUNG TÜRLEISTE - VIS D'ASSEMBLAGE DU CADRE DE PORTE		5	3x30		
HS12	SCREW FOR EAVES BOARDS - SCHRAUBEN FÜR TRAUFBRETT - VIS DE FIXATION POUR BANDEAU DE TOIT		14	4x40		
HS12	SCREW FOR ROOF EDGE REINFORCEMENT - SCHRAUBEN FÜR DACHRANDVERSTÄRKUNG - VIS POUR RENFORT DE BORD DE TOIT		14	4x40		
HS18	SCREW FOR FOUNDATION - SCHRAUBEN ZUR BEFESTIGUNG FUNDAMENT - VIS DE FIXATIONS DES POUTRELLES DE FONDATIONS		8	5x120		
HS18	SCREW FOR ROOF BEAMS - SCHRAUBEN FÜR DACHBALKEN - VIS POUR PANNE DE TOIT		10	5x120		
HS16	SCREW FOR 1. WALL BEAM - SCHRAUBE FÜR 1. BOHLENREIHE - VIS DE FIXATIONS 1ère RANGÉE DE MADRIERS AVEC POUTRELLES DE FONDATIONS		6	5x90		
HS16	SCREW FOR DOOR JAMB - SCHRAUBE FÜR TÜRRAHMEN - VIS DE FIXATION POUR MONTANT DE PORTE		4	5x90		
HS25	SCREW FOR DOORSTEP - SCHRAUBEN FÜR SWELLE - VIS DE FIXATION DU SEUIL DE PORTE		3	4.5x65		
NF2	ZN NAIL FOR FLOOR FILLET - ZN NÄGEL FÜR FUSSBODENLEISTE - POINTE POUR CORNIERE DE FINITION DU PLANCHER		17	1.4x40		
SH44	HAMMER BLOCK - SCHLAGHOLZ - CALLE DE FRAPPE		1			
SFS	NUT FOR STORM PROTECTION - SCHRAUBENMUTTER FÜR STURMLEISTE - ÉCROU POUR LAME ANTI-TEMPETE		8	D8		
NF4	ZN NAIL FOR ROOF - ZN NÄGEL FÜR DACHBRETT - POINTES DE FIXATIONS DES VOLIGES DE TOIT		212	2x50		
NF4	ZN NAIL FOR FLOOR - ZN NÄGEL FÜR FUSSBODENBRETT - CLOUS POUR PLANCHER		112	2x50		
NF5	ZN NAIL FOR ROOFING FELT FILLET - ZN NÄGEL FÜR DACHPAPPENLEISTE - POINTE POUR BAGUETTE FIXATION FEUTRE BITUMEUX		16	2x40		
BFS	BOLT FOR STORM PROTECTION - BOLZEN FÜR STURMLEISTE - VIS POUR LAME ANTI-TEMPETE		8	8x80		
	MALE BOLT HINGE FOR DOOR - TÜRRIEGEL - PARTIE MALE DE CHARNIERE DE PORTE		6	14/80		
GS	GABLE SEGMENT - DECKBLATT - LOSANGE DE FINITION		2			
DFS	WASHER FOR STORM PROTECTION - DICHTSCHEIBE FÜR STURMLEISTE - RONDELLE POUR LAME ANTI-TEMPETE		8	D8		
TL4	DOOR HANDLE FITTINGS - TÜRGRIF - SET DE GARNITURES DE SERRURE DE PORTE		1			
TL5	SET OF DOOR LOCK COVERS - SCHLOSSBLENDEN - SET DE GARNITURES DE SERRURE DE PORTE		1			
	CYLINDER LOCK - ZYLINDERSCHLOSS - CYLINDRE DE SERRURE		1	30/35		

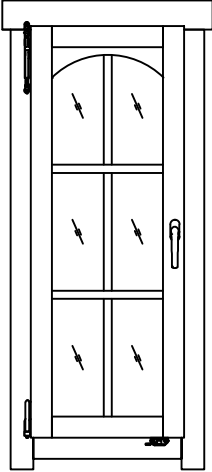
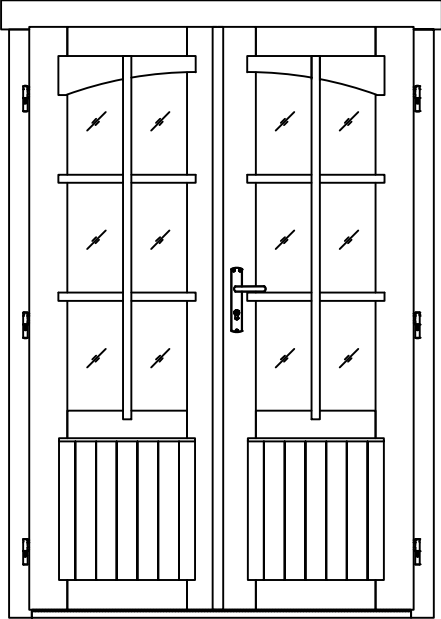
Pos	17.06.2016 Piecelist - Stücklist - Liste des composants Art. Nr. 4416540	8/8	Q.	P. (mm)	L. (mm)
	<p data-bbox="236 147 852 181">WINDOW - FENSTER - FENETRE 533x1336 DGP+A+</p> <p data-bbox="1050 147 1246 181">AK.1.106.PSV.Kg</p> 	1			
	<p data-bbox="236 730 743 763">DOOR - TÜR - PORTE 1244x1850 DGP+A+</p> <p data-bbox="970 730 1246 763">TUK.2.066.PVP.MMKWe</p> 	1			