

Barbados 2
Art. Nr. 4414502
1/8

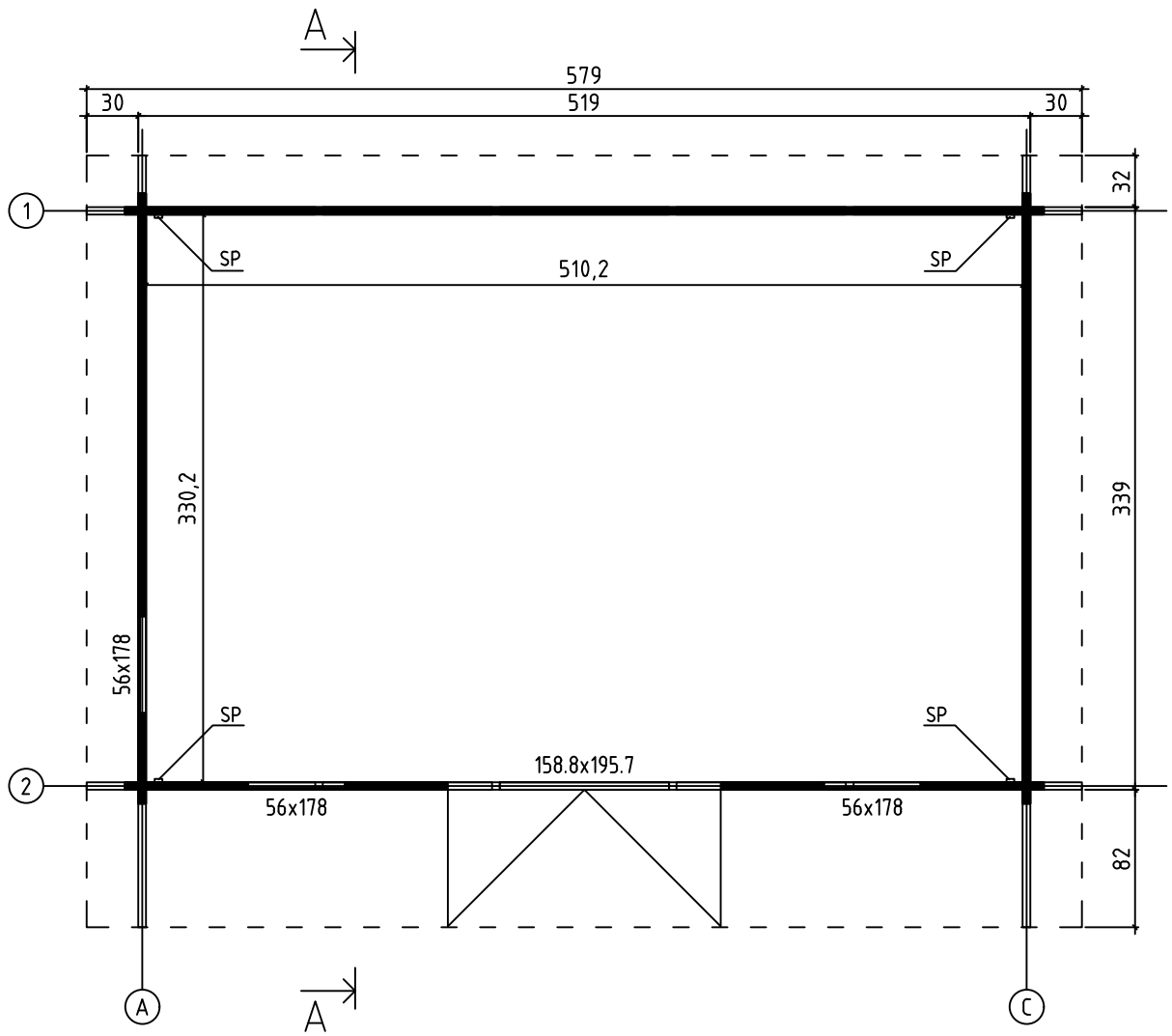

7.04.2016

GROUNDPLAN - GRUNDPLAN - PLAN DE MASSE



FOUNDATION - FUNDAMENT - FONDATION

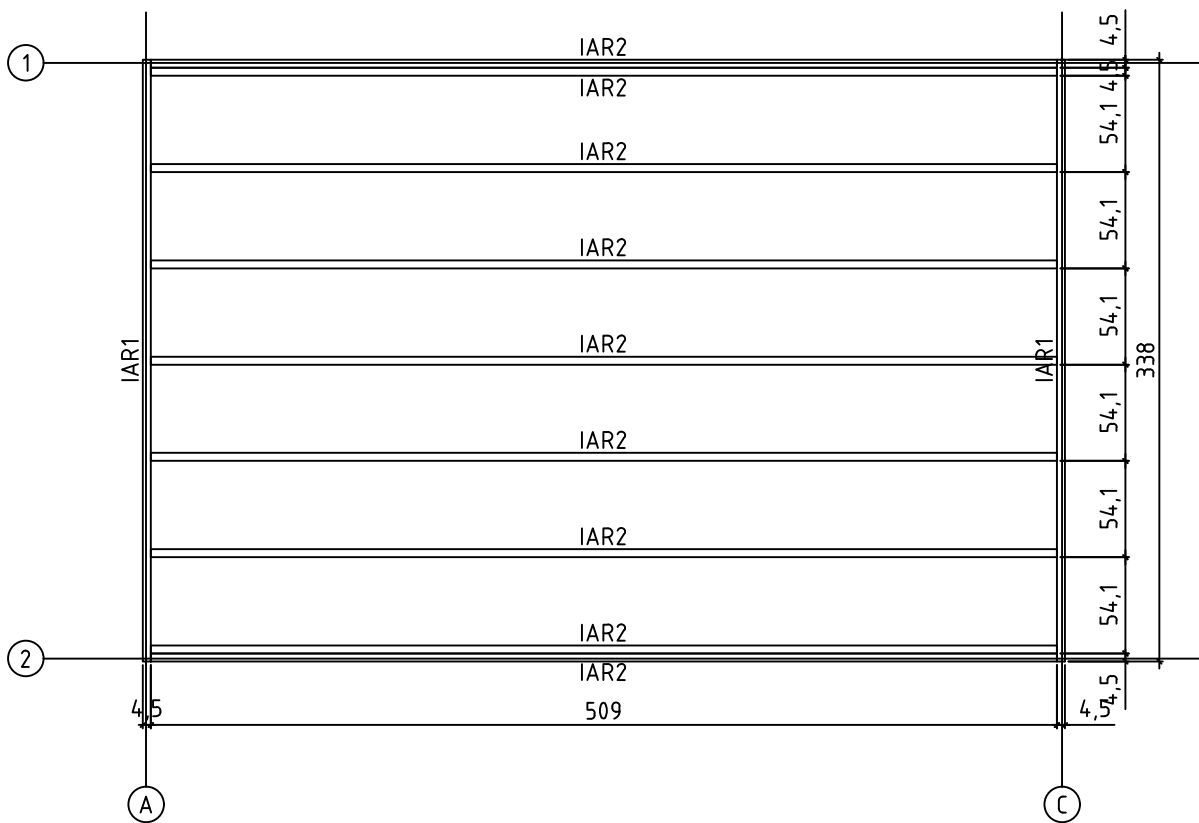



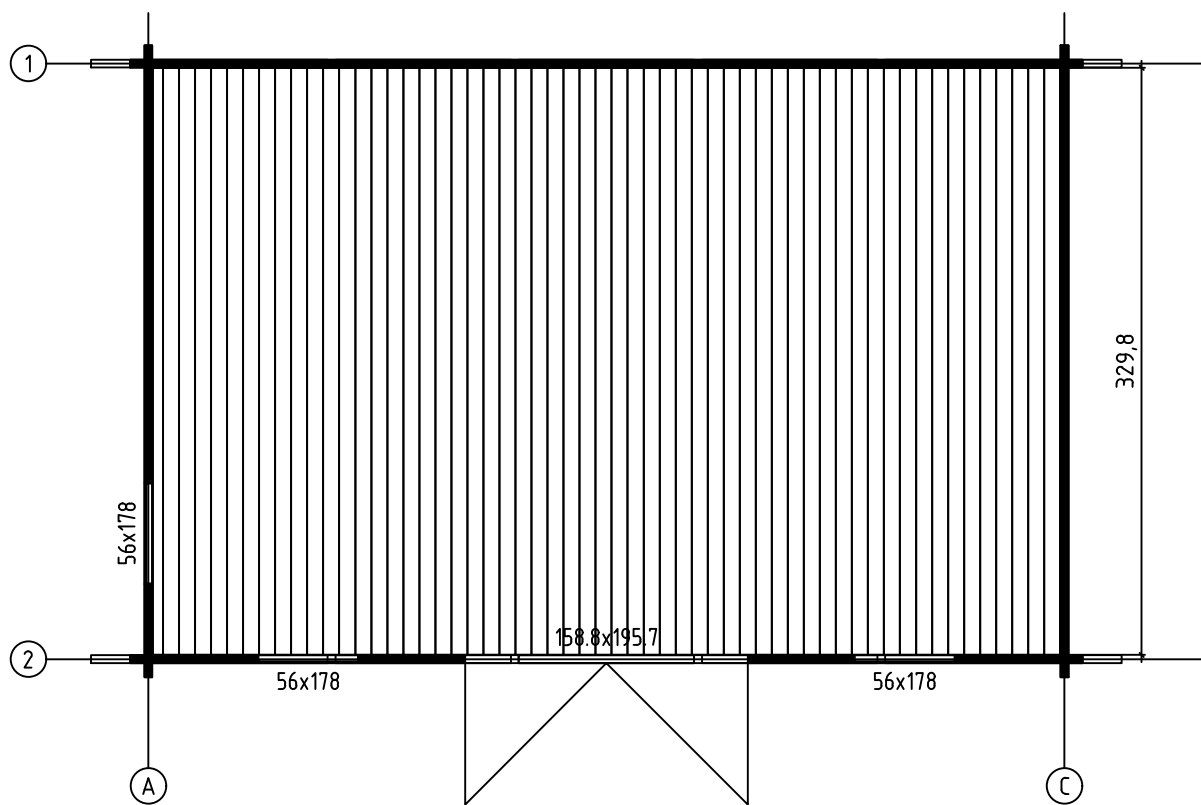

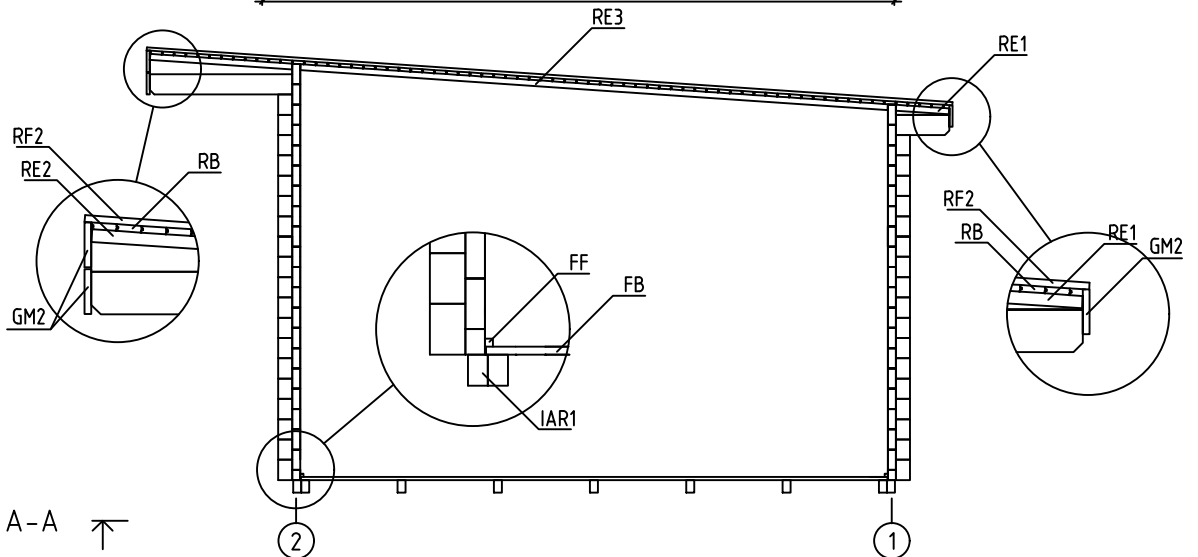
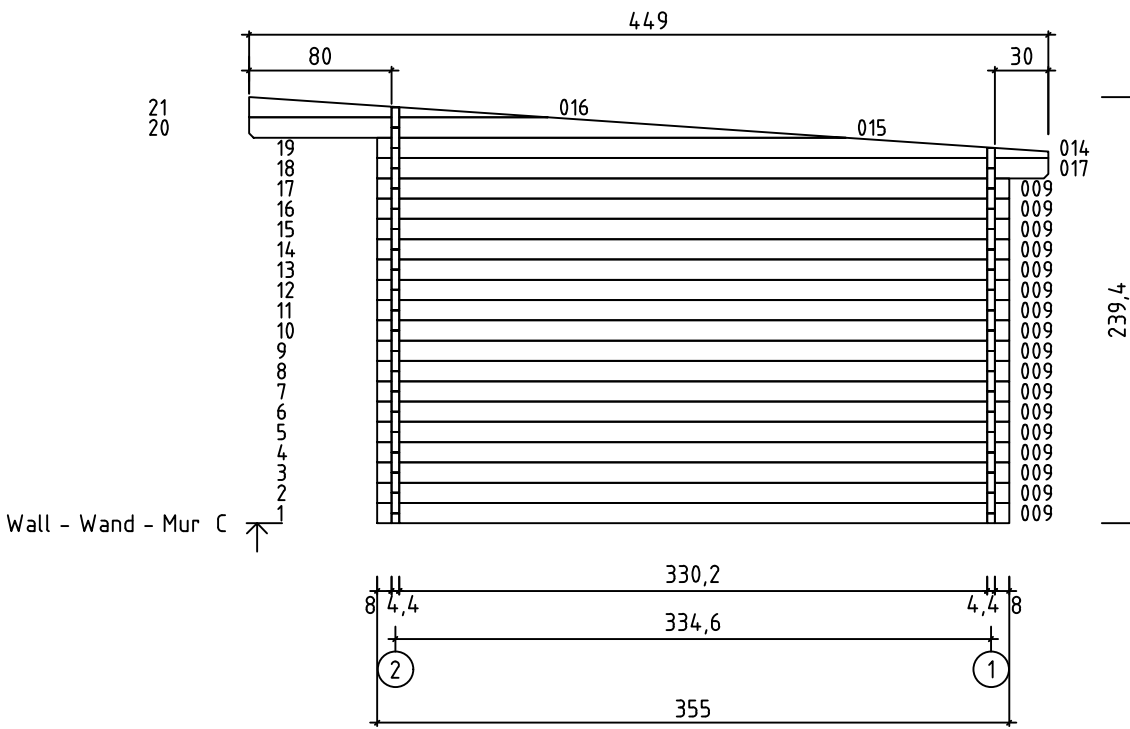
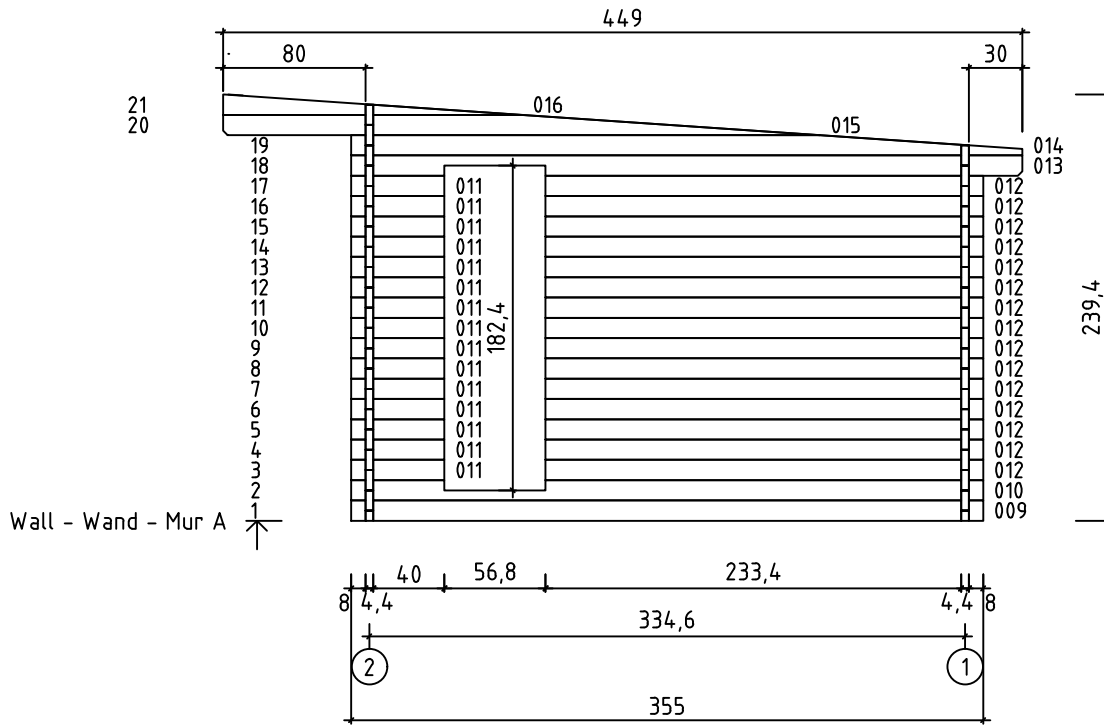

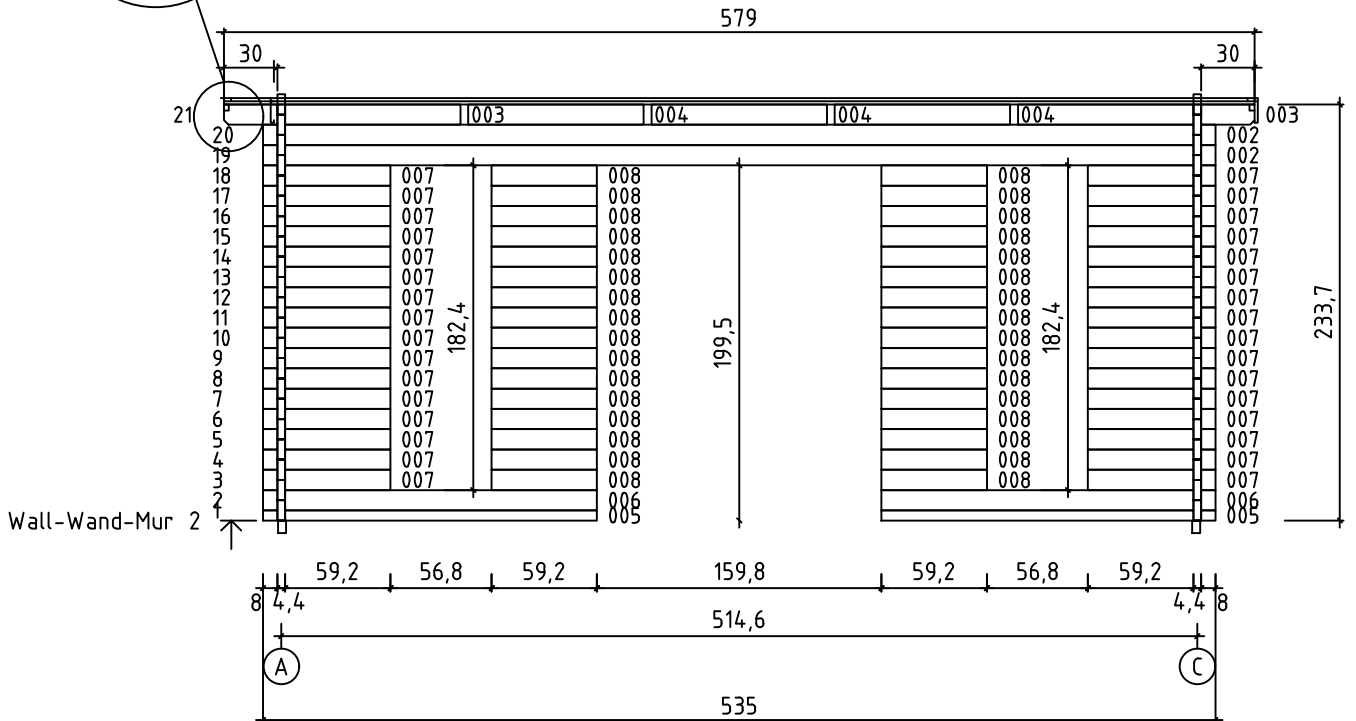
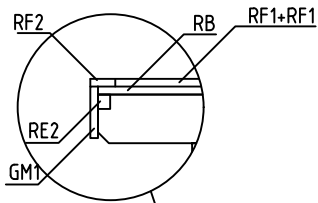
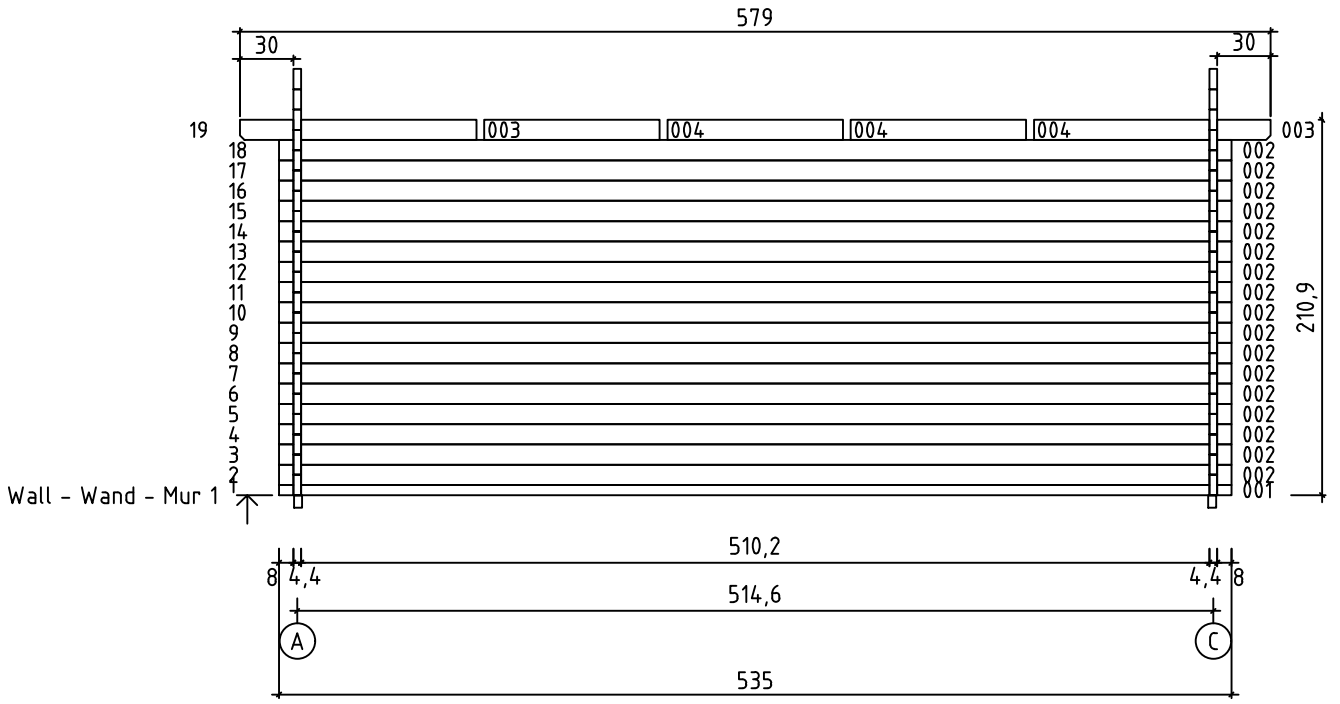

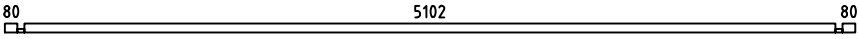
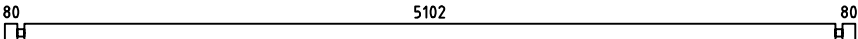
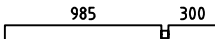
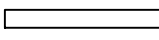
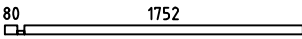
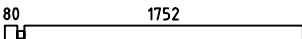
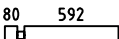

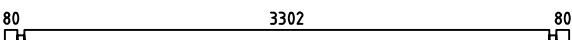
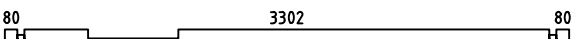

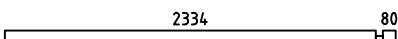
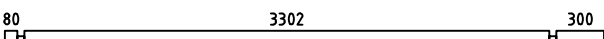
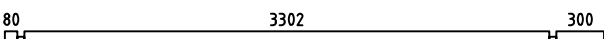
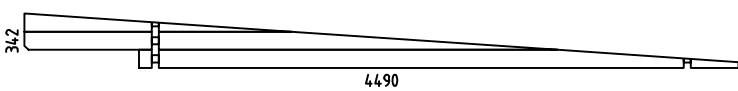
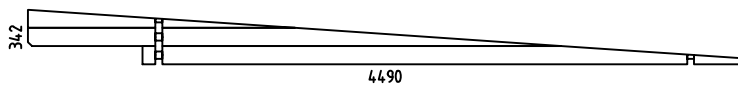

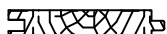
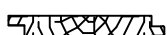



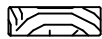
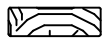



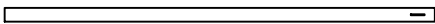
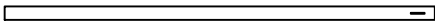
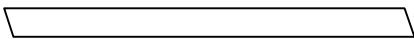
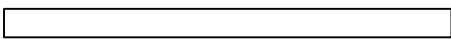
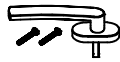
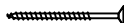

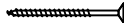
FLOOR BOARDS - FUSSBODENBRETTER - PLAN POSE PLANCHER

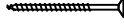
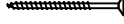

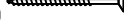



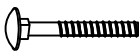

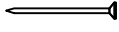
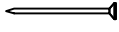

Pos	07.04.2016	Art.Nr. 4414502	6/8	Q.	P (mm)	L (mm)
001		5102	80	1	44x57	5350
002		5102	80	19	44x114	5350
003		985	300	4	44x114	1329
004				6	44x114	985
005		1752	80	2	44x57	1876
006		1752	80	2	44x114	1876
007		592	80	32	44x114	716
008				32	44x114	592
009		3302	80	18	44x114	3550
010		3302	80	1	44x114	3550
011		400	80	15	44x114	524
012		2334	80	15	44x114	2458
013		3302	80	300	44x114	3770
017		3302	80	300	44x114	3770
WA-1				1		
WC-1				1		
IAR2	FOUNDATION - FUNDAMENT - FONDATION					
IAR1	FOUNDATION - FUNDAMENT - FONDATION					
SR1	RAFTER - DACHSPARREN - CHEVRON					
FB	FLOOR BOARDS - FUSSBODENBRETTER - LAME DE PLANCHER			57	90x18	3298
RB1	ROOF BOARDS - DACHBRETTER - VOLIGES			51	90x18	4439
RB2	ROOF BOARDS - DACHBRETTER - VOLIGES			51	90x18	1351
FF	FLOOR FILLET-FUSSBODENLEISTE - CORNIERE DE FINITION DU PLANCHER				18x18	16.79

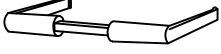
Pos	07.04.2016	Art.Nr. 4414502	7/8	Q.	P (mm)	L (mm)
RF1	ROOFING FELT FILLET - DACHPAPPENLEISTE - BAGUETTE DE FIXATION DU FEUTRE BITUMEUX			2	18x58	2855
RF2	ROOFING FELT FILLET - DACHPAPPENLEISTE - BAGUETTE DE FIXATION DU FEUTRE BITUMEUX			2	18x58	4536
RE1	ROOF EDGE REINFORCEMENT - DACHRANDVERSTÄRKUNG - CORNIERE DE RENFORT DE BORD DE TOIT			2	28x34	297
RE2	ROOF EDGE REINFORCEMENT - DACHRANDVERSTÄRKUNG - CORNIERE DE RENFORT DE BORD DE TOIT			2	28x34	800
RE3	ROOF EDGE REINFORCEMENT - DACHRANDVERSTÄRKUNG - CORNIERE DE RENFORT DE BORD DE TOIT			2	28x34	3306
SP	STORM PROTECTION - STURMLEISTE - LATTE ANTI-TEMPETE			2	22x45	2500
SP	STORM PROTECTION - STURMLEISTE - LATTE ANTI-TEMPETE			2	22x45	2050
GM1	GABLE MOULDING - GIEBELLEISTE - PLANCHE DE RIVE			2	18x120	4510
GM2	GABLE MOULDING - GIEBELLEISTE - PLANCHE DE RIVE			3	18x120	5826
	WINDOW HANDLE FITTINGS-FENSTERGRIFF - POIGNÉE D'OUVERTURE DE FENETRE			3		
	SCREW FOR GABLE MOULDING - SCHRAUBEN FÜR GIEBELLEISTE - VIS DE FIXATION POUR PLANCHE DE RIVE			66	3.5x50	
	SCREW FOR FILLET - SCHRAUBE ZUR BEFESTIGUNG TÜRLEISTE - VIS D'ASSEMBLAGE DU CADRE DE PORTE			5	3x30	
	SCREW FOR ROOF EDGE REINFORCEMENT - SCHRAUBEN FÜR DACHRANDVERSTÄRKUNG - VIS POUR RENFORT DE BORD DE TOIT			24	4x40	
	SCREW FOR ROOF BEAMS - SCHRAUBEN FÜR DACHBALKEN - VIS POUR PANNE DE TOIT			12	5x120	
	SCREW FOR GABLE - SCHRAUBEN FÜR GIEBEL - VIS POUR FIXATION DES PIGNONS			8	5x120	
	SCREW FOR 1. WALL BEAM - SCHRAUBE FÜR 1. BOHLENREIHE - VIS DE FIXATION DES FONDATIONS			8	5x90	
	SCREW FOR FUNDAMENT - SCHRAUBEN ZUR BEFISTIGUNG FUNDAMENT - VIS POUR FONDATION			26	5x90	
	SCREW FOR DOOR JAMB - SCHRAUBE FÜR TÜRRAHMEN - VIS DE FIXATION POUR MONTANT DE PORTE			4	5x90	
	SCREW FOR Pos. 004, 005 - SCHRAUBEN FÜR für Pos. 004, 005 VIS POUR FIXATION DERNIÈRE RANGÉE MADRIERS (MURS AVANT ET ARRIÈRE)			10	6x180	
	ZN NAIL FOR FLOOR FILLET - ZN NÄGEL FÜR FUSSBODENLEISTE - POINTE POUR CORNIERE DE FINITION DU PLANCHER			34	1.4x40	
	HAMMER BLOCK - SCHLAGHOLZ - CALLE DE FRAPPE			1		
	ZN NAIL FOR ROOFING FELT FILLET - ZN NÄGEL FÜR DACHPAPPENLEISTE - POINTE POUR BAGUETTE FIXATION FEUTRE BITUMEUX			34	2x40	
	NUT FOR STORM PROTECTION - SCHRAUBENMUTTER FÜR STURMLEISTE - ÉCROU POUR LAME ANTI-TEMPETE			8		
	BOLT FOR STORM PROTECTION - BOLZEN FÜR STURMLEISTE - VIS POUR LAME ANTI-TEMPETE			8		
	WASHER FOR STORM PROTECTION - DICHTSCHEIBE FÜR STURMLEISTE - RONDELLE POUR LAME ANTI-TEMPETE			8		

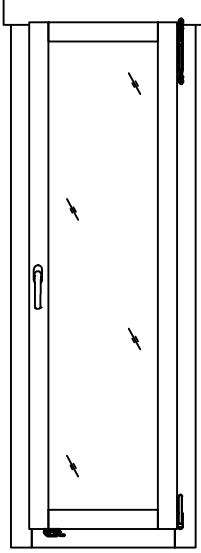
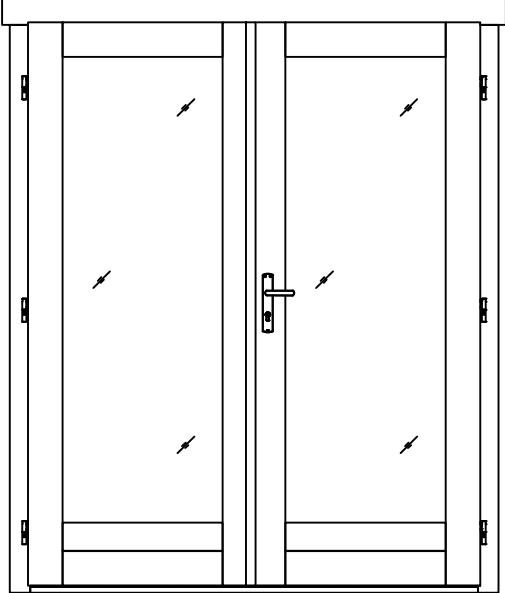
Pos	07.04.2016	Art.Nr. 4414502	8/8	Q.	P (mm)	L (mm)
	ZN NAIL FOR ROOF - ZN NÄGEL FÜR DACHBRETTER - POINTE POUR TOIT			374	2x50	
	ZN NAIL FOR FLOOR - ZN NÄGEL FÜR FUSSBODENBRETTER - CLOUS POUR PLANCHER			406	2x50	
	SET OF DOOR LOCK COVERS - SCHLOSSBLENDEN - SET DE GARNITURES DE SERRURE DE PORTE			1		
	MALE BOLT HINGE FOR DOOR - TÜRRIEGEL - PARTIE MALE DE CHARNIERE DE PORTE			6		
	DOOR HANDLE FITTINGS-TÜRGRIFF - SET DE GARNITURES DE SERRURE DE PORTE			1		
	CYLINDER -ZYLINDERSCHLOSS - CYLINDRE DE SERRURE			1	30x35	
	WINDOW-FENSTER-FENETRE 560x1780 AK.1.100.PSP DGP+			3		
	DOOR-TÜR-PORTE 1588x1957 TUK.1.100.PVP.MM DGP+			1		