

Barbados 3 70mm
Art.No. 7011602

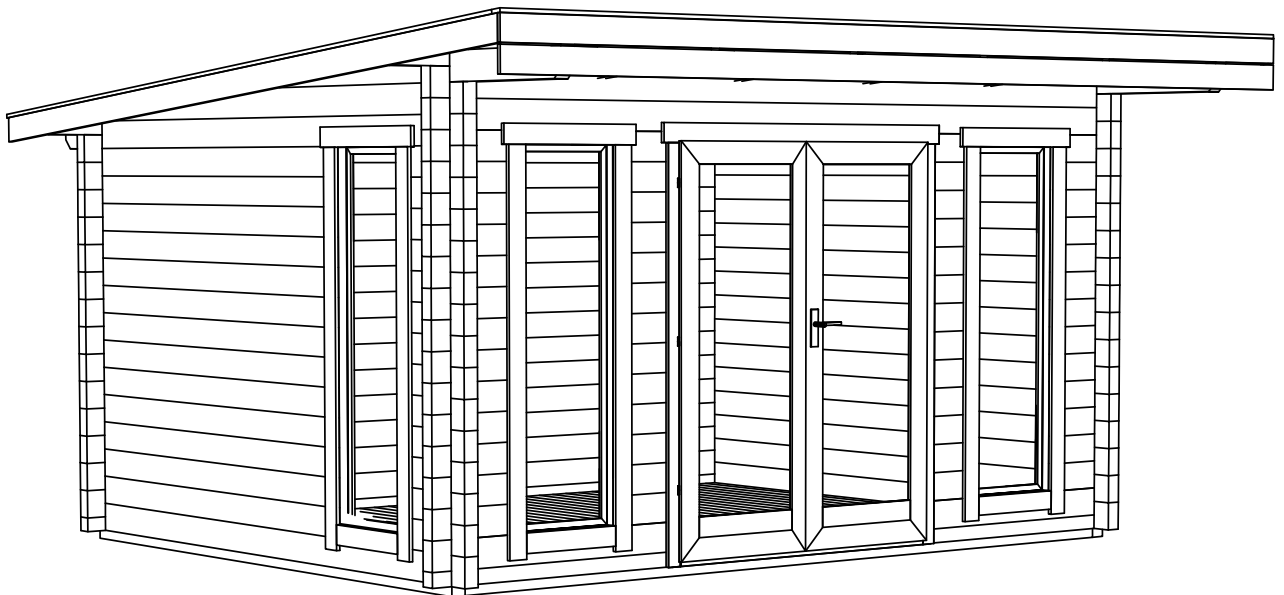

Barbados 3 70mm, Art.No. 7011602
 GROUNDPLAN - GRUNDPLAN - PLAN DE MASSE

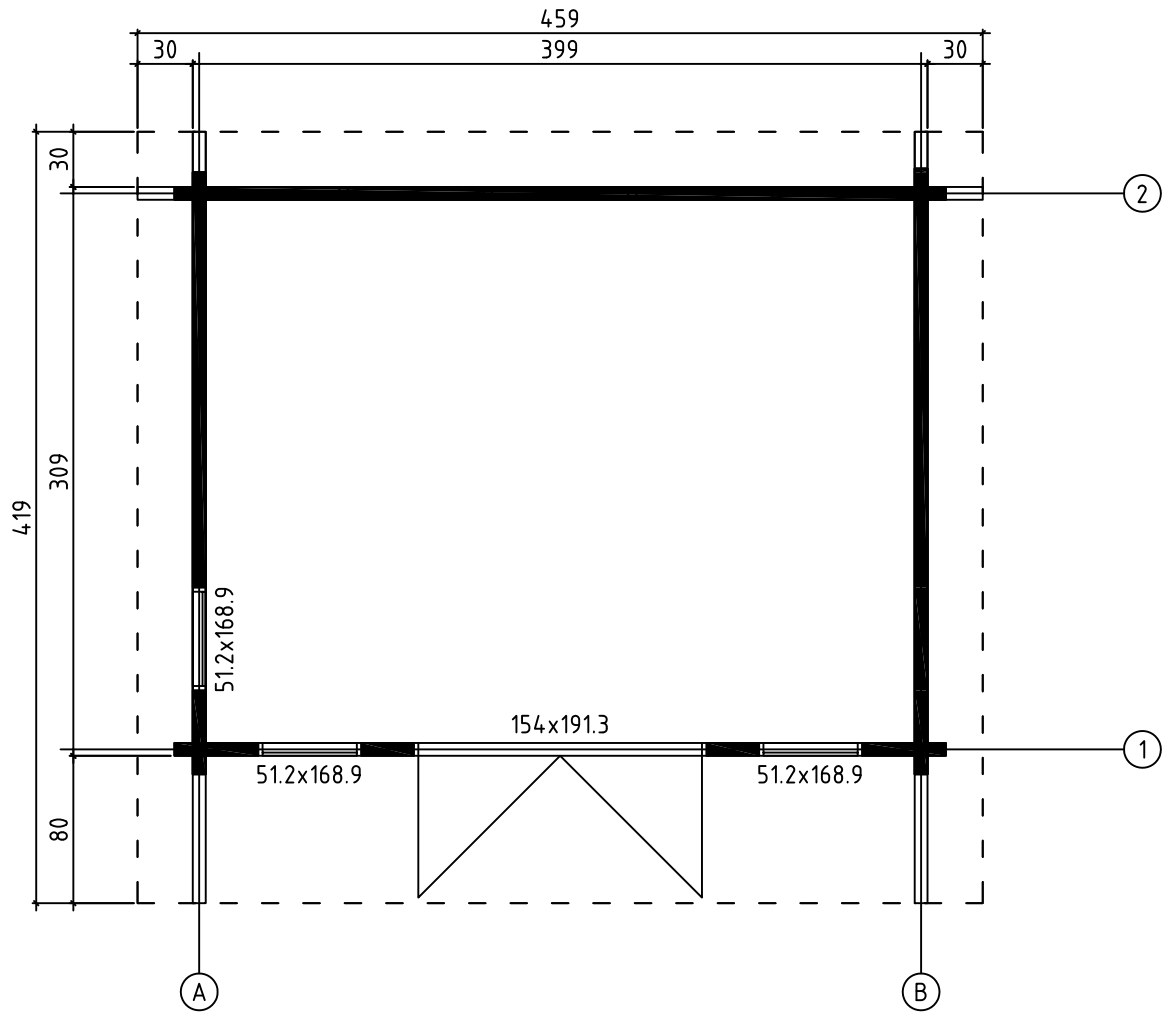

FOUNDATION - FUNDAMENT - FONDATION

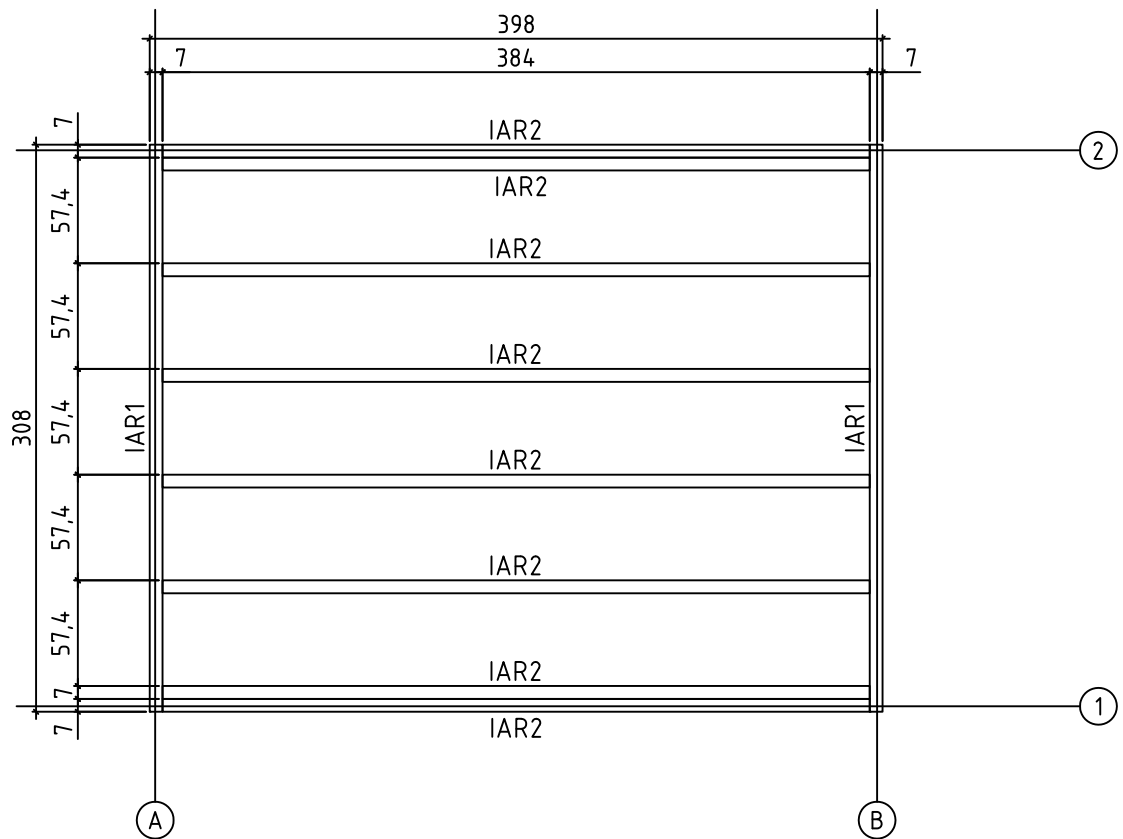

Barbados 3 70mm, Art.No. 7011602
RAFTERS PLAN - DACHSPARREN - PLAN DE CHEVRON

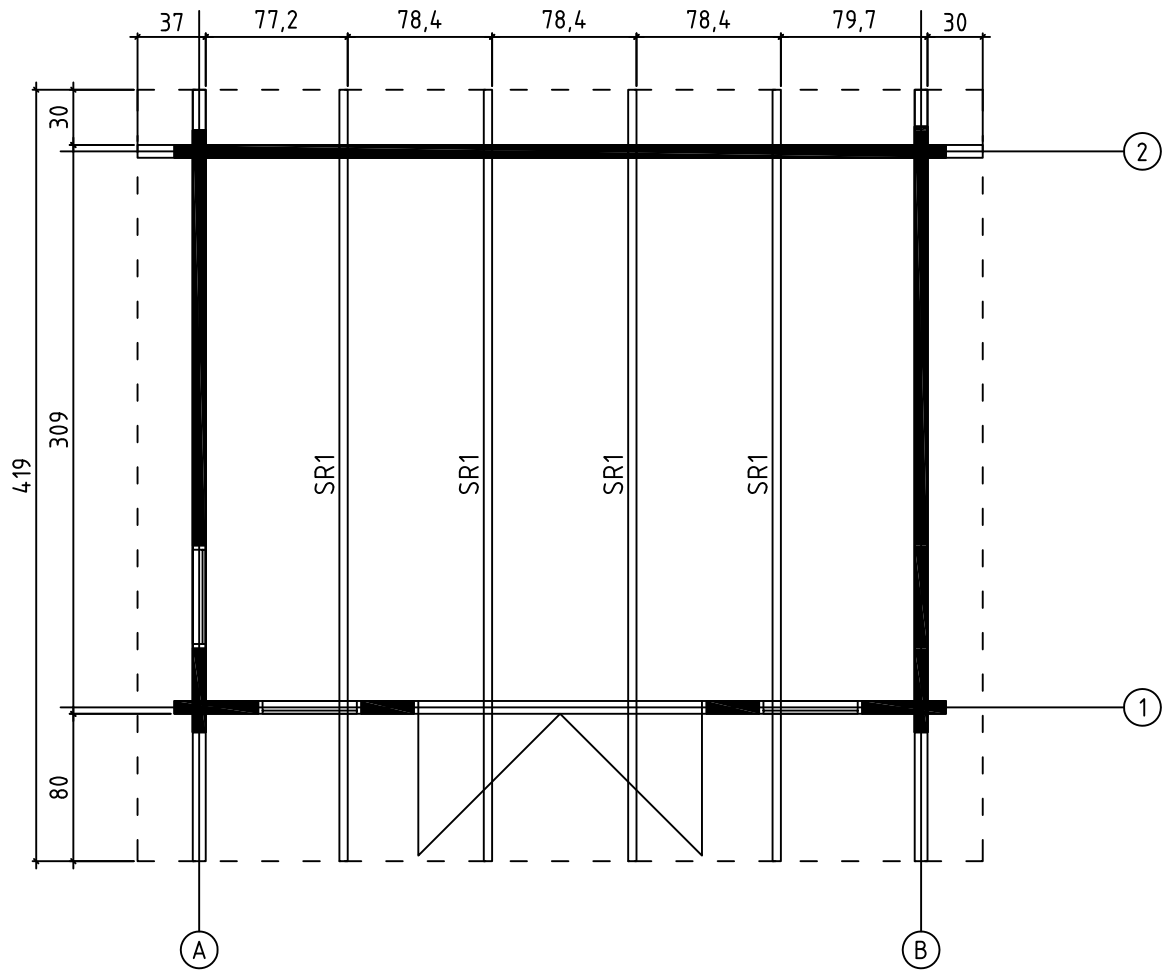



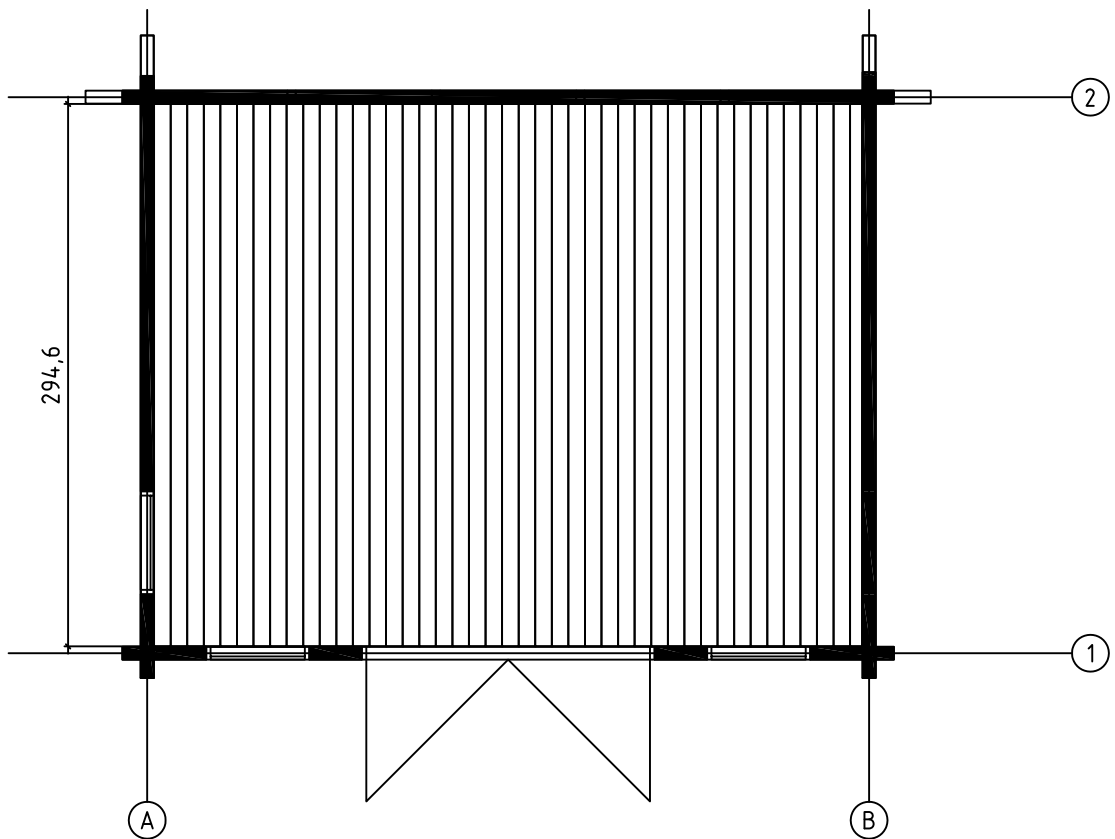

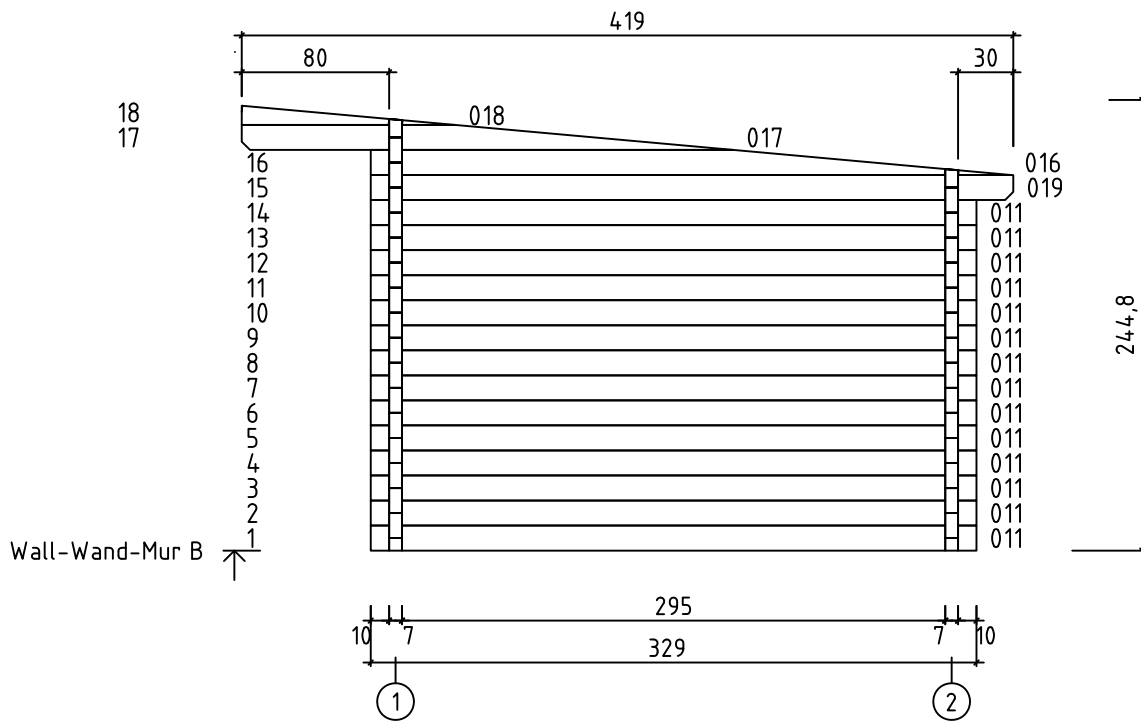
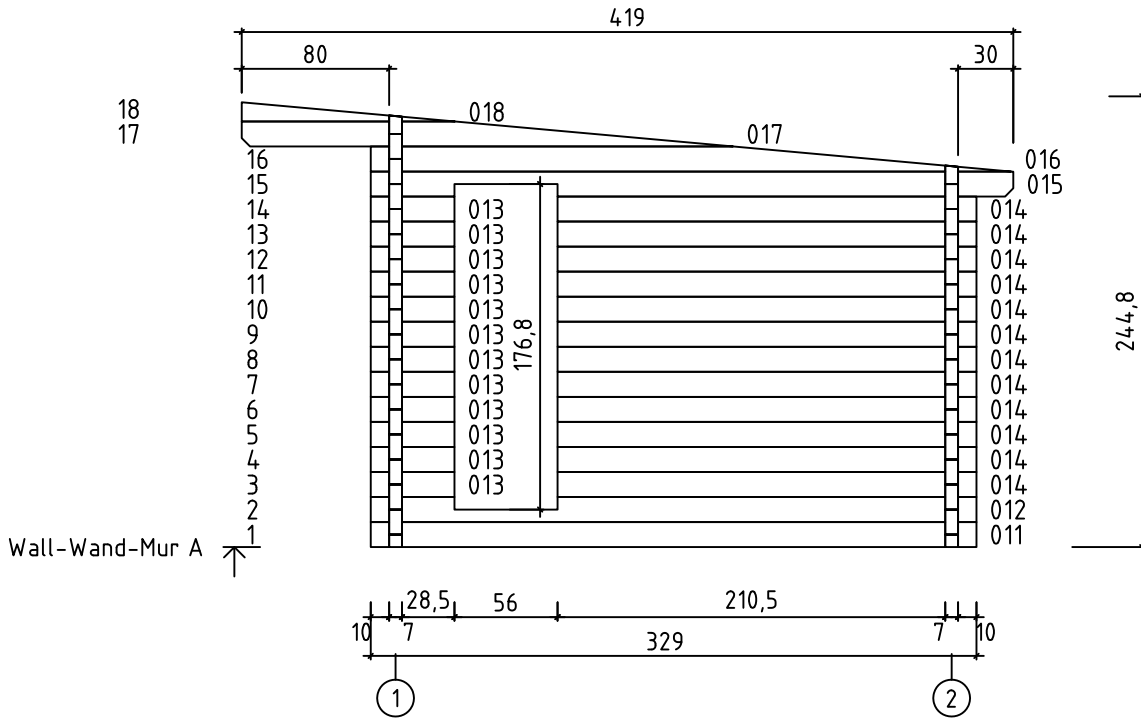

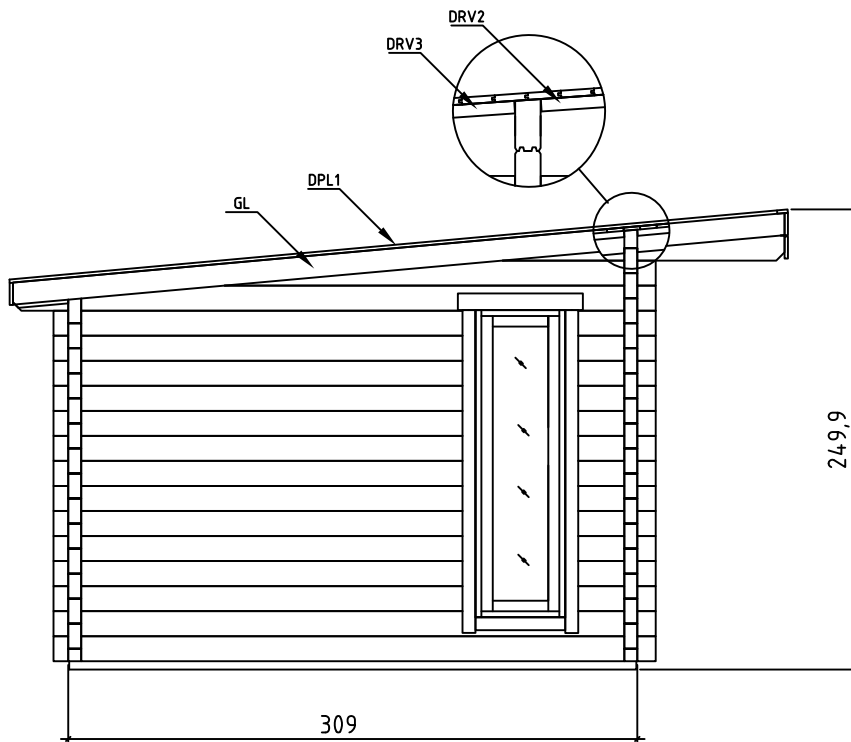
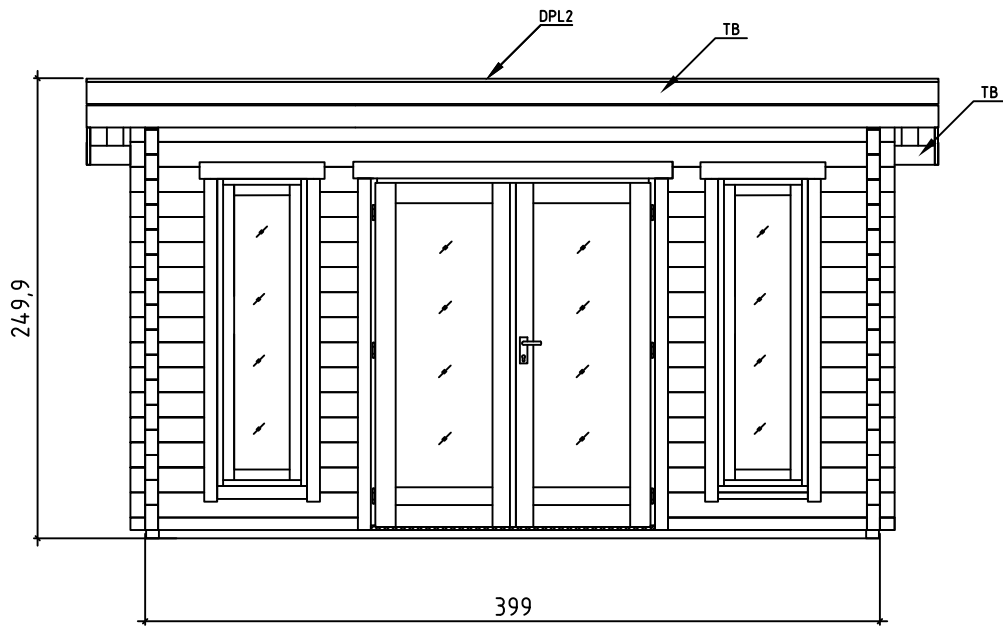

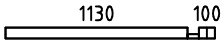
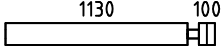

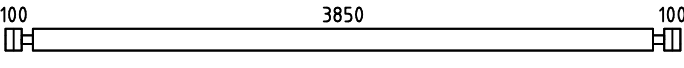
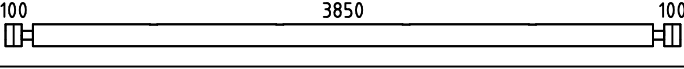
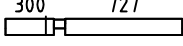
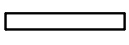
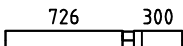
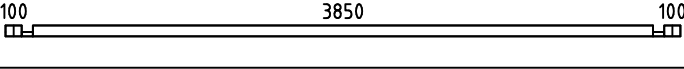
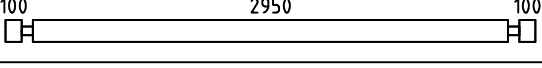
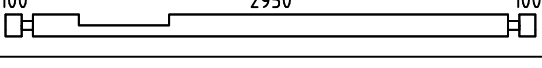

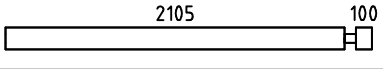
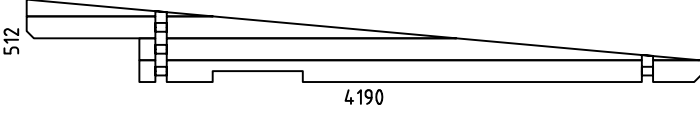
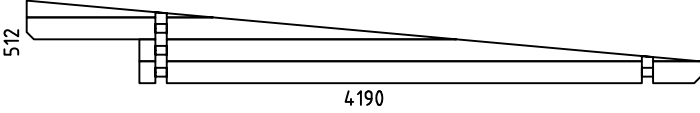
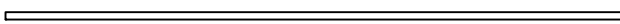
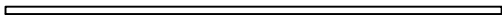















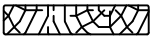

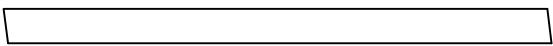
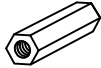

FLOOR BOARDS - FUSSBODENBRETTER - PLAN POSE PLANCHER



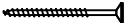
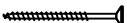

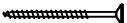

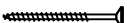
Pos	Barbados 3 70mm, Art.No. 7011602 Piece list - Stückliste - Liste des pieces	Q.	P (mm)	L (mm)
001		2	70x68	1300
002		2	70x136	1300
003		26	70x136	455
004		26	70x136	285
005		14	70x136	4190
006		2	70x136	4190
007		2	70x100	1097
008		6	70x100	739
009		2	70x100	1096
010		1	70x68	4190
011		15	70x136	3290
012		1	70x136	3290
013		12	70x136	455
014		12	70x136	2275
WA-1		1		
WB-1		1		
IAR2	FOUNDATION - FUNDAMENT - FONDATION 	8	70x45	3840
IAR1	FOUNDATION - FUNDAMENT - FONDATION 	2	70x45	3080
SR1	RAFTER - DACHSPARREN - CHEVRON 	4	45x140	4220
	FLOOR BOARDS - FUSSBODENBRETTER - LAME DE PLANCHER 	43	90x18	2946
	ROOF BOARDS - DACHBRETTER - VOLIGES 	47	90x18	4590
	FLOOR FILLET-FUSSBODENLEISTE - CORNIERE DE FINITION DU PLANCHER 		18x18	13.6 m.
DPL1	ROOFING FELT FILLET - DACHPAPPENLEISTE - BAGUETTE DE FIXATION DU FEUTRE BITUMEUX 	2	18x58	4185

Pos	Barbados 3 70mm, Art.No. 7011602 Piece list - Stückliste - Liste des pieces	Q.	P (mm)	L (mm)
DPL2	ROOFING FELT FILLET - DACHPAPPENLEISTE - BAGUETTE DE FIXATION DU FEUTRE BITUMEUX 	1	18x58	4628
M12	TREADED ROD M12 - GEWINDESTANGE M12 - TIGE FILETÉE M12 	2		100
M12	TREADED ROD M12 - GEWINDESTANGE M12 - TIGE FILETÉE M12 	2		375
M12	TREADED ROD M12 - GEWINDESTANGE M12 TIGE FILETÉE M12 	4		2000
LPL	FIXING FILLET - FIXIRUNGSLEISTE - PROFIL DE FIXATION 	6	20x70	512
LPL	FIXING FILLET - FIXIRUNGSLEISTE - PROFIL DE FIXATION 	1	20x70	1540
LPL	FIXING FILLET - FIXIRUNGSLEISTE - PROFIL DE FIXATION 	6	20x70	1729
LPL	FIXING FILLET - FIXIRUNGSLEISTE - PROFIL DE FIXATION 	2	20x70	1933
TB	EAVES BOARD - TRAUFBRETT - BANDEAU DE TOIT 	3	18x120	4628
DRV1	ROOF EDGE REINFORCEMENT - DACHRANDVERSTÄRKUNG - CORNIERE DE RENFORT DE BORD DE TOIT 	2	28x34	297
DRV2	ROOF EDGE REINFORCEMENT - DACHRANDVERSTÄRKUNG - CORNIERE DE RENFORT DE BORD DE TOIT 	2	28x34	798
DRV3	ROOF EDGE REINFORCEMENT - DACHRANDVERSTÄRKUNG - CORNIERE DE RENFORT DE BORD DE TOIT 	2	28x34	2958
GL	GABLE MOULDING - GIEBELLEISTE PLANCHE DE RIVE 	2	18x120	4218
KL4	LENGTHENING BOLT FOR TREADED ROD - VERLÄNGERUNGSMUTTER FÜR GEWINDESTANGE - MANCHON DE RACCORDEMENT DE TIGE FILETÉE 	4		
KL1	DRIVE NUT TREADED ROD - EINSHLAGMUTTER FÜR GEWINDESTANGE - ÉCROU A FRAPPER POUR TIGE FILETÉE 	4		
KL2	NUT FOR TREADED ROD - MUTTER FÜR GEWINDESTANGE - ÉCROU POUR TIGE FILETÉE 	4		
KL3	PLAIN WASHER TREADED ROD - UNTERLEGSCHLEIBE FÜR GEWINDESTANGE - RONDELLE PLATE POUR TIGE FILETÉE 	4		
HS83	SCREW FOR FIXING FILLET - SCHRAUBEN FÜR FIXIRUNGSLEISTE VIS POUR PROFIL DE FIXATION 	63	3.5x50	
HS32	SCREW FOR EAVES BOARDS - SCHRAUBEN FÜR TRAUFBRETT VIS DE FIXATION POUR BANDEAU DE TOIT 	37	3.5x50	
HS16	SCREW FOR GABLE MOULDING - SCHRAUBEN FÜR GIEBELLEISTE VIS DE FIXATION POUR PLANCHE DE RIVE 	22	3.5x50	
NFD	SCREW FOR ROOFING FELT FILLET - SCHRAUBEN FÜR DACHPAPPEN- LEISTE - VIS POUR BAGUETTE FIXATION FEUTRE BITUMEUX 	28	4x40	
HS26	SCREW FOR ROOF EDGE REINFORCEMENT - SCHRAUBEN FÜR DACHRANDVERSTÄRKUNG - VIS POUR RENFORT DE BORD DE TOIT 	24	4x40	
HS40	SCREW FOR 1. WALL BEAM - SCHRAUBE FÜR 1. BOHLENREIHE VIS DE FIXATION DES FONDATIONS 	7	5x120	
HS39	SCREW FOR FUNDAMENT - SCHRAUBEN ZUR BEFESTIGUNG FUNDAMENT - VIS POUR FONDATION 	24	5x120	
HS42	SCREW FOR GABLE - SCHRAUBEN FÜR GIEBEL - VIS POUR FIXATION DES PIGNONS 	6	5x120	

