

Dundee 44
Art. Nr. 4419802
1/11

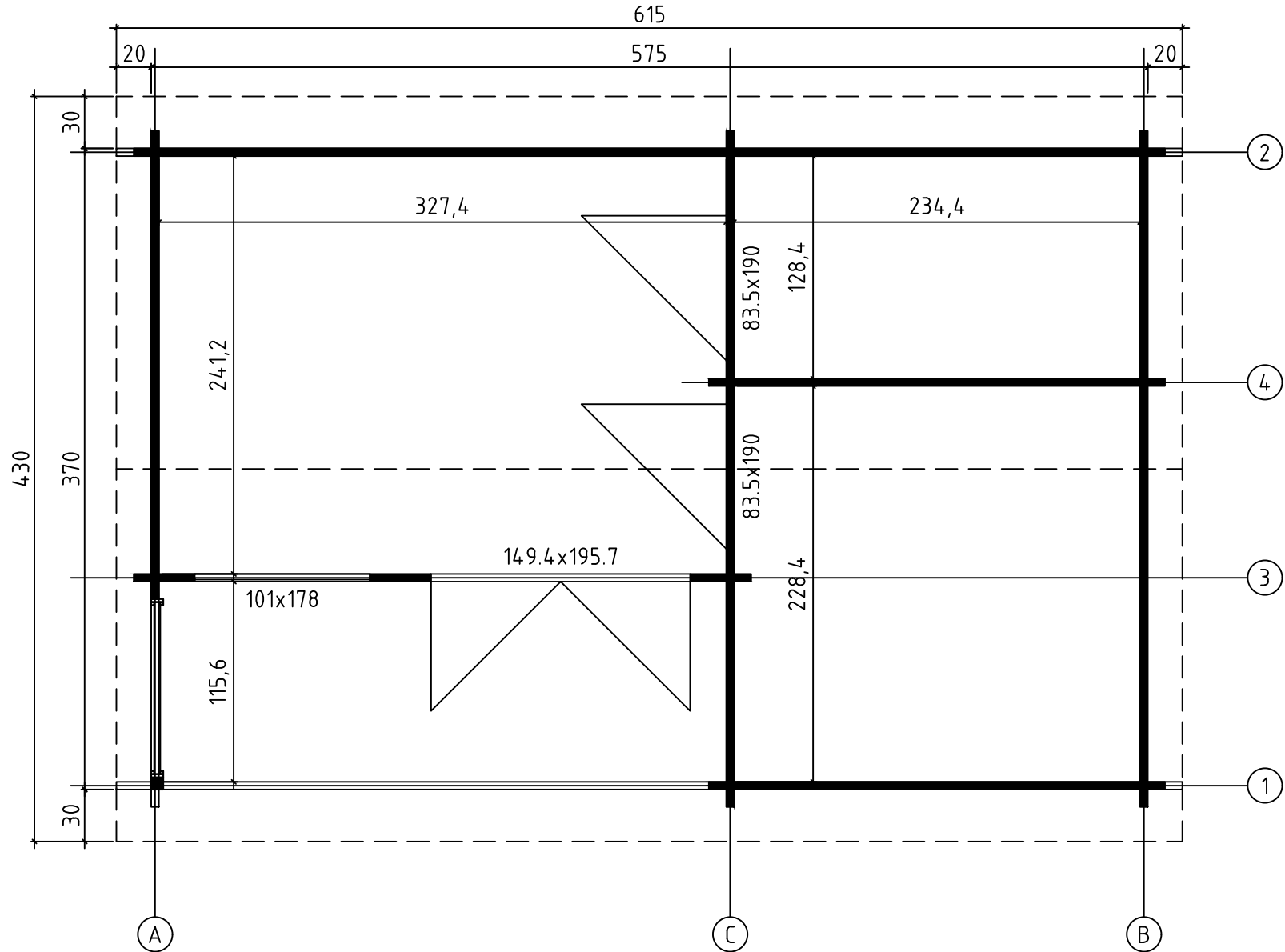

Art.Nr. 4419802

GROUNDPLAN - GRUNDPLAN - PLAN DE MASSE



FOUNDATION - FUNDAMENT - FONDATION

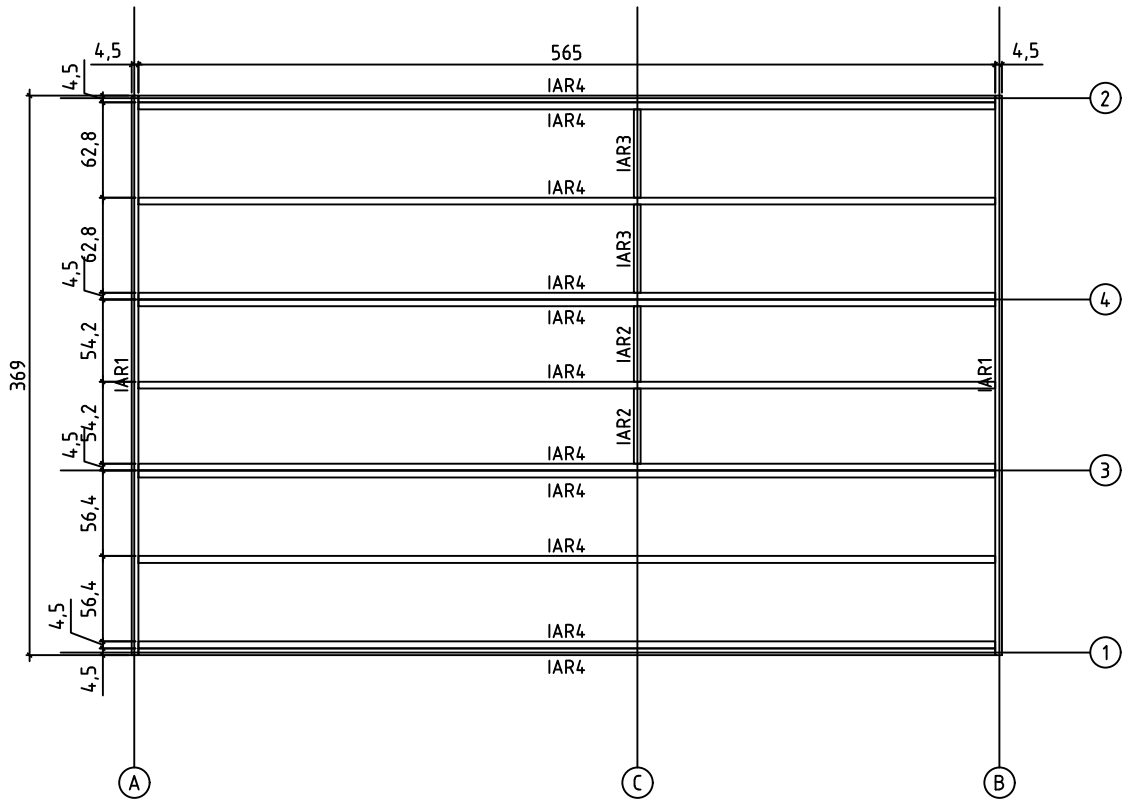

FLOOR BOARDS - FUSSBODENBRETTER - LAME DE PLANCHER
 TERRACE BOARDS - TERRASSENBRETTER - PLANCHER DE TERRASSE

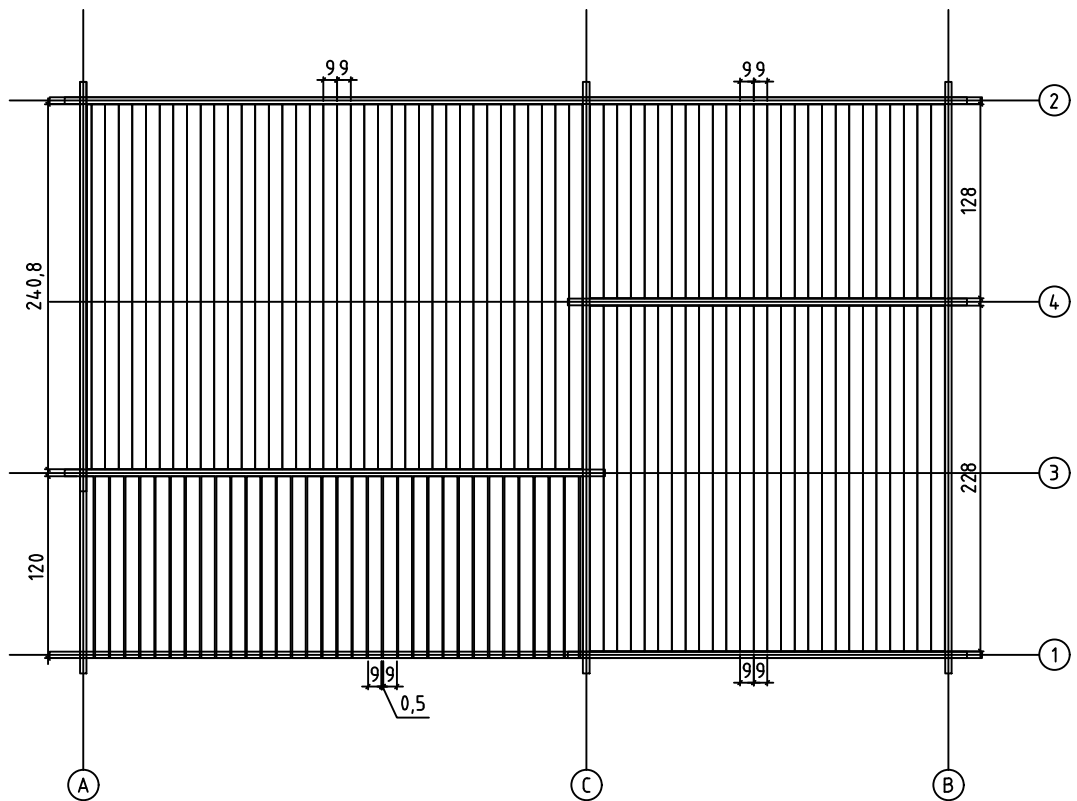

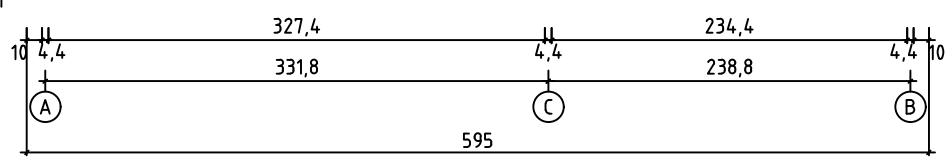
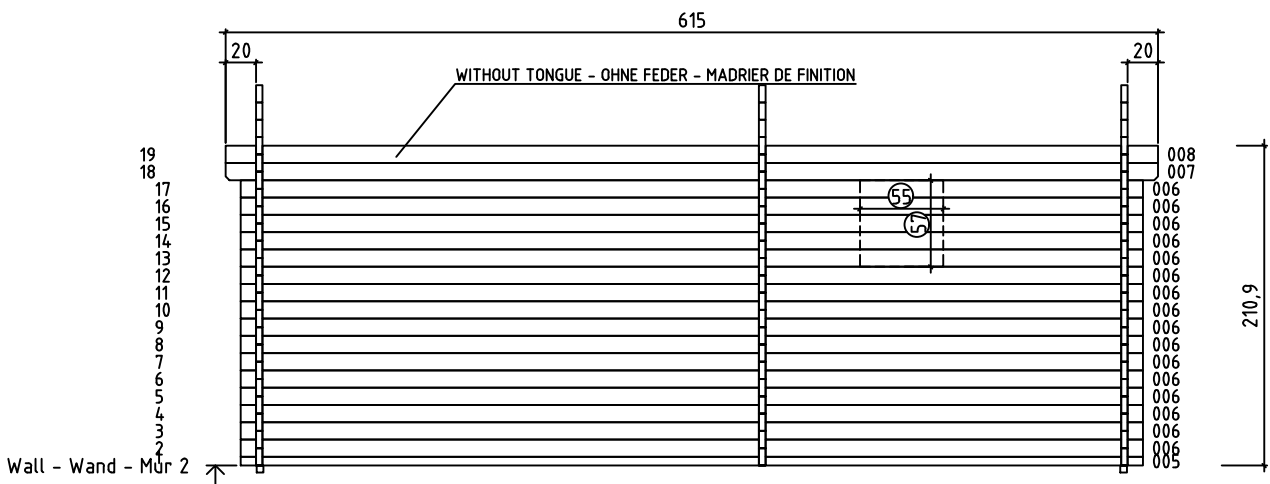
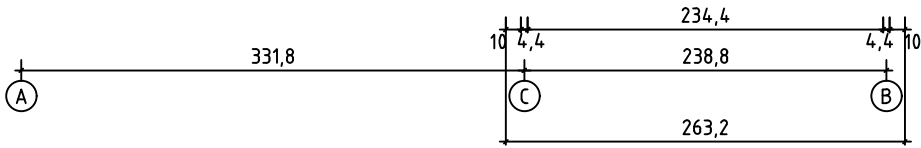
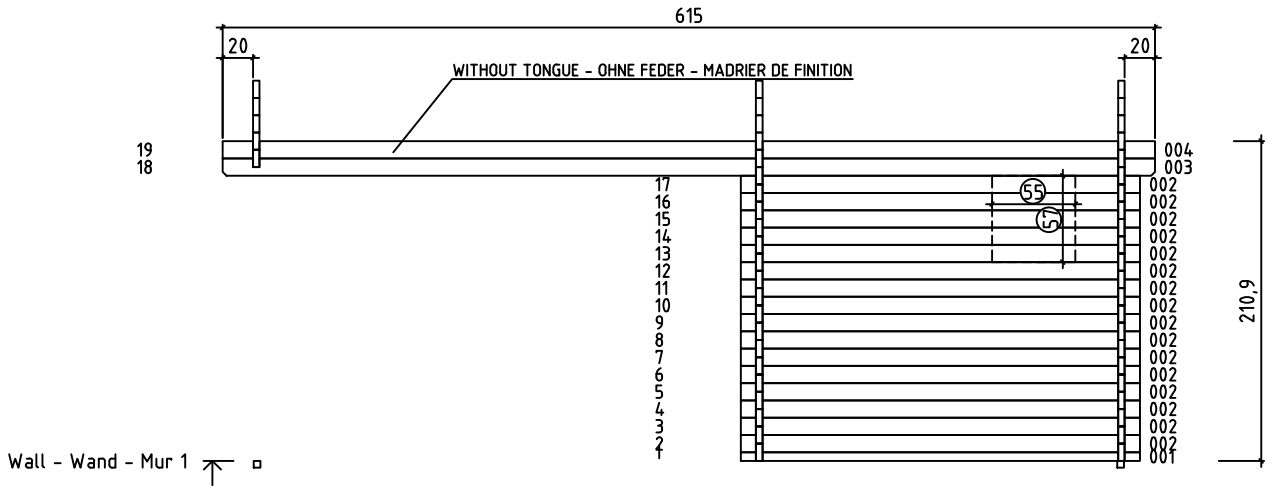

TWO SINGLE WINDOWS (54x54 CM) HAVE BEEN DELIVERED TOGETHER WITH THE BUILDING. YOU CAN CHOOSE THE LOCATION FOR THE WINDOWS BY YOURSELF BY CUTTING THE WALL LOGS AS SHOWN IN THE PICTURE (SEE THE DOTTED LINE)

IM LIEFERUMFANG SIND ZWEI EINZELFENSTER ENTHALTEN. WERKSSEITIG SIND HIERFÜR KEINE AUSSPARUNGEN VORGESEHEN SO DASS SIE DIE EXAKTEN POSITIONEN DER FENSTER SELBST WÄHLEN KÖNNEN. EINE ANLEITUNG HIERFÜR ENTNEHMEN SIE BITTE DER MONTAGEANLEITUNG (SIEHE BILD)



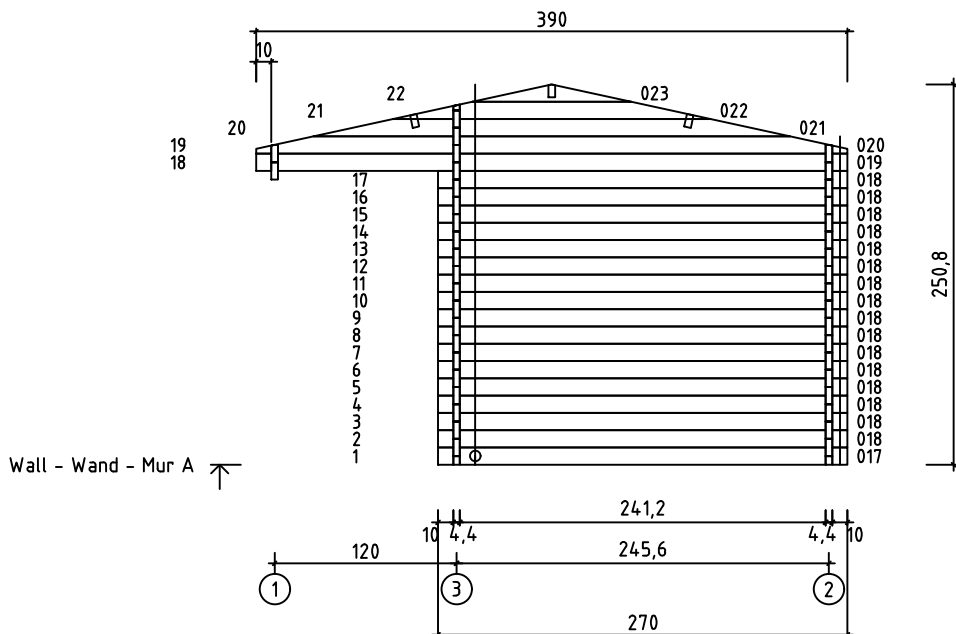
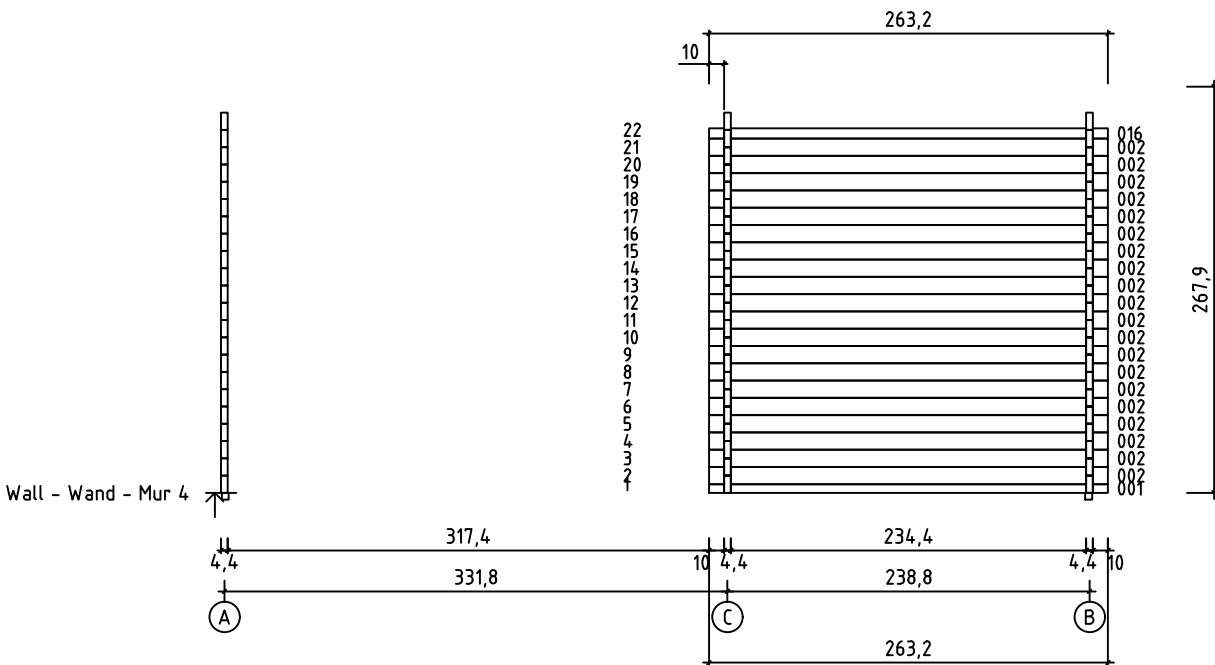
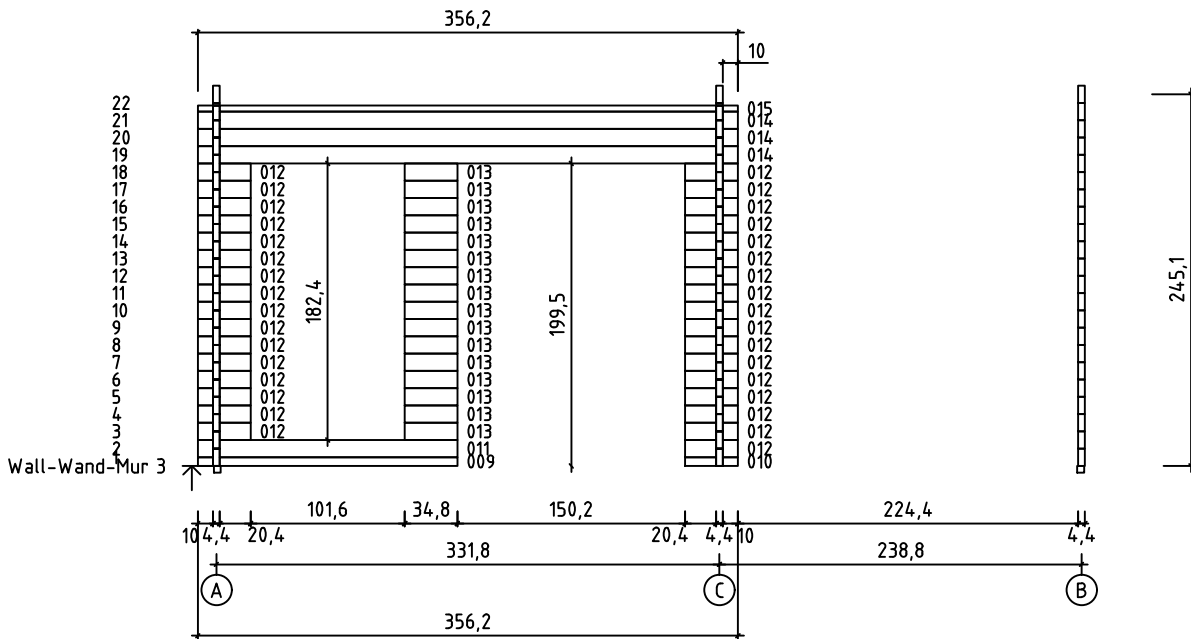

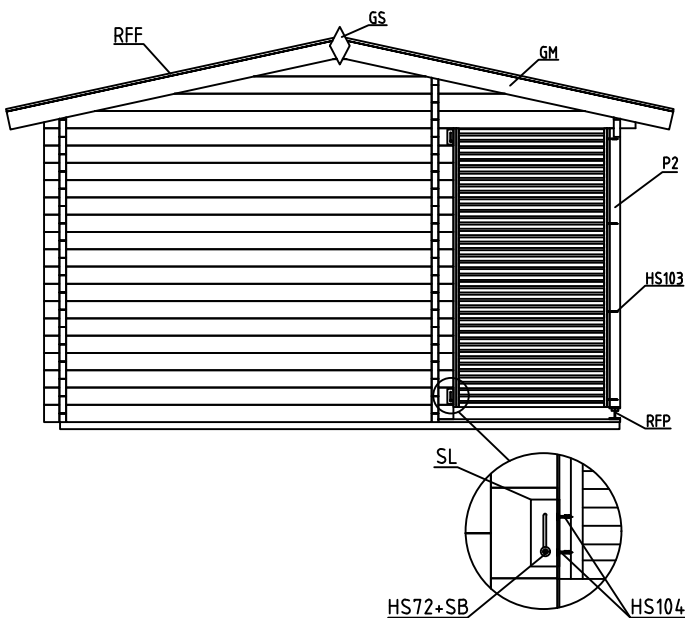
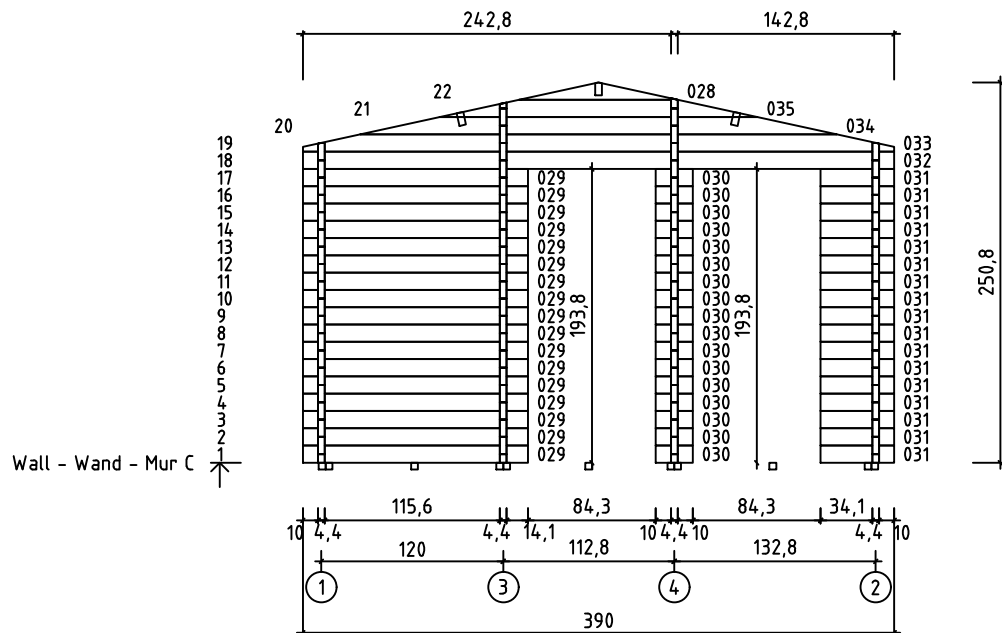
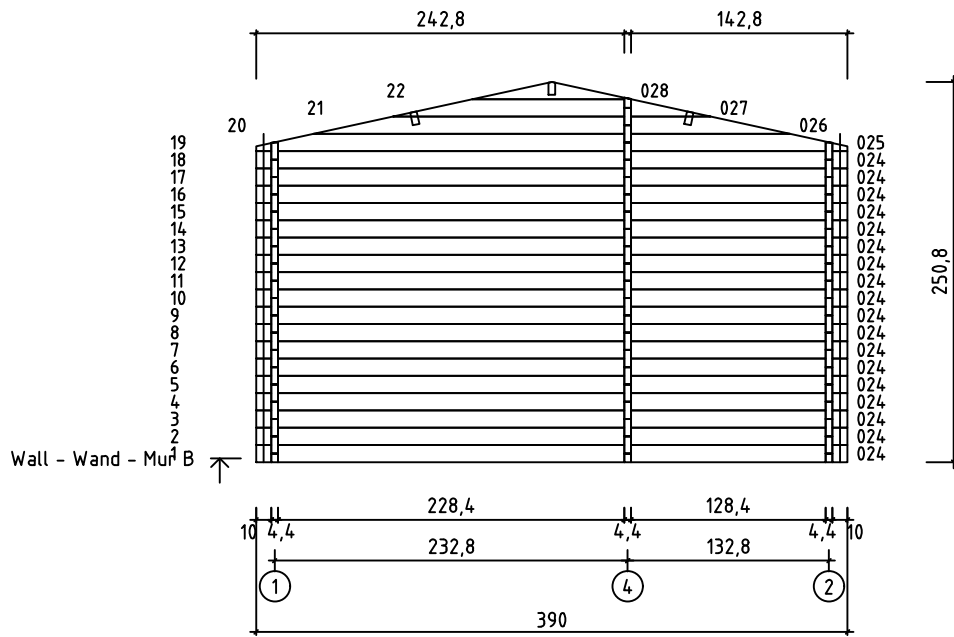



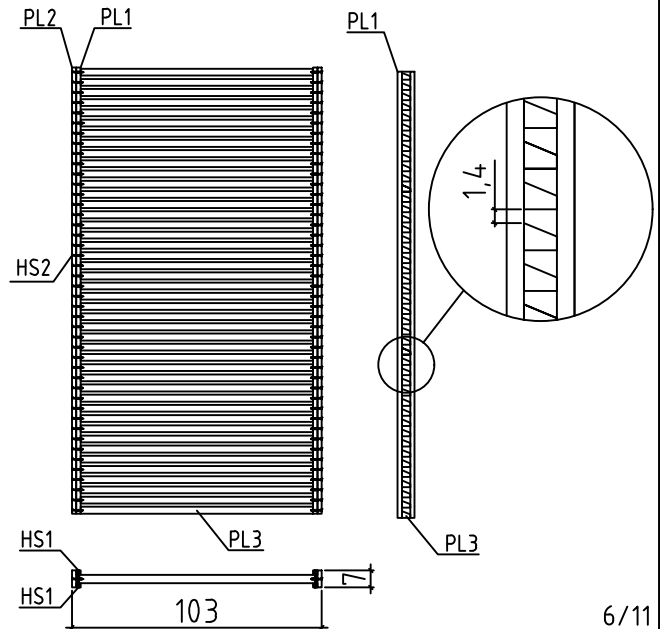

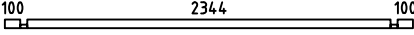
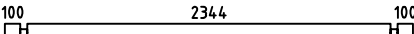



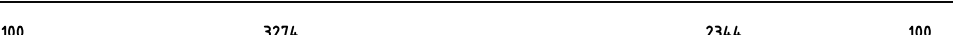

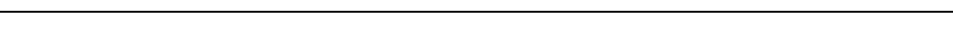
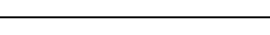
LES DEUX FENÊTRES SONT FOURNIES AVEC CET ABRU DU JARDIN. SELON VOTRE CONVENANCE, VOUS POUVEZ CHOISIR LA POSITION POUR CES FENÊTRES ET COUPER LES MADRIERS COMME MARQUE SUR L'IMAGE.





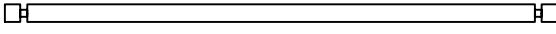
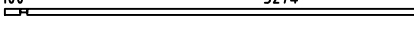
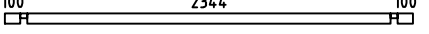
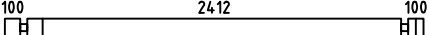
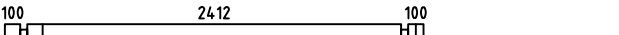
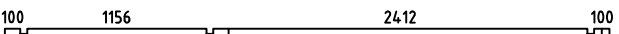





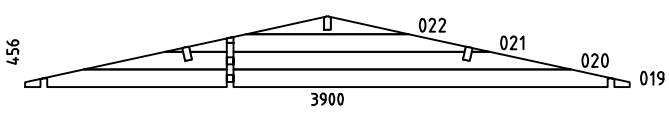
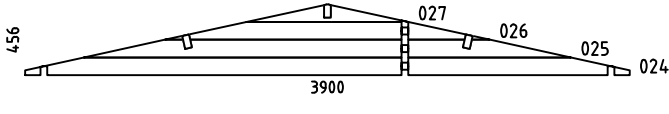
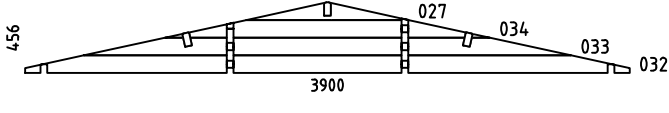

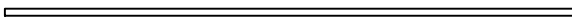

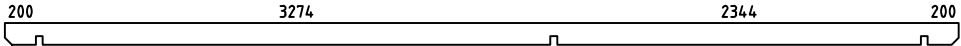
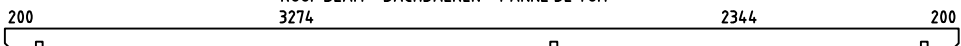



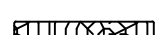

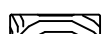
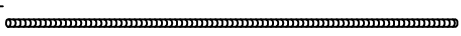
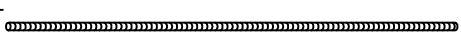

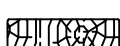



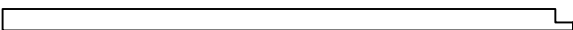
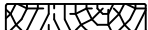





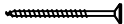
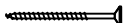
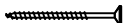
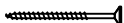



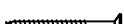









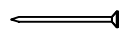

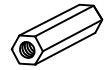

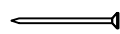
TERRACE RAILING - TERRASSE GARDE -
CORPS DE TERRASSE

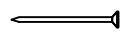

Pos	14.07.2016	Piece list - Stückliste - Liste des pièces Art.Nr. 4419802	7/11	Q.	P (mm)	L (mm)
001				2	44x57	2632
002				36	44x114	2632
003				1	44x114	6150
004	□			1	44x120	6150
005				1	44x57	5950
006				16	44x114	5950
007				1	44x114	6150
008	□			1	44x120	6150
009				1	44x57	1712
010				1	44x57	348
011				1	44x114	1712
012				33	44x114	348
013				16	44x114	348
014				3	44x114	3562
015	□			1	44x39	3562
016	□			1	44x67	2632
017				1	44x114	2700
018				16	44x114	2700
019				1	44x114	3900
024				18	44x114	3900
029				17	44x114	1485
030				17	44x114	244
031				17	44x114	485
032				1	44x114	3900

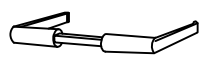
Pos	14.07.2016	Piece list - Stückliste - Liste des pièces Art.Nr. 4419802	8/11	Q.	P (mm)	L (mm)
WA-1				1		
WB-1				1		
WC-1				1		
IAR4		FOUNDATION - FUNDAMENT - FONDATION 		11	45x45	5650
IAR1		FOUNDATION - FUNDAMENT - FONDATION 		2	45x45	3690
IAR3		FOUNDATION - FUNDAMENT - FONDATION 		2	45x45	583
IAR2		FOUNDATION - FUNDAMENT - FONDATION 		2	45x45	496
PR1		ROOF BEAM - DACHBALKEN - PANNE DE TOIT 		1	44x140	6150
A-PR1		ROOF BEAM - DACHBALKEN - PANNE DE TOIT 		2	44x140	6150
		FLOOR BOARDS - FUSSBODENBRETTER - LAME DE PLANCHER 		37	90x18	2408
		FLOOR BOARDS - FUSSBODENBRETTER - LAME DE PLANCHER 		26	90x18	2280
		FLOOR BOARDS - FUSSBODENBRETTER - LAME DE PLANCHER 		26	90x18	1280
		TERRACE BOARDS - TERRASSENBRETTER - PLANCHER DE TERRASSE 		35	90x19	1200
		ROOF BOARDS - DACHBRETTER - VOLIGES 		138	90x18	2200
		FLOOR FILLET - FUSSBODENLEISTE - CORNIERE DE FINITION DU PLANCHER 			18x18	27.84
RFF		ROOFING FELT FILLET - DACHPAPPENLEISTE - BAGUETTE DE FIXATION DU FEUTRE BITUMEUX 		4	18x58	2250
KM1		TREADED ROD M10 - GEWINDESTANGE M10 - TIGE FILETÉE M10 		3		125
KM2		TREADED ROD M10 - GEWINDESTANGE M10 - TIGE FILETÉE M10 		1		340
KM3		TREADED ROD M10 - GEWINDESTANGE M10 - TIGE FILETÉE M10 		4		2000
PL1		FILLE FOR TERRACE RAILING - LEISTE FÜR TERRASSE - BAGUETTE POUR CORPS DE TERRASSE 		4	18x18	1839
PL2		FILLE FOR TERRACE RAILING - LEISTE FÜR TERRASSE - BAGUETTE POUR CORPS DE TERRASSE 		44	28x34	994
PL3		FILLE FOR TERRACE RAILING - LEISTE FÜR TERRASSE - BAGUETTE POUR CORPS DE TERRASSE 		2	18x70	1839

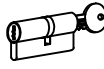
Pos	14.07.2016	Piece list - Stückliste - Liste des pièces Art.Nr. 4419802	9/11	Q.	P (mm)	L (mm)
P2		POST - PFOSTEN - POTEAU 		1	70x70	1839
GL		FASCIA BOARD - TRAUFBRETT - BANDEAU DE TOIT 		4	18x90	3075
		ROOF EDGE REINFORCEMENT - DACHRANDVERSTÄRKUNG - CORNIERE DE RENFORT DE BORD DE TOIT 		4	28x34	3075
		GABLE MOULDING - GIEBELLEISTE - PLANCHE DE RIVE 		4	18x120	2250
		WINDOW HANDLE FITTINGS - FENSTERGRIFF - POIGNÉE D'OUVERTURE DE FENETRE 		2		
		LID FOR TREADED ROD HOLE - ABDECKUNG FÜR GEWINDESTANGENÖFFNUNG - COUVERCLE POUR ACCÈS RÉGLAGÉ TIGE FILETÉE 		1		
		LENGTHENING BOLT FOR TREADED ROD - VERLÄNGERUNGSMUTTER FÜR GEWINDESTANGE - MANCHON DE RACCORDEMENT DE TIGE FILETÉE 		4		
HS104		SCREW FOR SLIDING WALL TIE - SCHIEBEREGLER FÜR WAND - SABOT MÉTALLIQUE POUR FIXATION MUR 		8	3.5x20	
		SCREW FOR GABLE SEGMENT - SCHRAUBEN FÜR DECKBLATT - VIS POUR FIXATION LOSANGE DE FINITION 		4	3.5x35	
		SCREW FOR POST - SCHRAUBEN FÜR PFOSTEN - VIS DE FIXATION DES POTEAUX 		2	3.5x50	
		SCREW FOR GABLE MOULDING - SCHRAUBEN FÜR GIEBELLEISTE - VIS DE FIXATION POUR PLANCHE DE RIVE 		24	3.5x50	
HS1		SCREW FOR COVERING MOULDING - SCHRAUBEN FÜR DECKUNGSPROFIL - VIS DE FIXATION PROFILS DE FINITION VERTICAUX A FIXER A L'EXTERIEUR DU CADRE DE LA PORTE 		20	3x30	
		SCREW FOR DOOR FILLET - SCHRAUBE ZUR BEFESTIGUNG TÜRLEISTE - VIS D'ASSEMBLAGE DU CADRE DE PORTE 		5	3x30	
HS103		LID FOR TREADED ROD HOLE - ABDECKUNG FÜR GEWINDESTANGENÖFFNUNG - COUVERCLE POUR ACCÈS RÉGLAGÉ TIGE FILETÉE 		4	4.5x80	
		SCREW FOR COVERING MOULDING - SCHRAUBEN FÜR DECKUNGSPROFIL - VIS DE FIXATION PROFILS DE FINITION VERTICAUX A FIXER A L'EXTERIEUR DU CADRE DE LA PORTE 		88	4x40	
		SCREW FOR FASCIA BOARDS - SCHRAUBEN FÜR TRAUFBRETT - VIS DE FIXATION POUR BANDEAU DE TOIT 		28	4x40	
		SCREW FOR ROOF EDGE REINFORCEMENT - SCHRAUBEN FÜR DACHRANDVERSTÄRKUNG - VIS POUR RENFORT DE BORD DE TOIT 		28	4x40	
		SCREW FOR ROOF BEAMS - SCHRAUBEN FÜR DACHBALKEN - VIS POUR PANNE DE TOIT 		15	5x120	
		SCREW FOR GABLE - SCHRAUBEN FÜR GIEBEL - VIS POUR FIXATION DES PIGNONS 		16	5x120	
		SCREW FOR 1. WALL BEAM - SCHRAUBE FÜR 1. BOHLENREIHE - VIS DE FIXATIONS 1ÈRE RANGÉE DE MADRIERS AVEC POUTRELLES DE FONDATIONS 		11	5x90	
		SCREW FOR FOUNDATION - SCHRAUBEN ZUR BEFESTIGUNG FUNDAMENT - VIS DE FIXATIONS DES POUTRELLES DE FONDATIONS 		55	5x90	
		SCREW FOR DOOR JAMB - SCHRAUBE FÜR TÜRRAHMEN - VIS DE FIXATION POUR MONTANT DE PORTE 		4	5x90	
HS72		SCREW FOR SLIDING WALL TIE - SCHIEBEREGLER FÜR WAND - SABOT MÉTALLIQUE POUR FIXATION MUR 		2	6x40	
		SCREW FOR POST HEIGHT ADJUSTMENT - SCHRAUBEN FÜR REGULIERUNGSSCHRAUBE FÜR PFOSTEN - VIS DE FIXATION DE 		8	6x50	
		SCREW FOR DOORSTEP - SCHRAUBEN FÜR SWELLE - VIS DE FIXATION DU SEUIL DE PORTE 		7	4.5x65	

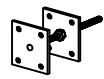
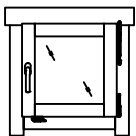
Pos	14.07.2016	Piece list - Stückliste - Liste des pièces Art.Nr. 4419802	10/11	Q.	P (mm)	L (mm)
		ZN NAIL FOR FLOOR FILLET - ZN NÄGEL FÜR FUSSBODENLEISTE - POINTE POUR CORNIERE DE FINITION DU PLANCHER		57	1.4x40	
		HAMMER BLOCK - SCHLAGHOLZ - CALLE DE FRAPPE		1		
		DRIVE NUT TREADED ROD - EINSHLAGMUTTER FÜR GEWINDESTANGE - ÉCROU A FRAPPER POUR TIGE FILITÉE		4		
		NUT FOR TREADED ROD - MUTTER FÜR GEWINDESTANGE - ÉCROU POUR TIGE FILETÉE		4		
		ZN NAIL FOR TERRACE - ZN NÄGEL FÜR TERRASSENBRETT - POINTE POUR PLANCHER DE TERRASSE		210	2.1x50	
		ZN NAIL FOR ROOF - ZN NÄGEL FÜR DACHBRETT - POINTES DE FIXATIONS DES VOLIGES DE TOIT		472	2x50	
		ZN NAIL FOR FLOOR - ZN NÄGEL FÜR FUSSBODENBRETT - CLOUS POUR PLANCHER		406	2x50	
		ZN NAIL FOR ROOFING FELT FILLET - ZN NÄGEL FÜR DACHPAPPENLEISTE - POINTE POUR BAGUETTE FIXATION FEUTRE BITUMEUX		24	2x40	
GS		GABLE SEGMENT - DECKBLATT - LOSANGE DE FINITION		2		
		PLAIN WASHER TREADED ROD - UNTERLEGSCHIEBE FÜR GEWINDESTANGE - RONDELLE PLATE POUR TIGE FILETÉE		4		
SB		PLAIN WASHER - UNTERLEGSCHIEBE - RONDELLE PLATE		2		
		SLIDING WALL TIE - SCHIEBEREGLER FÜR WAND - SABOT MÉTALLIQUE POUR FIXATION MUR		2		
		DOOR HANDLE FITTINGS - TÜRGRIF - SET DE GARNITURES DE SERRURE DE PORTE		3		
		SET OF DOOR LOCK COVERS - SCHLOSSBLENDE - SET DE GARNITURES DE SERRURE DE PORTE		3		
		CYLINDER LOCK - ZYLINDERSCHLOSS - CYLINDRE DE SERRURE		3	30x35	
		MALE BOLT HINGE FOR DOOR - TÜRRIEGEL - PARTIE MALE DE CHARNIERE DE PORTE		6		
RFP		POST HEIGHT ADJUSTMENT - REGULIERUNGSSCHRAUBE FÜR PFOSTEN - SUPPORT RÉGLABLE DE POTEAU		1		
		WINDOW - FENSTER - FENETRE 540x540 AK.1.100.PSP.a DGP+		2		

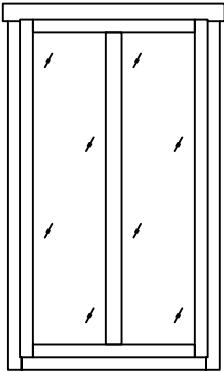
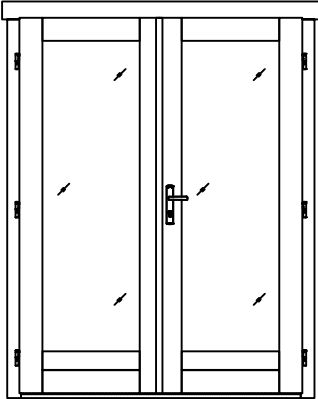
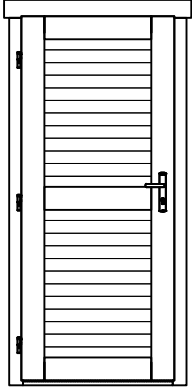
Pos	14.07.2016 Piece list - Stückliste - Liste des pièces Art.Nr. 4419802	11/11	Q.	P (mm)	L (mm)
	WINDOW - FENSTER - FENETRE 1010x1780 TAK.1.100.PM0.e DGP+ 		1		
	DOOR - TÜR - PORTE 1494x1957 TUK.1.100.PVP.MMb DGP+ 		1		
	DOOR - TÜR - PORTE 835x1900 UL.2.100.IVV.MMd TP+ 		2		