

*Java*  
*Art. Nr. 4415802*  
*1/12*

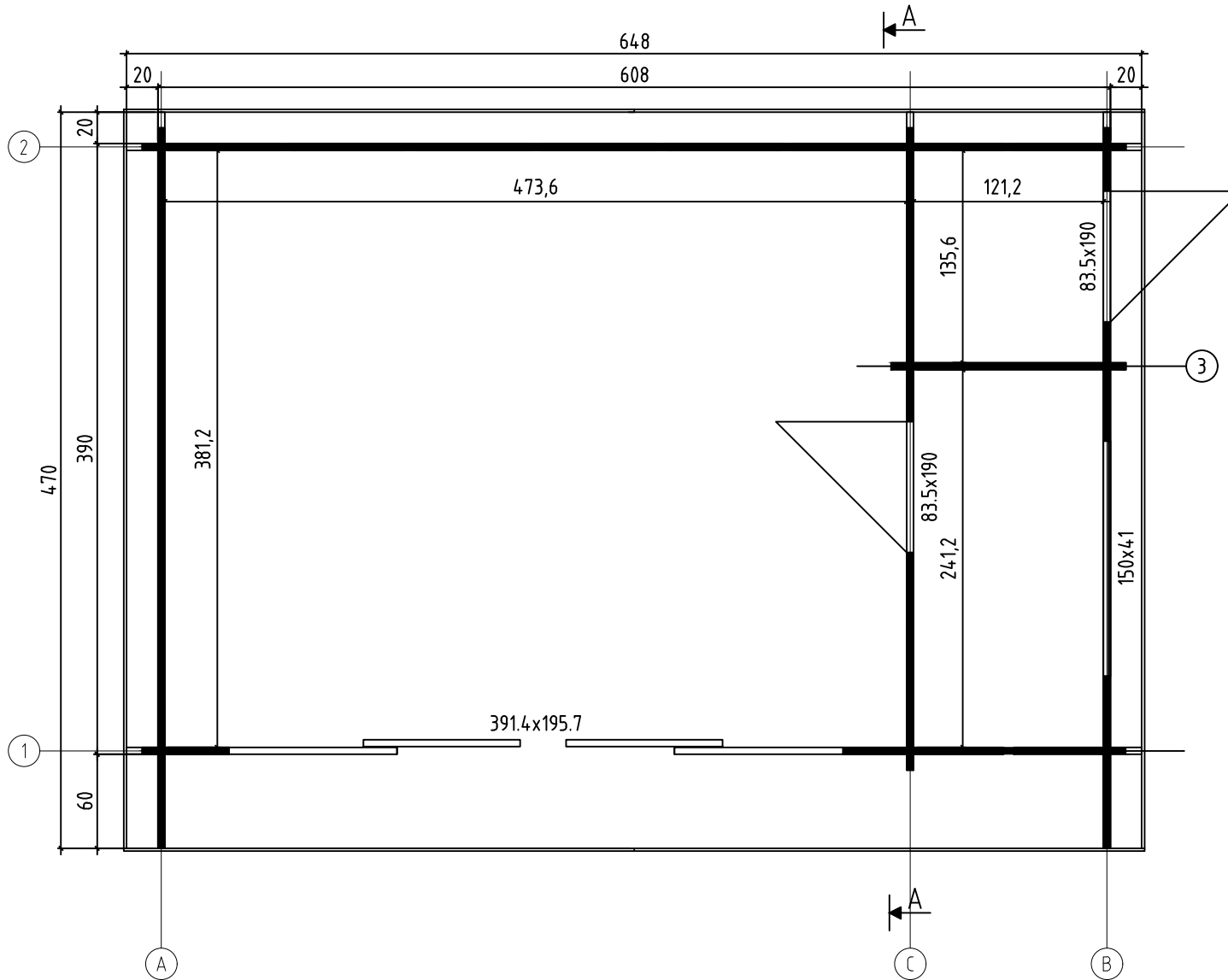

Art.Nr. 4415802

GROUNDPLAN - GRUNDPLAN - PLAN DE MASSE



FOUNDATION - FUNDAMENT - FONDATION

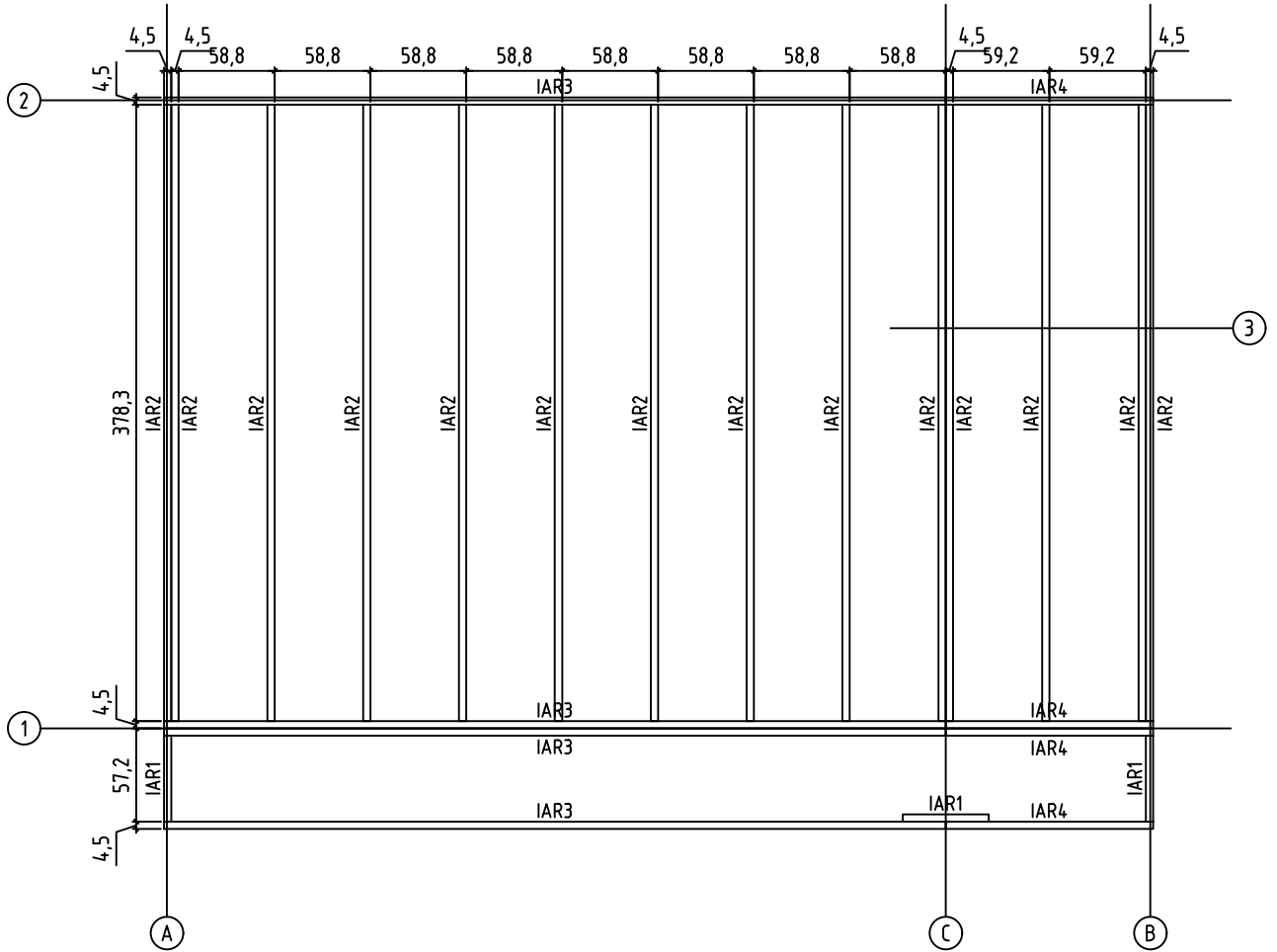

FLOOR BOARDS - FUSSBODENBRETTNER - LAME DE PLANCHER  
TERRACE BOARDS - TERRASSENBRETTNER - PLANCHER DE TERRASSE

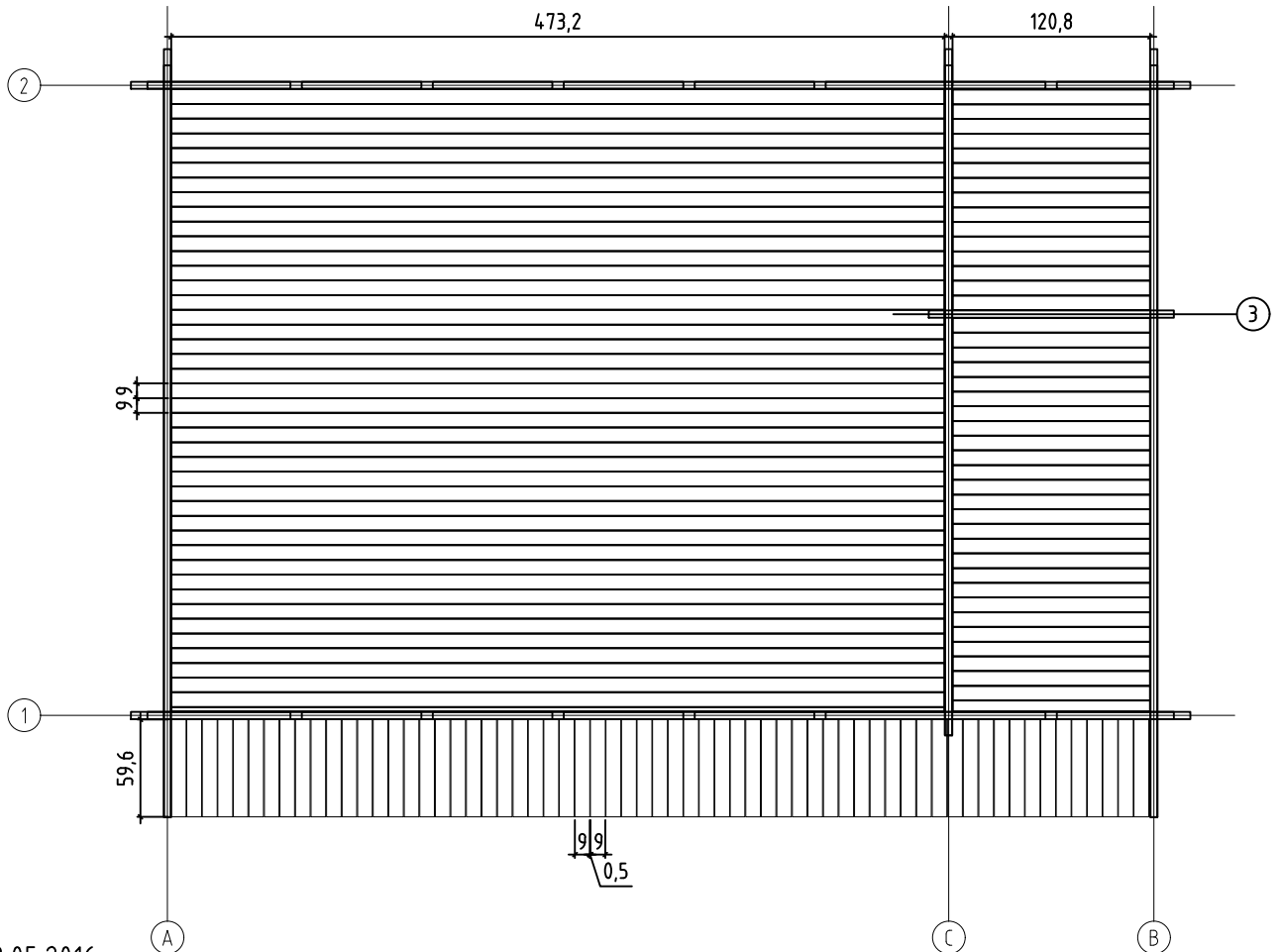

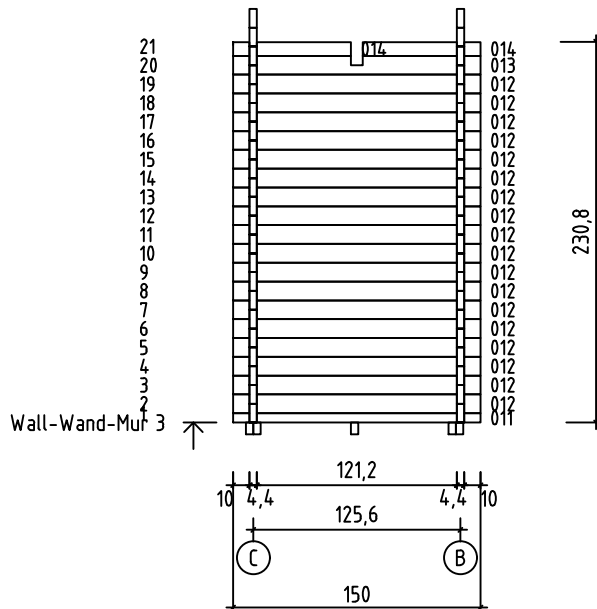
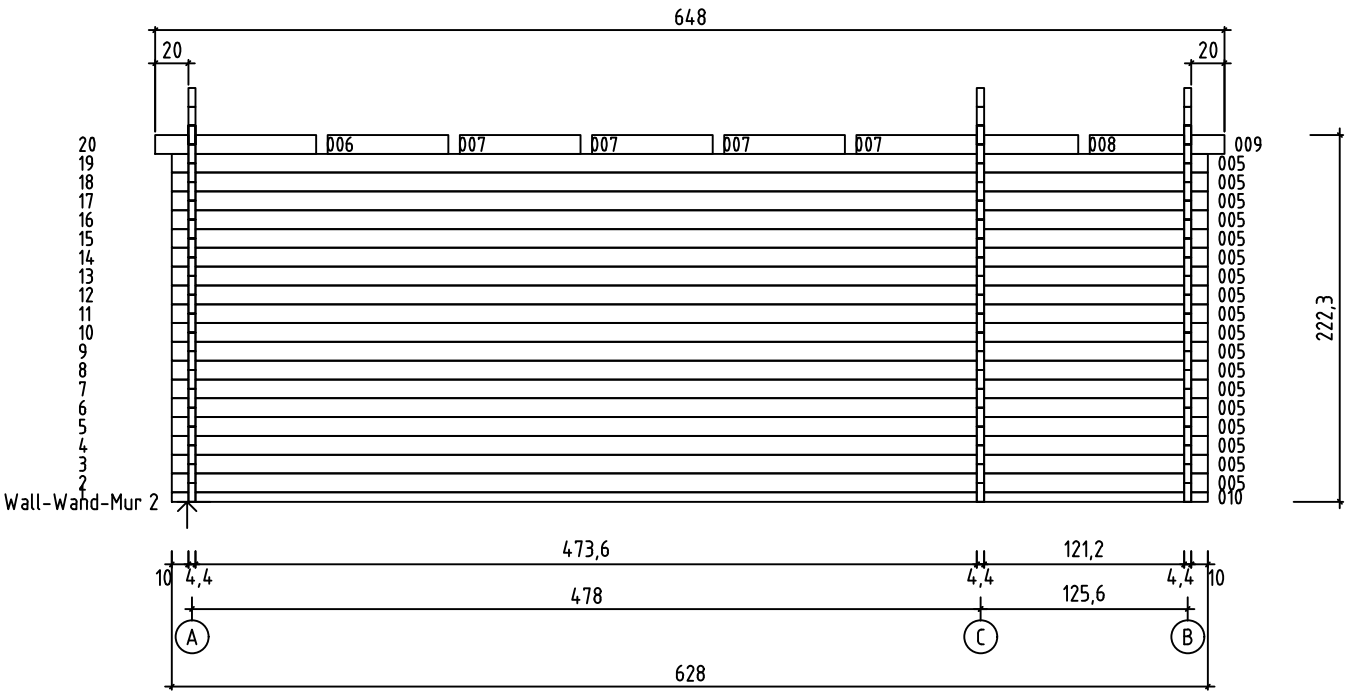
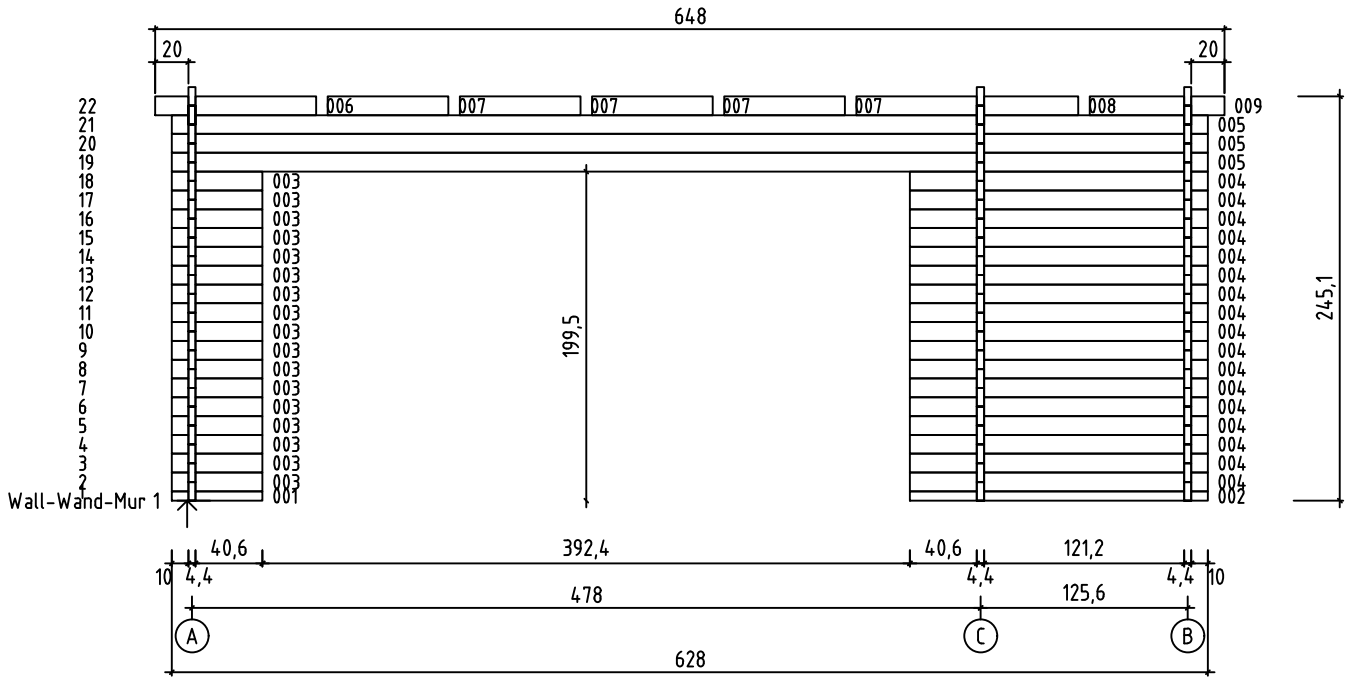

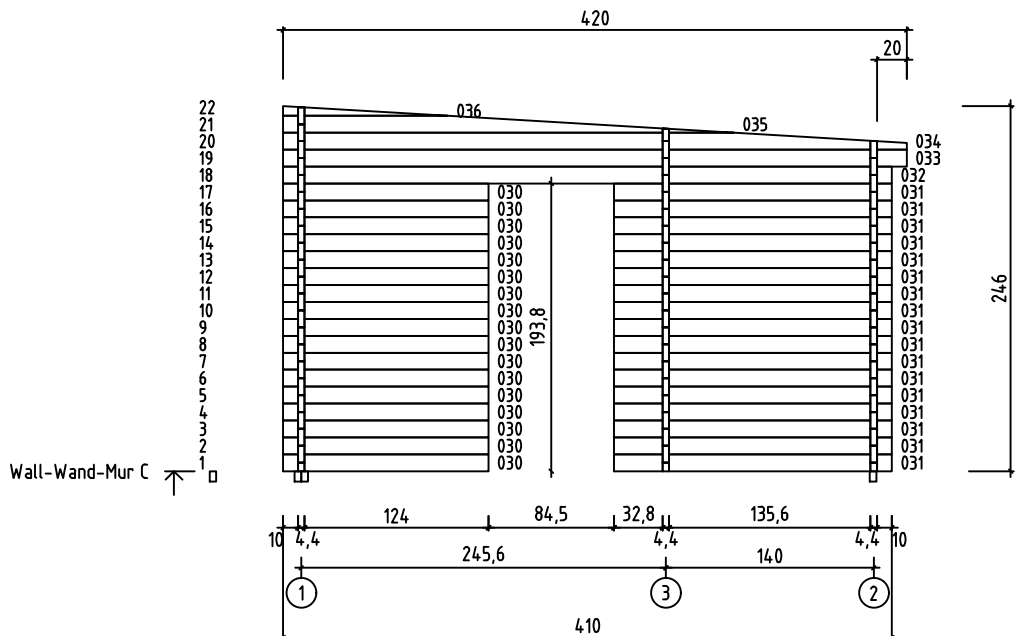
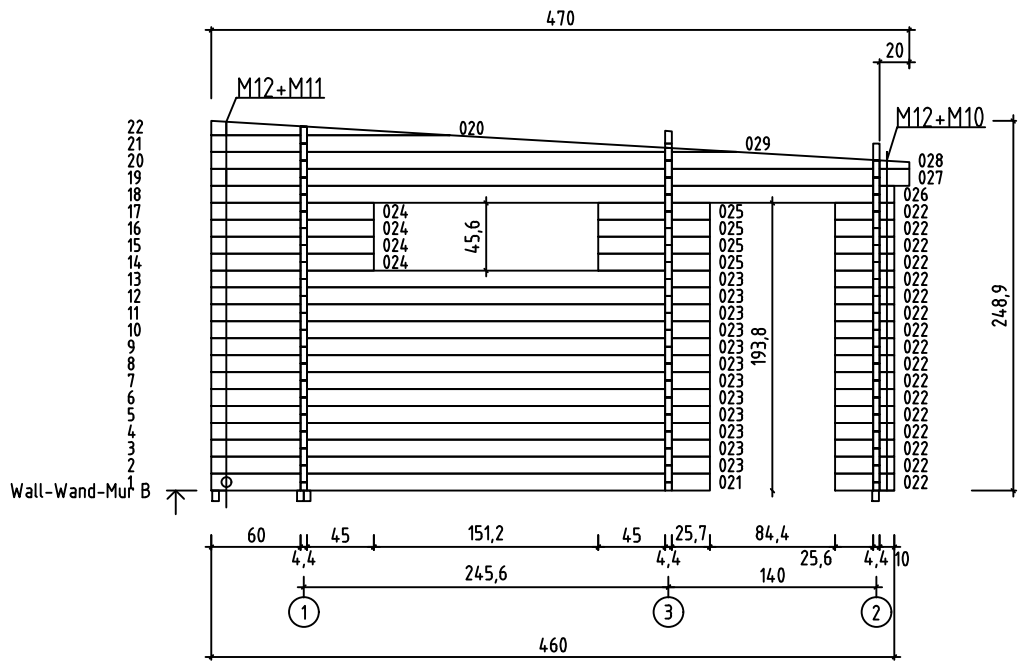
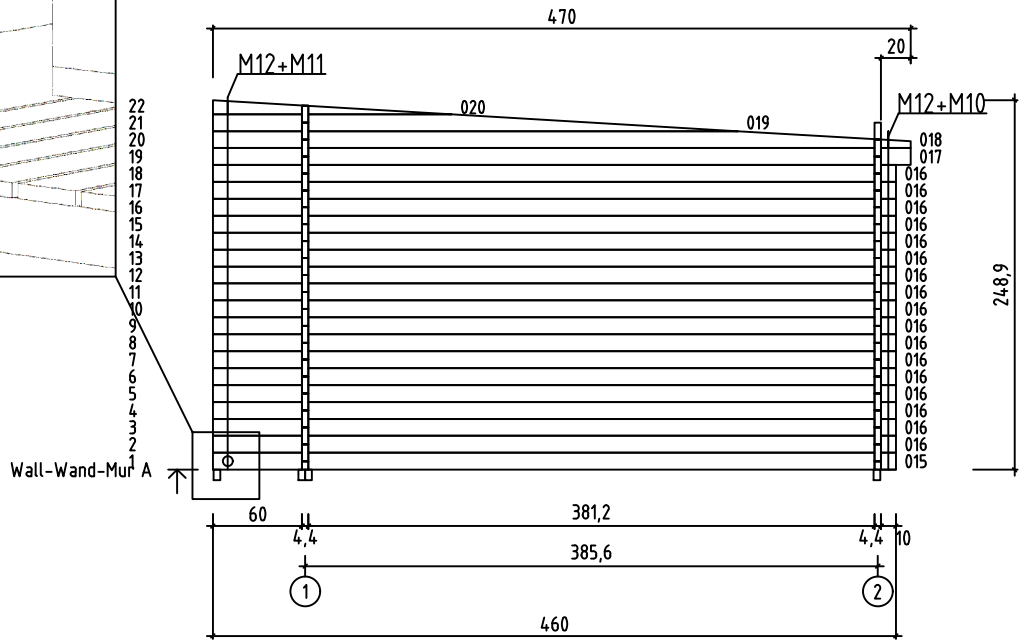
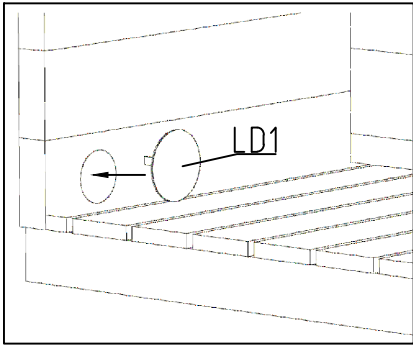

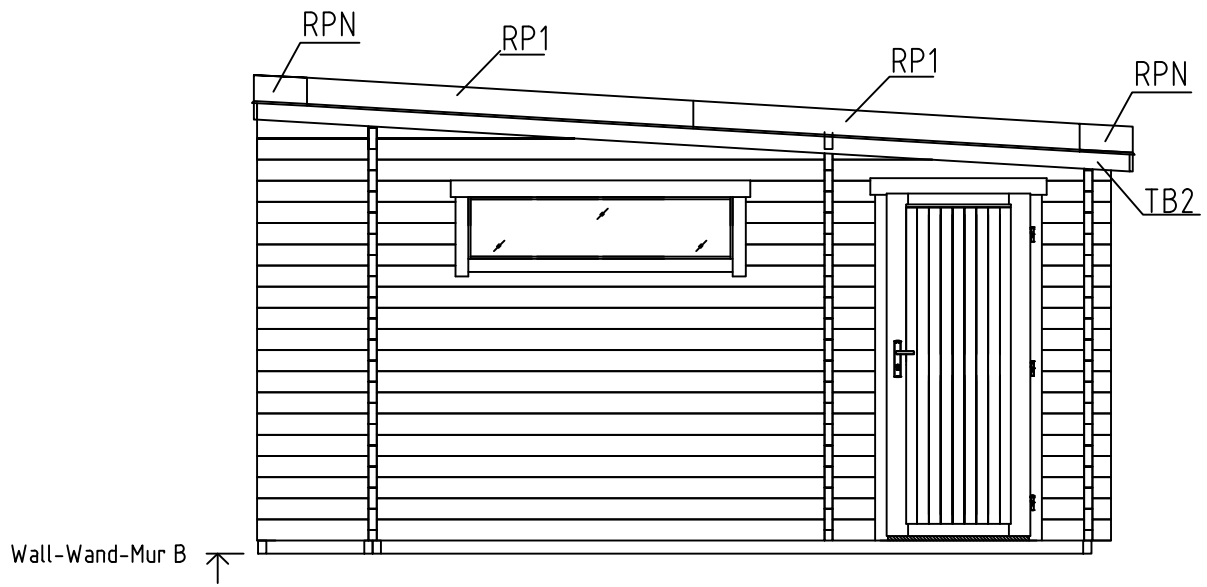
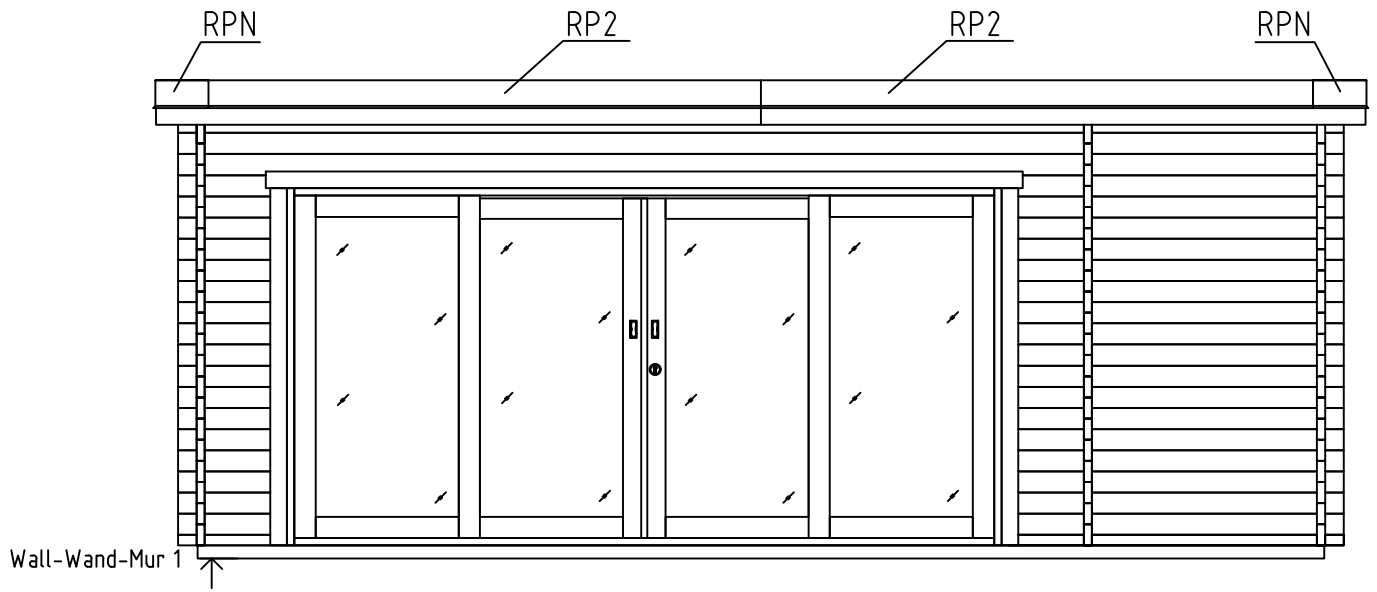



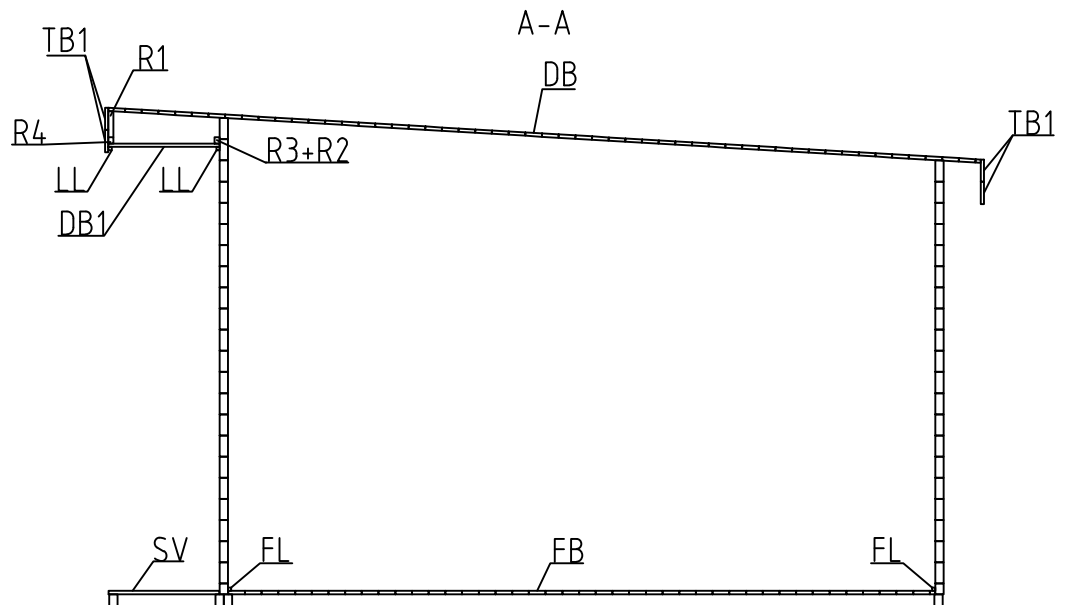



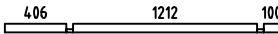

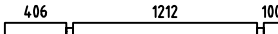
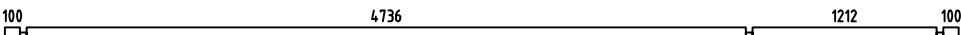
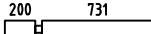
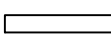
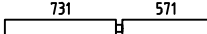
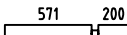

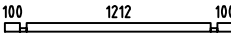
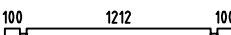
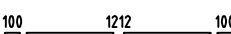
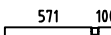
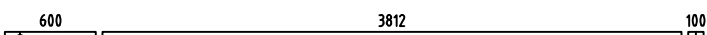

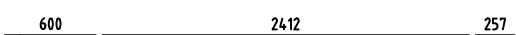

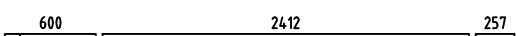
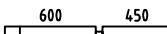
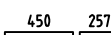

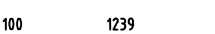

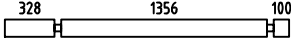
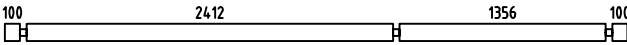
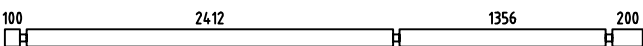
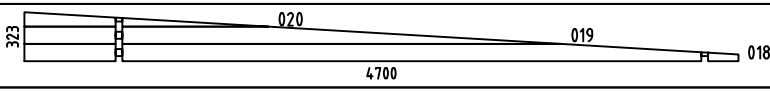
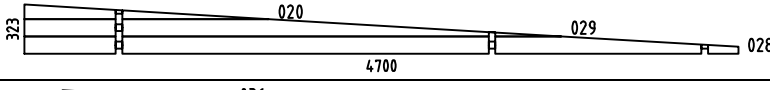
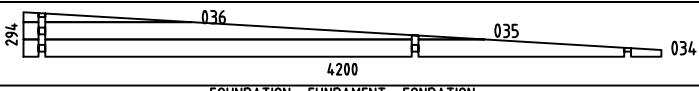

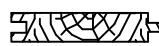

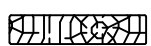

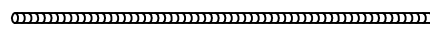
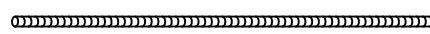
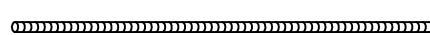







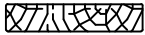
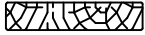





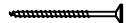
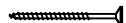

CROSS SECTION - SCHNITT - VU DE COUPE

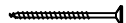
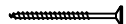
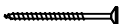
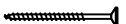

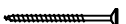







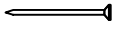
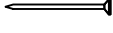

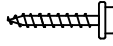

Pos	03.05.2016	Piece list - Stückliste - Liste des pièces Art.Nr. 4415802	7/12	Q.	P (mm)	L (mm)
001				1	44x57	550
002				1	44x57	1806
003				17	44x114	550
004				17	44x114	1806
005				21	44x114	6280
006				2	44x114	975
007				8	44x114	731
008				2	44x114	1346
009				2	44x114	815
010				1	44x57	6280
011				1	44x57	1500
012				18	44x114	1500
013				1	44x114	1500
014				2	44x83	715
015				1	44x114	4600
016				17	44x114	4600
017				1	44x114	4700
021				1	44x114	3357
022				17	44x114	399
023				12	44x114	3357
024				4	44x114	1094
025				4	44x114	751
026				1	44x114	4600
027				1	44x114	4700
030				17	44x114	1383

Pos	03.05.2016	Piece list - Stückliste - Liste des pièces Art.Nr. 4415802	8/12	Q.	P (mm)	L (mm)
031				17	44x114	1872
032				1	44x114	4100
033				1	44x114	4200
WA-1				1		
WB-1				1		
WC-1				1		
IAR3	FOUNDATION - FUNDAMENT - FONDATION			4	45x70	4797
IAR2	FOUNDATION - FUNDAMENT - FONDATION			14	45x70	3783
IAR4	FOUNDATION - FUNDAMENT - FONDATION			4	45x70	1273
IAR1	FOUNDATION - FUNDAMENT - FONDATION			3	45x70	527
SR1	RAFTER - DACHSPARREN - CHEVRON			6	70x140	4717
FB	FLOOR BOARDS - FUSSBODENBRETTER - LAME DE PLANCHER		43	90x18	4732	
FB	FLOOR BOARDS - FUSSBODENBRETTER - LAME DE PLANCHER		43	90x18	1208	
DB2	ROOF BOARDS - DACHBRETTER - VOLIGES		53	90x18	3413	
DB3	ROOF BOARDS - DACHBRETTER - VOLIGES		53	90x18	3067	
DB1	ROOF BOARDS - DACHBRETTER - VOLIGES		67	90x18	596	
SV	TERRACE BOARDS - TERRASSENBRETTER - PLANCHER DE TERRASSE		64	90x19	596	
LL	CEILING FILLET - DECKELEISTE - PROFIL DE FINITION SOUS PLAFOND			18x18	13.17	
FL	FLOOR FILLET-FUSSBODENLEISTE - CORNIERE DE FINITION DU PLANCHER			18x18	29.43	
M10	TREADED ROD M10 - GEWINDESTANGE M10 - TIGE FILETÉE M10		2		250	
M11	TREADED ROD M10 - GEWINDESTANGE M10 - TIGE FILETÉE M10		2		450	
M12	TREADED ROD M10 - GEWINDESTANGE M10 - TIGE FILETÉE M10		4		2000	
R1	LATH - PFETTEN - LITEAU		2	28x34	140	
R2	LATH - PFETTEN - LITEAU		2	28x34	570	
R3	LATH - PFETTEN - LITEAU		6	28x34	730	

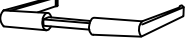

Pos	03.05.2016	Piece list - Stückliste - Liste des pièces Art.Nr. 4415802	9/12	Q.	P (mm)	L (mm)
R4	LATH - PFETTEN - LITEAU		2	28x34	2996	
TB1	EAVES BOARD - TRAUFBRETT - BANDEAU DE TOIT		8	18x120	3258	
TB2	EAVES BOARD - TRAUFBRETT - BANDEAU DE TOIT		4	18x120	4715	
RP1	EAVES SHEET - ABSCHLUSSPROFIL - PROFIL DE FINITION MÉTALLIQUE POUR DÉBORD DE TOITURE		4		2200	
RP2	EAVES SHEET - ABSCHLUSSPROFIL - PROFIL DE FINITION MÉTALLIQUE POUR DÉBORD DE TOITURE		4		3100	
LD1	LID FOR TREADED ROD HOLE - ABDECKUNG FÜR GEWINDESTANGENÖFFNUNG - COUVERCLE POUR ACCÈS RÉGLAGÉ TIGE FILETÉE		2			
	LENGTHENING BOLT FOR TREADED ROD - VERLÄNGERUNGSMUTTER FÜR GEWINDESTANGE - MANCHON DE RACCORDEMENT DE TIGE FILETÉE		4			
	DRIVE NUT TREADED ROD - EINSHLAGMUTTER FÜR GEWINDESTANGE - ÉCROU A FRAPPER POUR TIGE FILITÉE		4			
	NUT FOR TREADED ROD - MUTTER FÜR GEWINDESTANGE - ÉCROU POUR TIGE FILETÉE		4			
	PLAIN WASHER TREADED ROD - UNTERLEGSCHIEBE FÜR GEWINDESTANGE - RONDELLE PLATE POUR TIGE FILETÉE		4			
	SCREW FOR LOCK COVERS - SCHRAUBE FÜR SCHLOSSBLENDEN VIS POUR SET DE GARNITURES DE SERRURE DE PORTE		4	3.5x15		
	SCREW FOR DOOR HANDLE FITTINGS - SCHRAUBE FÜR TÜRGRIF - VIS POUR SET DE GARNITURES DE SERRURE DE PORTE		16	3x30		
	SCREW FOR SLIDING DOOR ROLLER- SCHRAUBE FÜR SCHIEBETÜR LAUFRAD - VIS POUR FERRURE DE PORTE COULISSANTE		8	3x30		
	SCREW FOR DOOR FILLET - SCHRAUBE ZUR BEFESTIGUNG TÜRLEISTE - VIS D'ASSEMBLAGE DU CADRE DE PORTE		5	3x30		
	SCREW FOR ROOF LATH - SCHRAUBE FÜR DACHLATTE - VIS POUR LATTE		33	4x40		
	SCREW FOR EAVES BOARDS - SCHRAUBEN FÜR TRAUFBRETT - VIS DE FIXATION POUR BANDEAU DE TOIT		106	4x40		
	SCREW FOR ROOF BEAMS - SCHRAUBEN FÜR DACHBALKEN - VIS POUR PANNE DE TOIT		18	5x120		
HS1	SCREW FOR DOOR JAMB - SCHRAUBE FÜR TÜRRAHMEN - VIS DE FIXATION POUR MONTANT DE PORTE		4	5x120		
	SCREW FOR GABLE - SCHRAUBEN FÜR GIEBEL - VIS POUR FIXATION DES PIGNONS		18	5x120		
	SCREW FOR 1. WALL BEAM - SCHRAUBE FÜR 1. BOHLENREIHE - VIS DE FIXATION DES FONDATIONS		12	5x90		
	SCREW FOR FUNDAMENT - SCHRAUBEN ZUR BEFESTIGUNG FUNDAMENT - VIS POUR FONDATION		54	5x90		
HS2	SCREW FOR DOOR JAMB - SCHRAUBE FÜR TÜRRAHMEN - VIS DE FIXATION POUR MONTANT DE PORTE		4	5x90		
HS3	SCREW FOR FIXING DOOR - SCHRAUBE FÜR BEFESTIGUNG TÜR- VIS POUR FIXATION DE PORTE		16	5x90		
	SCREW FOR DET 006,007,008,009 - SCHRAUBE FÜR DET 006,007,008,009 - VIS POUR DET 006,007,008,009		28	6x180		
	ZN NAIL FOR TERRACE - ZN NÄGEL FÜR TERRASSENRETT - POINTE POUR PLANCHER DE TERRASSE		260	2.1x50		

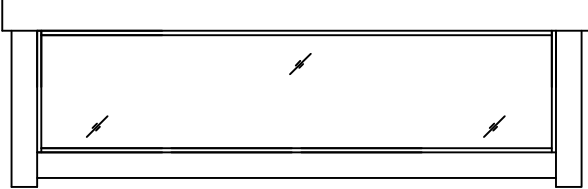
Pos	03.05.2016	Piece list - Stückliste - Liste des pièces Art.Nr. 4415802	10/12	Q.	P (mm)	L (mm)
		ZN NAIL FOR CEILING FILLET - ZN NÄGEL DECKELEISTE - POINTE POUR PROFIL DE FINITION SOUS PLAFOND		27	1.4x40	
		ZN NAIL FOR FLOOR FILLET - ZN NÄGEL FÜR FUSSBODENLEISTE - POINTE POUR CORNIERE DE FINITION DU PLANCHER		60	1.4x40	
		HAMMER BLOCK - SCHLAGHOLZ - CALLE DE FRAPPE		1		
		DOOR HANDLE FITTINGS - TÜRGRIFF - SET DE GARNITURES DE SERRURE DE PORTE		4		
		CYLINDER - ZYLINDERSCHLOSS - CYLINDRE DE SERRURE		1		
		ROLLER FOR SLIDING DOOR - LAUFRAD FÜR SCHIEBETÜR - FERRURE POUR PORTE COULISSANTE		4		
		SET OF DOOR LOCK COVERS - SCHLOSSBLENDEN - SET DE GARNITURES DE SERRURE DE PORTE		2		
		SCREW FOR DOORSTEP - SCHRAUBEN FÜR TÜRSCHWELLE - VIS DE FIXATION DU SEUIL DE PORTE		4	4.5x65	
		SCREW FOR EAVES SHEET - SCHRAUBE FÜR ABSCHLUSSPROFIL - VIS POUR PROFIL DE FINITION MÉTALLIQUE POUR DÉBORD DE TOITURE		56	4.8x28	
RPN		EAVES SHEET CORNER - ECKPROFIL- PROFIL D'HABILLAGE DE RIVES		4		
		ZN NAIL FOR ROOF - ZN NÄGEL FÜR DACHBRETTER - POINTE POUR TOIT		888	2x50	
		ZN NAIL FOR FLOOR - ZN NÄGEL FÜR FUSSBODENBRETTER - CLOUS POUR PLANCHER		528	2x50	
		DOOR HANDLE FITTINGS-TÜRGRIFF - SET DE GARNITURES DE SERRURE DE PORTE		2		
		SET OF DOOR LOCK COVERS - SCHLOSSBLENDEN - SET DE GARNITURES DE SERRURE DE PORTE		2		
		CYLINDER - ZYLINDERSCHLOSS - CYLINDRE DE SERRURE		2	30x35	
		WINDOW - FENSTER - FENETRE 1500x410      AK.1.100.PMO.k	DGP	1		
						

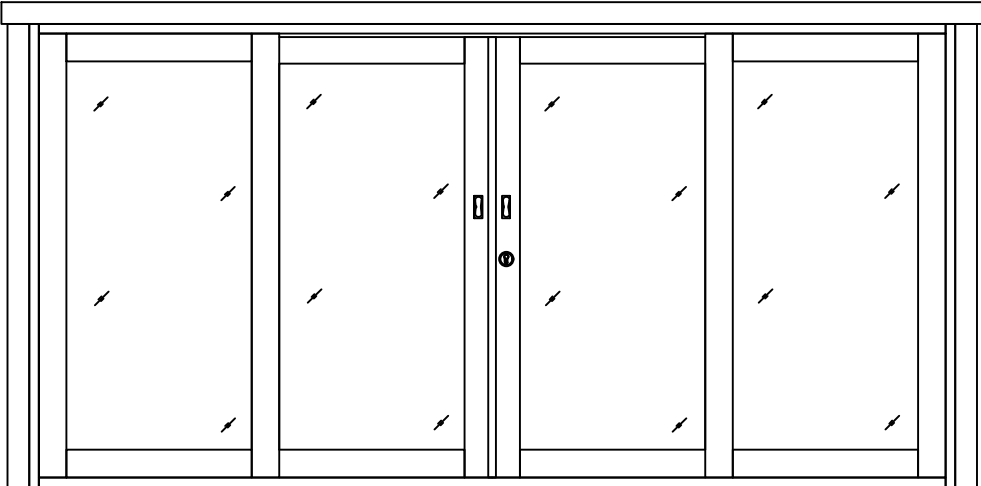
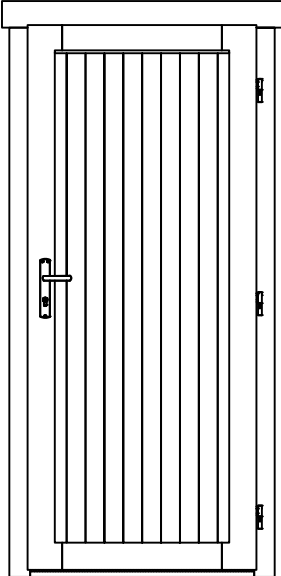
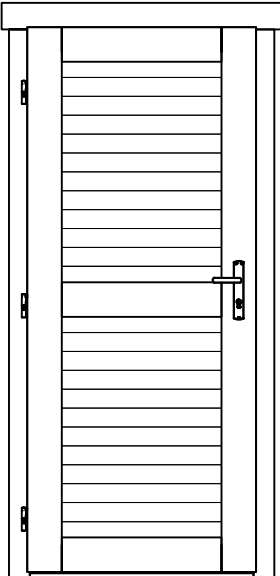
Pos	03.05.2016 Piece list - Stückliste - Liste des pièces Art.Nr. 4415802	11/12	Q.	P (mm)	L (mm)
	DOOR - TÜR - PORTE 3914x1957 TUK.1100.PLP.MMf DGP 	1			
	DOOR - TÜR - PORTE 835x1900 UL.2.100.IVP.MMWd TP+ 	1			
	DOOR - TÜR - PORTE 835x1900 UL.2.100.IVV.MMd TP+ 	1			

1

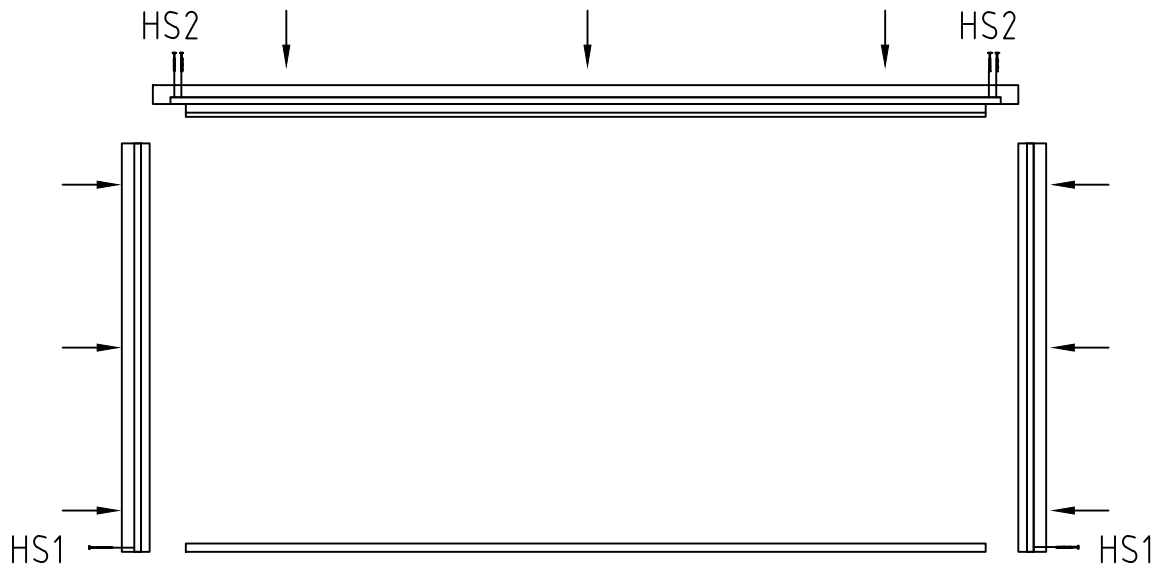

2

