

ORKNEY 1
Art.Nr. 704102

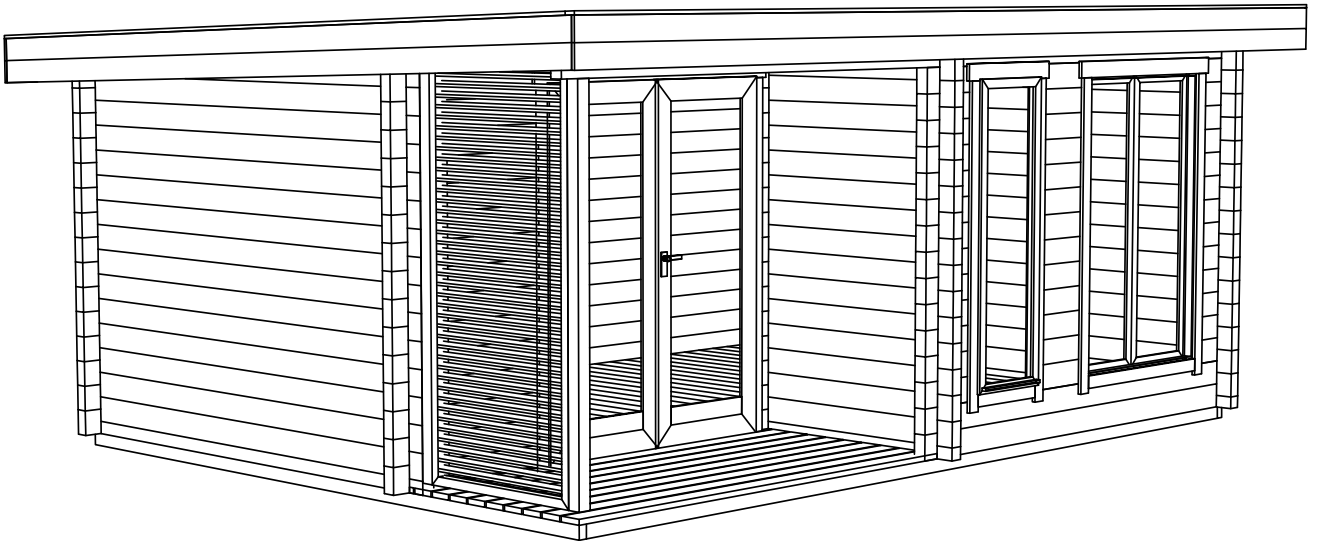

ART.NR. 704102
 GRUNDPLAN - GRUNDPLAN - PLAN DE MASSE

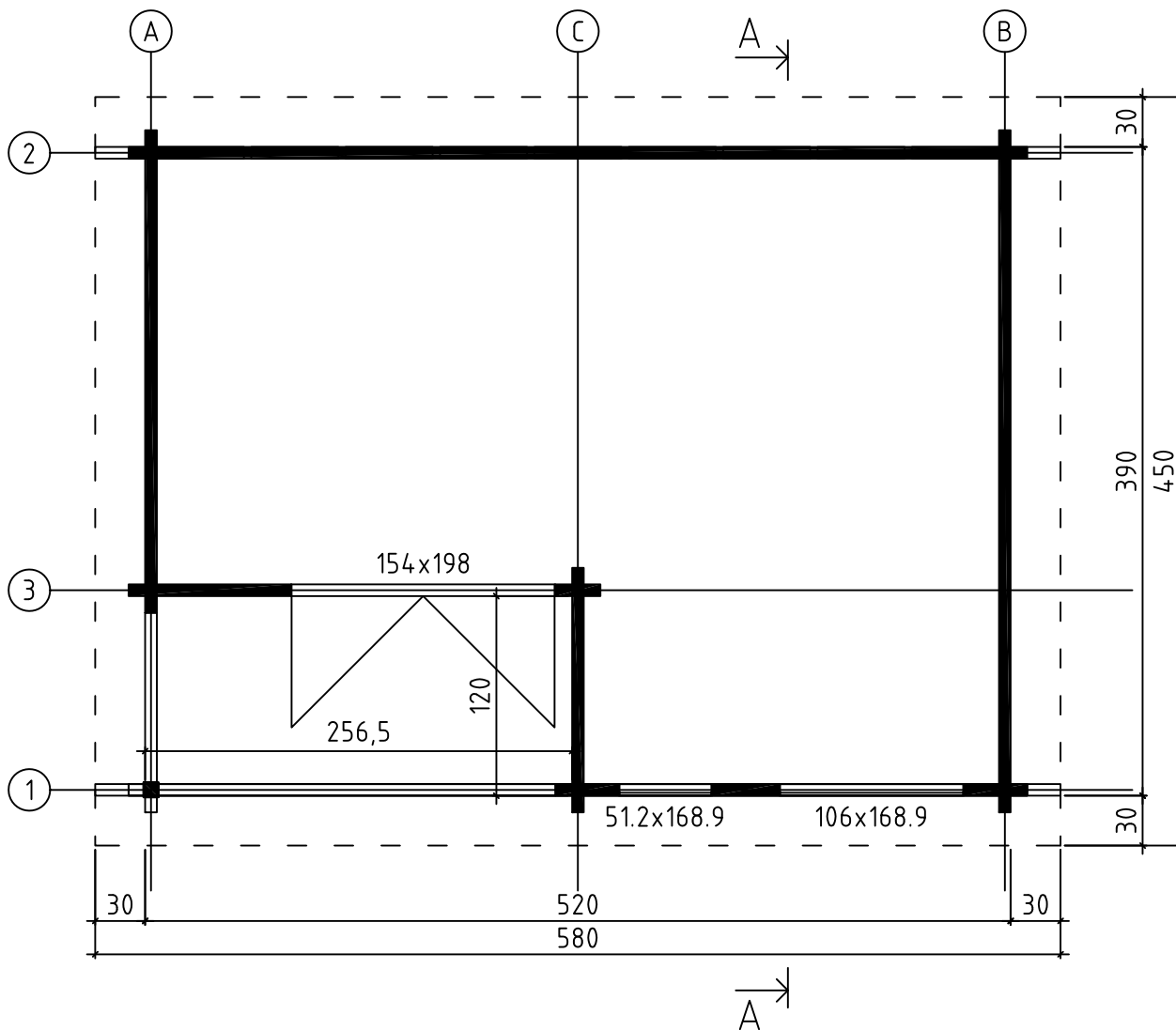

FOUNDATION - FUNDAMENT - FONDATION

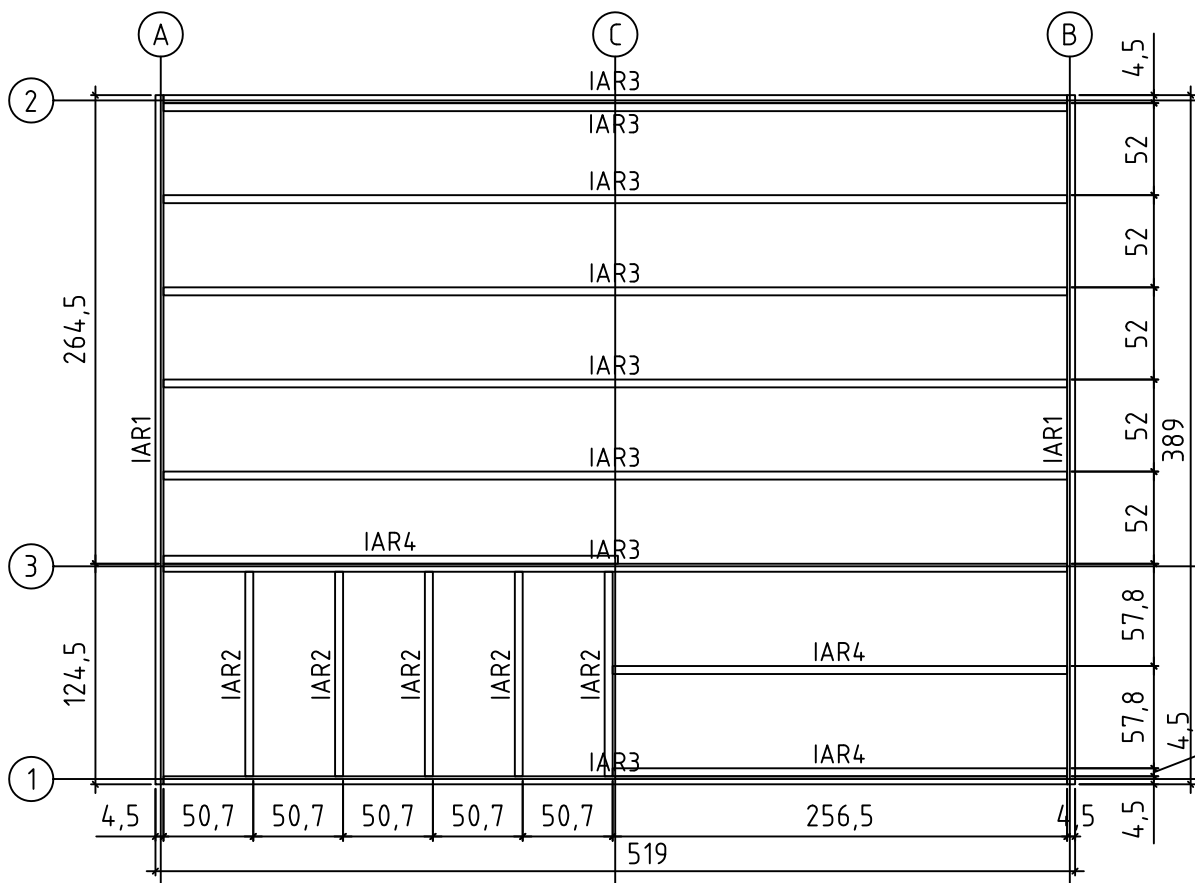

ART.NR. 704102
RAFTERS PLAN - DACHSPARREN - PLAN DE CHEVRON

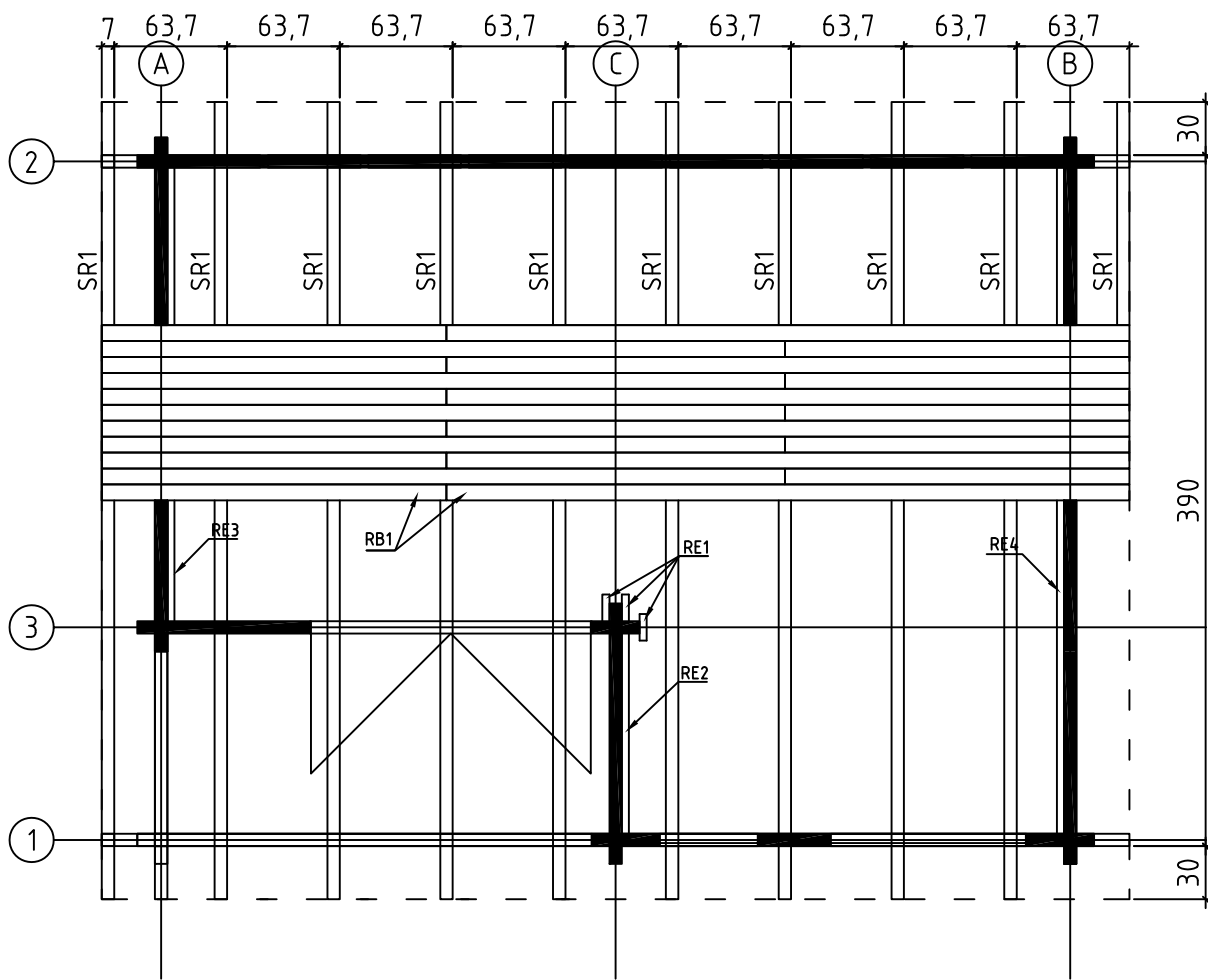

FLOOR BOARDS - FUSSBODENBRETTER - PLAN POSE PLANCHER

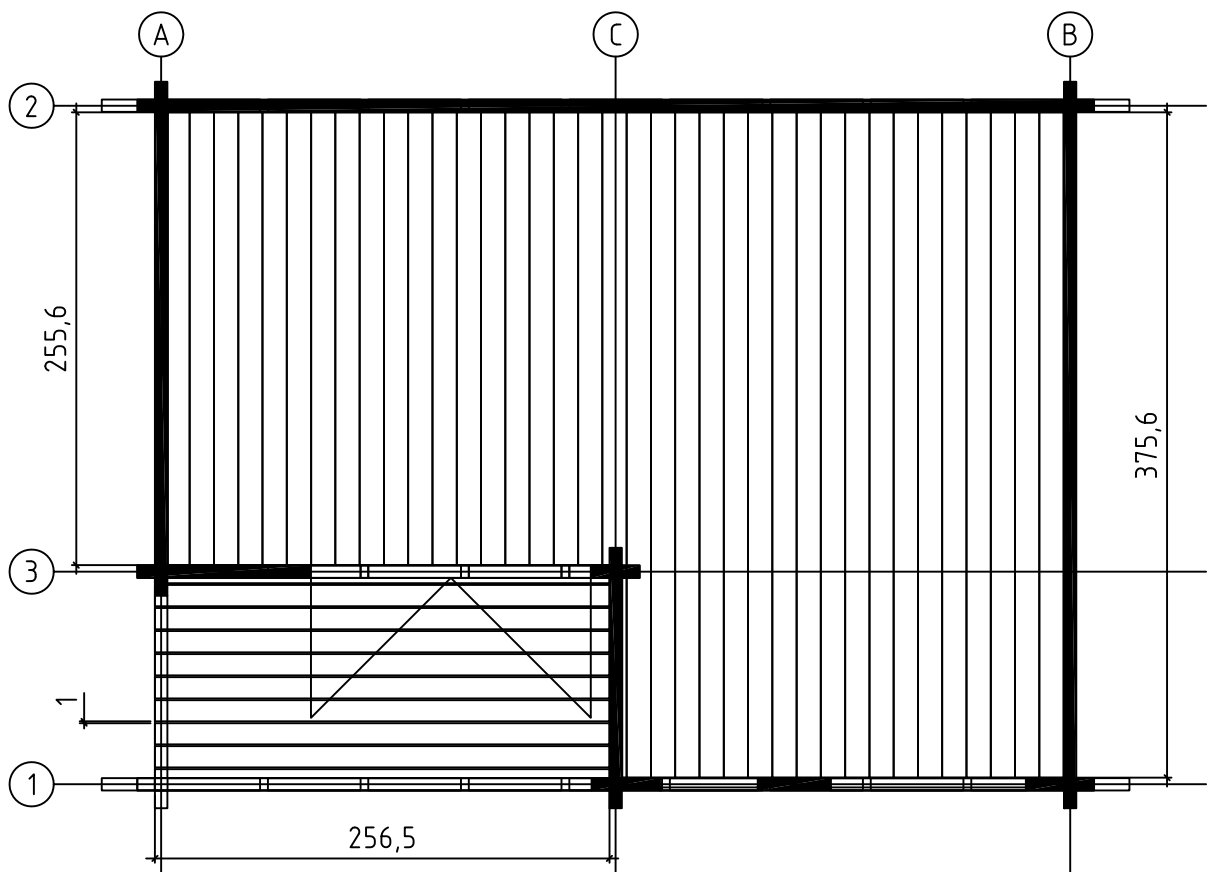

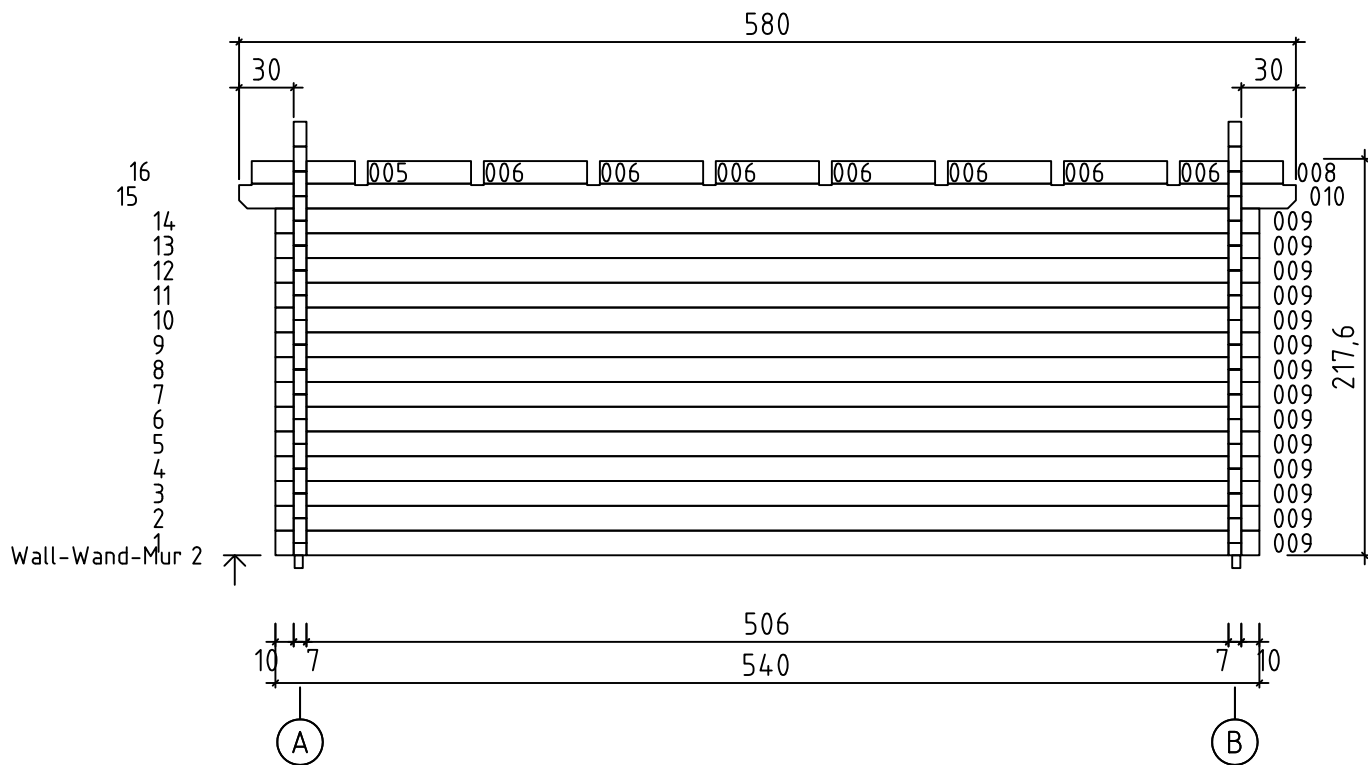
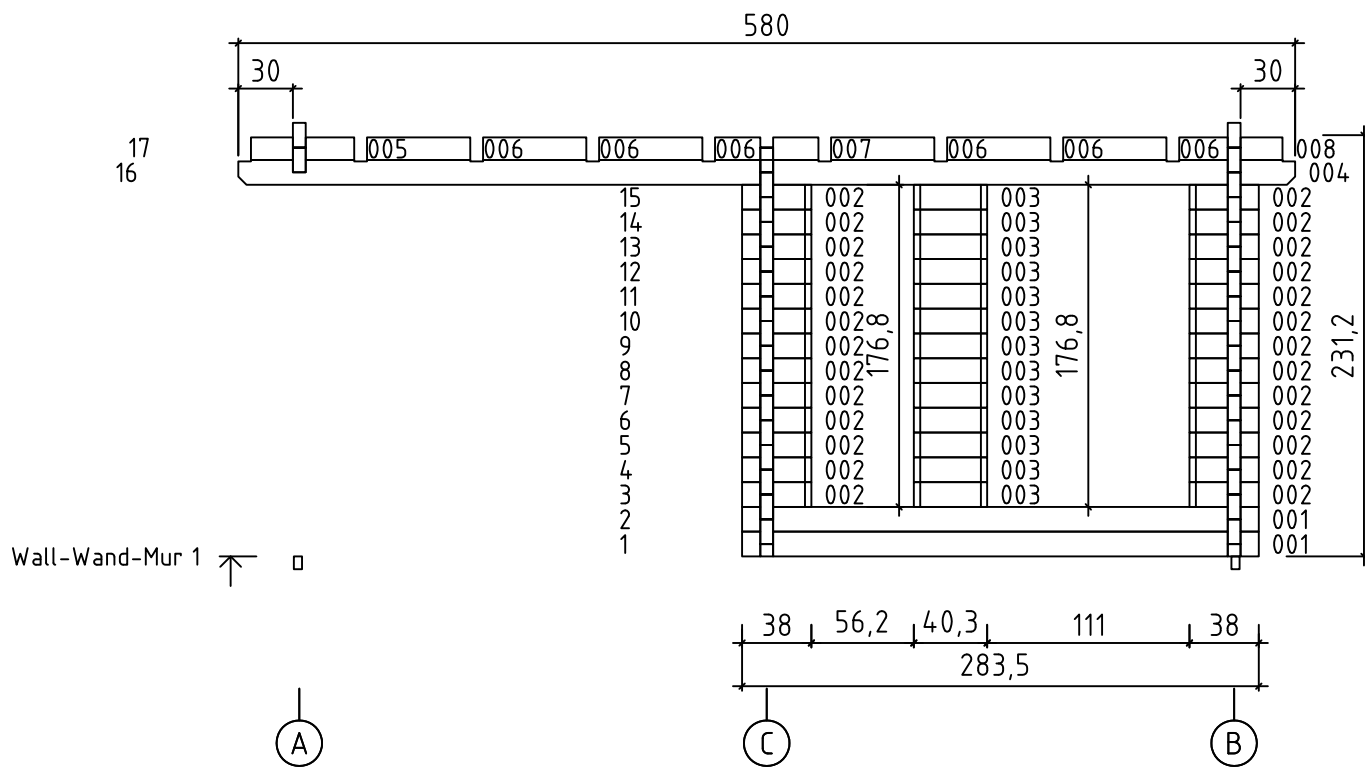

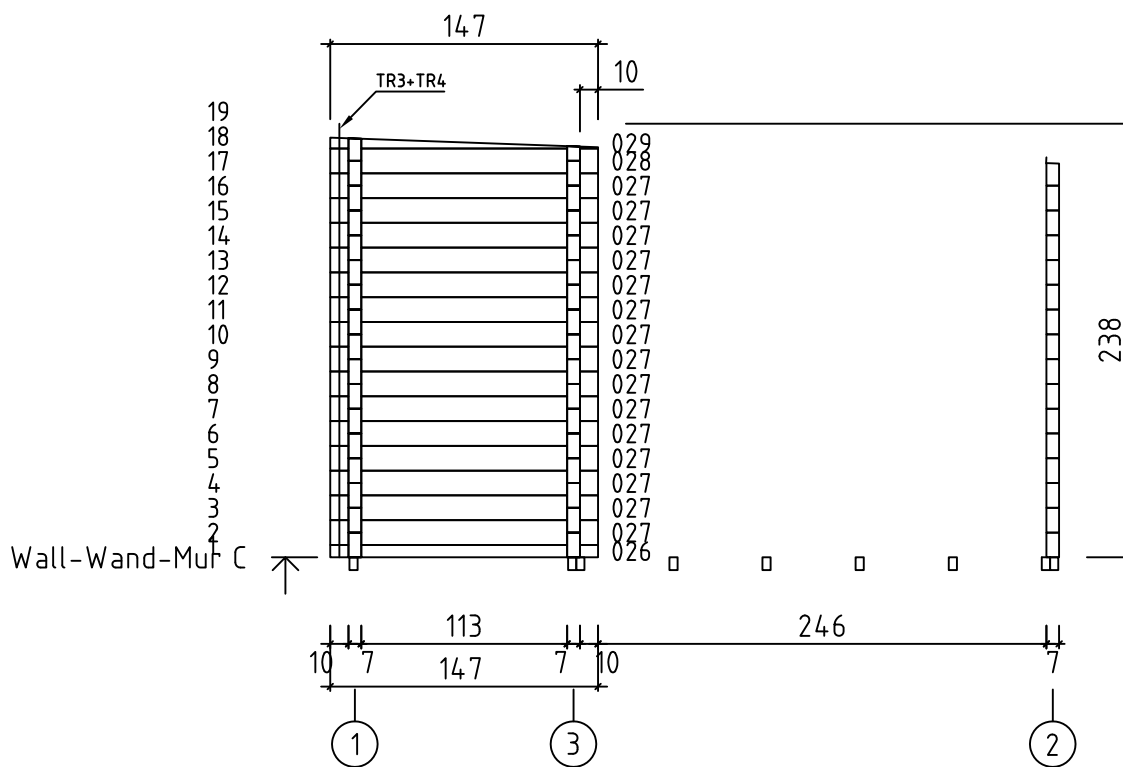
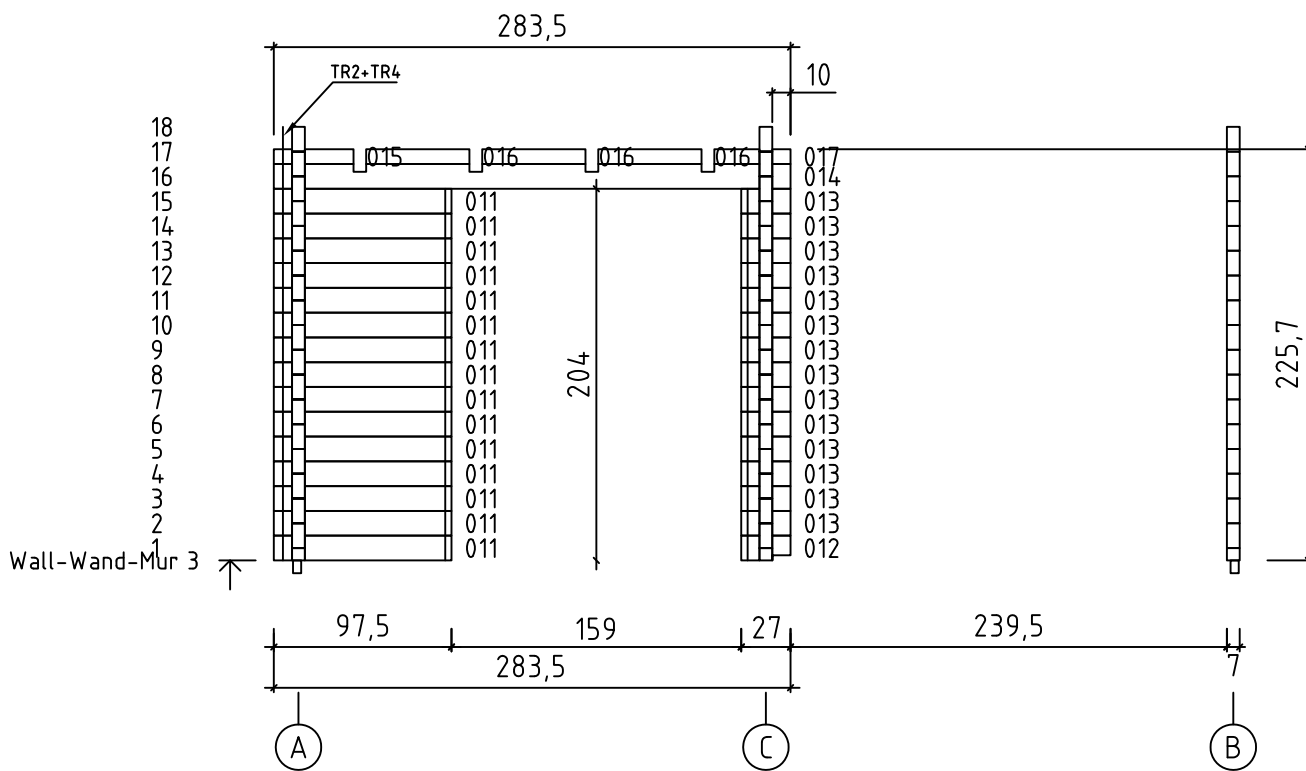

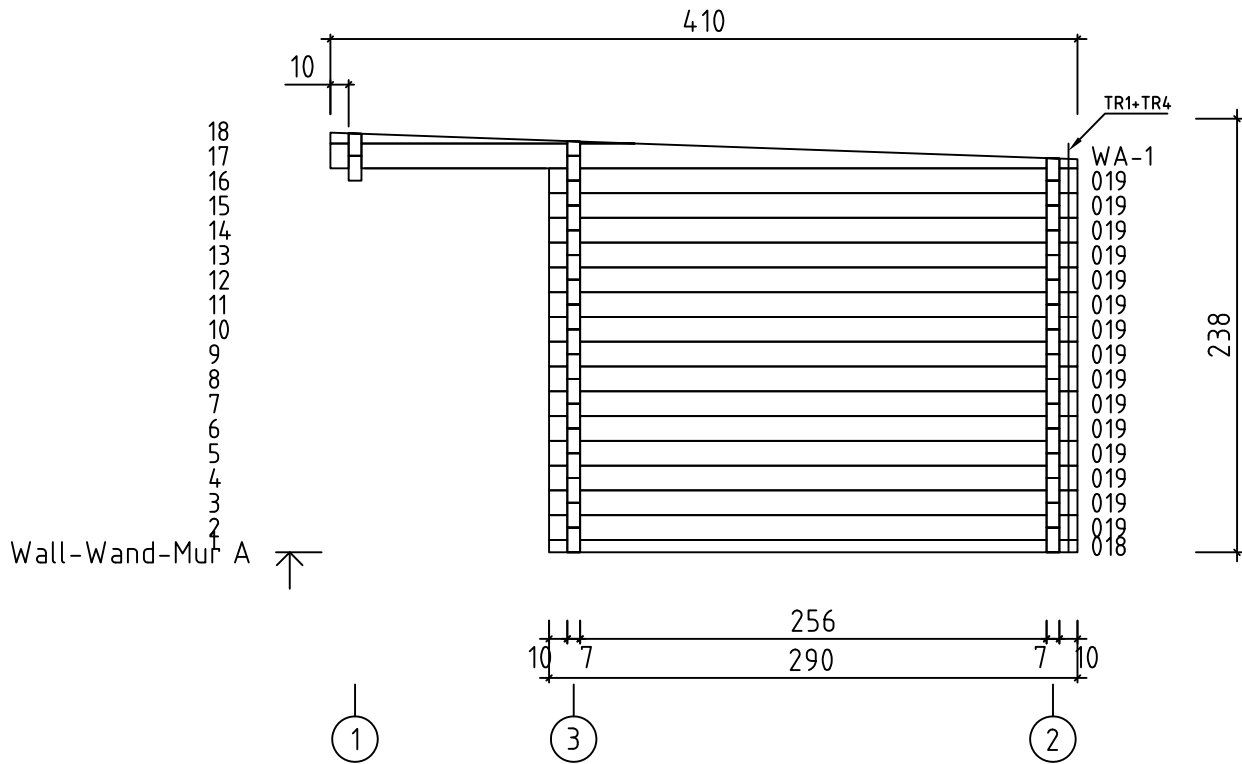
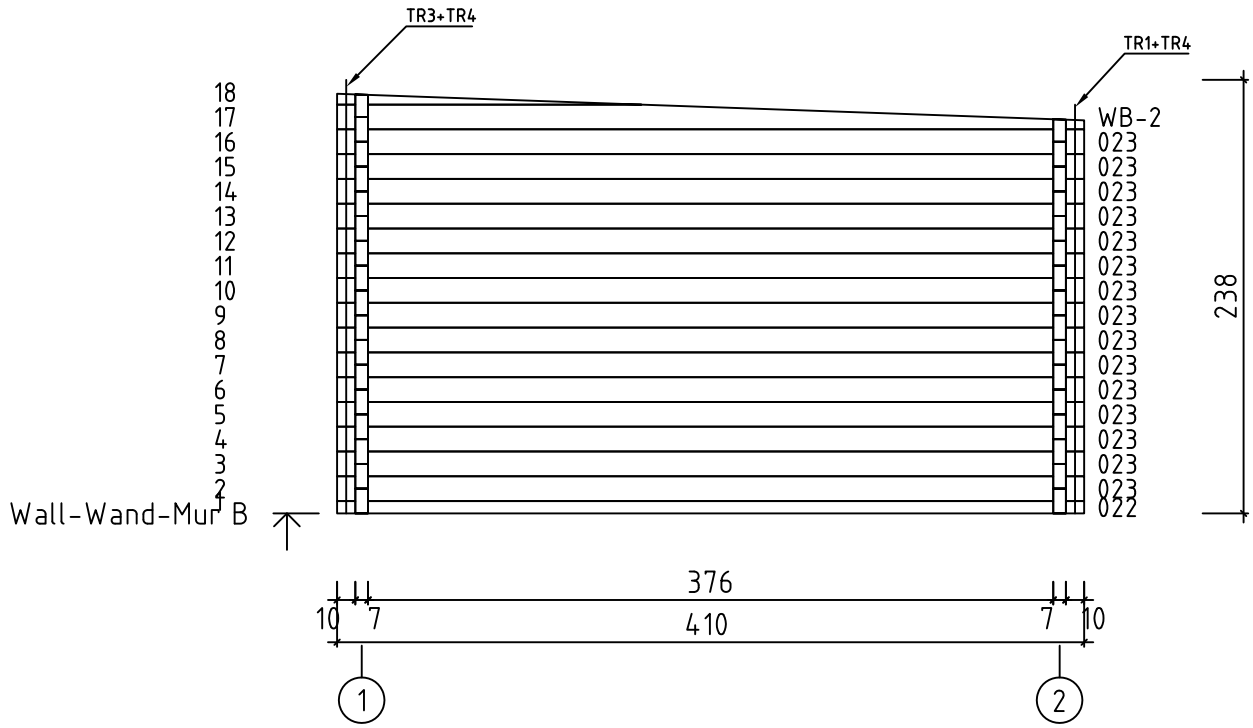

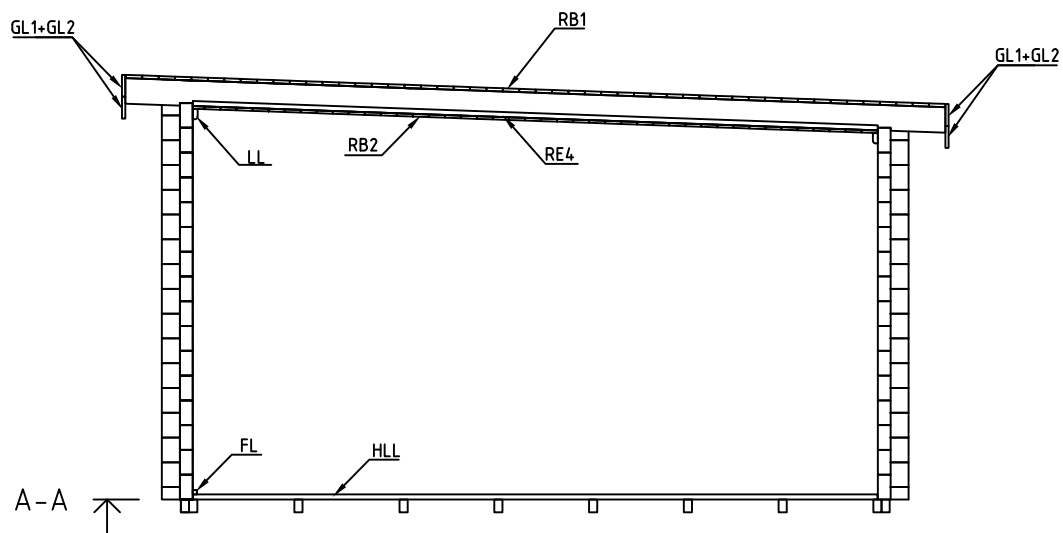
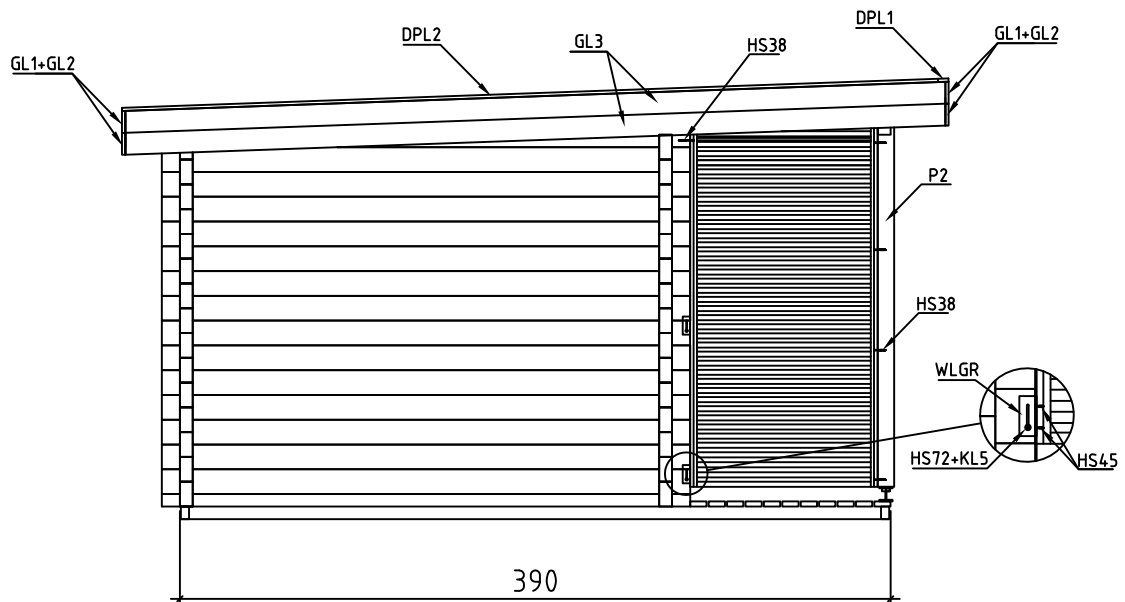
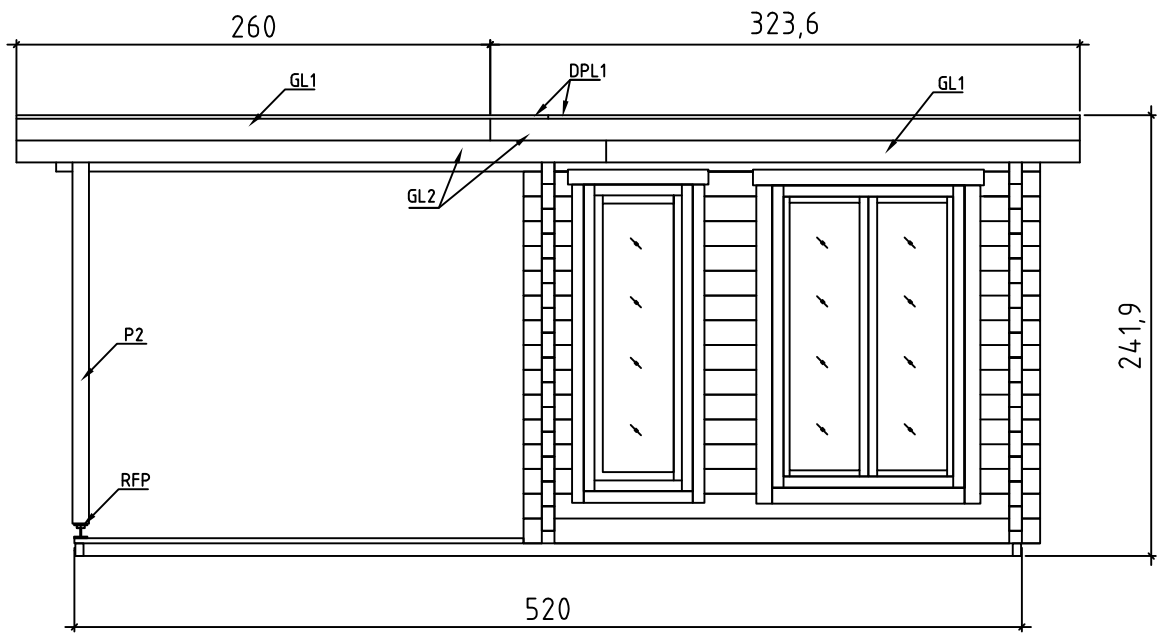

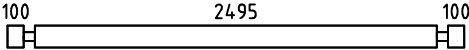

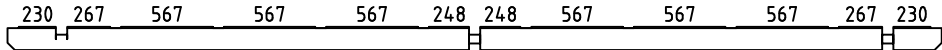
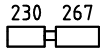
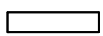
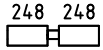
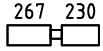
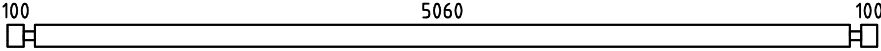
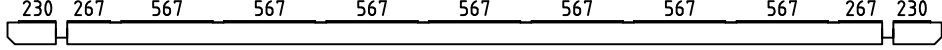
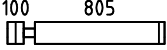

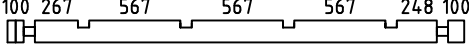

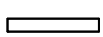

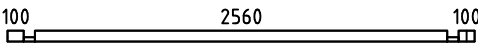
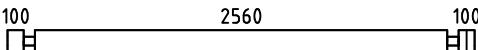
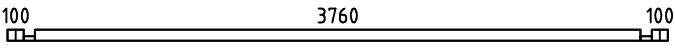
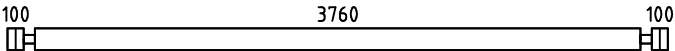
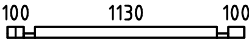
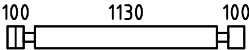
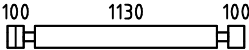
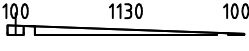

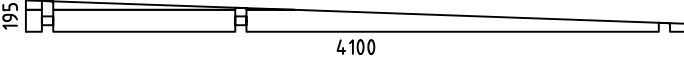
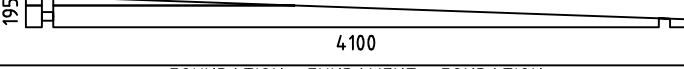
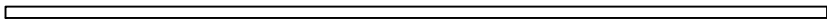

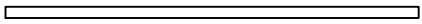

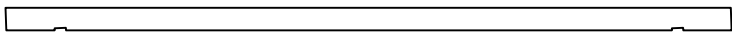
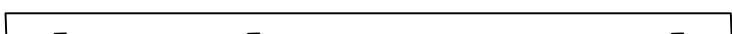
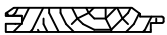
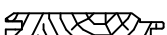

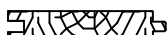



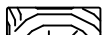
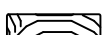



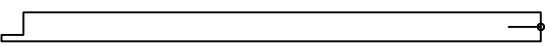





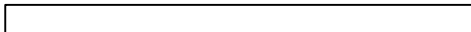





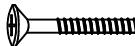







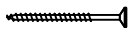

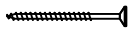



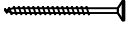





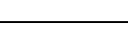

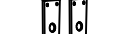

Pos	ART.NR. 704102 Piecze list - Stückliste - Liste des pieces	Q.	P (mm)	L (mm)
001		2	70x136	2835
002		26	70x136	380
003		13	70x136	403
004		1	70x136	5800
005		2	70x124	567
006		13	70x124	567
007		1	70x124	567
008		2	70x124	567
009		14	70x136	5400
010		1	70x136	5800
011		15	70x136	975
012		1	70x136	270
013		14	70x136	270
014		1	70x136	2835
015		1	70x81	437
016		3	70x81	567
017		1	70x81	418
018		1	70x68	2900
019		15	70x136	2900
022		1	70x68	4100
023		15	70x136	4100
026		1	70x68	1470
027		15	70x136	1470
028		1	70x136	1470
029		1	70x59	1470

Pos	ART.NR. 704102 Piece list - Stückliste - Liste des pieces	Q.	P (mm)	L (mm)
WA-1		1		
WB-1		1		
IAR3	FOUNDATION - FUNDAMENT - FONDATION 	8	45x70	5100
IAR1	FOUNDATION - FUNDAMENT - FONDATION 	2	45x70	3890
IAR4	FOUNDATION - FUNDAMENT - FONDATION 	3	45x70	2565
IAR2	FOUNDATION - FUNDAMENT - FONDATION 	5	45x70	1155
SR1	RAFTER - DACHSPARREN - CHEVRON 	6	70x140	4508
SR2	RAFTER - DACHSPARREN - CHEVRON 	4	70x140	4508
RB2	CEILING BOARDS - DECKENBRETTER - VOLIGES SOUS PLAFOND 	24	111x15	5056
RB2	CEILING BOARDS - DECKENBRETTER - VOLIGES SOUS PLAFOND 	10	111x15	2491
HLL	FLOOR BOARDS - FUSSBODENBRETTER - LAME DE PLANCHER 		137x28	117.4m.
RB1	ROOF BOARDS - DACHBRETTER - VOLIGES 	51	90x18	3855
RB1	ROOF BOARDS - DACHBRETTER - VOLIGES 	51	90x18	1945
	TERRACE BOARDS - TERRASSENBRETTER - PLANCHER DE TERRASSE 	10	120x28	2565
FL	FLOOR FILLET-FUSSBODENLEISTE - CORNIERE DE FINITION DU PLANCHER 		18x18	17.62
LL	CEILING FILLET - DECKELEISTE - PROFIL DE FINITION POUR SOUS PLAFOND 		13x40	17.63
DPL1	ROOFING FELT FILLET - DACHPAPPENLEISTE - BAGUETTE DE FIXATION DU FEUTRE BITUMEUX 	2	18x58	2919
DPL2	ROOFING FELT FILLET - DACHPAPPENLEISTE - BAGUETTE DE FIXATION DU FEUTRE BITUMEUX 	2	18x58	4481
TR1	TREADED ROD M12 - GEWINDESTANGE M12 - TIGE FILETÉE M12 	2		190
TR2	TREADED ROD M12 - GEWINDESTANGE M12 - TIGE FILETÉE M12 	1		290
TR3	TREADED ROD M12 - GEWINDESTANGE M12 - TIGE FILETÉE M12 	2		330
TR4	TREADED ROD M12 - GEWINDESTANGE M12 TIGE FILETÉE M12 	5		2000
P2	POST - PFOSTEN - POTEAU 	1	90x90	2000
RE1	HOLDER FOR CEILING BOARDS - HALTER FÜR DECKENBRETTER - SUPPORT POUR PANNEAUX DE PLAFOND 	3	44x44	150
RE2	HOLDER FOR CEILING BOARDS - HALTER FÜR DECKENBRETTER - SUPPORT POUR PANNEAUX DE PLAFOND 	1	44x44	1129

Pos	ART.NR. 704102 Piece list - Stückliste - Liste des pieces		Q.	P (mm)	L (mm)
RE3	HOLDER FOR CEILING BOARDS - HALTER FÜR DECKENBRETTER - SUPPORT POUR PANNEAUX DE PLAFOND		1	44x44	2560
RE4	HOLDER FOR CEILING BOARDS - HALTER FÜR DECKENBRETTER - SUPPORT POUR PANNEAUX DE PLAFOND		1	44x44	3760
GL1	GABLE MOULDING - GIEBELLEISTE PLANCHE DE RIVE		4	18x120	2600
GL2	GABLE MOULDING - GIEBELLEISTE PLANCHE DE RIVE		4	18x120	3236
GL3	GABLE MOULDING - GIEBELLEISTE PLANCHE DE RIVE		4	18x120	4504
LPL	FIXING FILLET - FIXIRUNGSLEISTE - PROFIL DE FIXATION		2	20x70	512
LPL	FIXING FILLET - FIXIRUNGSLEISTE - PROFIL DE FIXATION		1	20x70	1540
LPL	FIXING FILLET - FIXIRUNGSLEISTE - PROFIL DE FIXATION		4	20x70	1729
LPL	FIXING FILLET - FIXIRUNGSLEISTE - PROFIL DE FIXATION		2	20x70	2000
TBE6	FIXING FILLET FOR WINDOW - FIXIRUNGSLEISTE FÜR FENSTER - PROFIL DE FIXATION DES FENETRES		4	28x34	1729
TBE6	FIXING FILLET FOR DOOR - FIXIRUNGSLEISTE FÜR TÜR - PROFIL DE FIXATION DES PORTES		2	28x34	2000
FS	WINDOW HANDLE FITTINGS-FENSTERGRIFF - POIGNÉE D'OUVERTURE DE FENETRE		4		
TS	BOLT FOR WINDOW HANDLE FITTINGS - BOLZEN FÜR FENSTERGRIFF BESCHLAG - BOULON POUR POIGNÉE D'OUVERTURE DE FENETRE		8		
KL4	LENGTHENING BOLT FOR TREADED ROD -VERLÄNGERUNGSMUTTER FÜR GEWINDESTANGE - MANCHON DE RACCORDEMENT DE TIGE FILETÉE		5		
KL1	DRIVE NUT TREADED ROD - EINSHLAGMUTTER FÜR GEWINDESTANGE - ÉCROU A FRAPPER POUR TIGE FILETÉE		5		
KL2	NUT FOR TREADED ROD - MUTTER FÜR GEWINDESTANGE - ÉCROU POUR TIGE FILETÉE		5		
KL3	PLAIN WASHER TREADED ROD - UNTERLEGSSCHEIBE FÜR GEWINDESTANGE - RONDELLE PLATE POUR TIGE FILETÉE		5		
HS16	SCREW FOR GABLE MOULDING - SCHRAUBEN FÜR GIEBELLEISTE - VIS DE FIXATION POUR PLANCHE DE RIVE		110	3.5x50	
HS83	SCREW FOR FIXING FILLET - SCHRAUBEN FÜR FIXIRUNGSLEISTE - VIS POUR PROFIL DE FIXATION		40	3.5x50	
HS84	SCREW FOR FIXING FILLET - SCHRAUBEN FÜR FIXIRUNGSLEISTE - VIS POUR PROFIL DE FIXATION		30	3.5x50	
HS38	SCREW FOR FIXING TERRACE RAILING - SCHRAUBE FÜR TERRASSE VIS DE FIXATION DE GARDE-CORPS DE TERRASSE		5	4.5x80	
HS37	SCREW FOR POST - SCHRAUBEN FÜR PFOSTEN - VIS DE FIXATION DES POTEAUX		2	4.5x80	
HS45	SCREW FOR SLIDING WALL TIE - SCHRAUBEN FÜR WAND SCHIEBEREGLER -		8	4x20	
NFD	SCREW FOR ROOFING FELT FILLET - SCHRAUBEN FÜR DACHPAPPENLEISTE - VIS POUR BAGUETTE FIXATION FEUTRE BITUMEUX		34	4x40	
HS43	SCREW FOR ROOF BEAMS - SCHRAUBEN FÜR DACHBALKEN - VIS POUR PANNE DE TOIT		24	5x120	

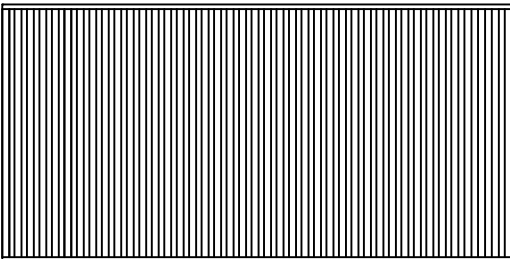
Pos	ART.NR. 704102 Piece list - Stückliste - Liste des pieces		Q.	P (mm)	L (mm)
	SCREW FOR GABLE - SCHRAUBEN FÜR GIEBEL - VIS POUR FIXATION DES PIGNONS		8	5x120	
HS39	SCREW FOR FUNDAMENT - SCHRAUBEN ZUR BEFESTIGUNG FUNDAMENT - VIS POUR FONDATION		34	5x90	
HS81	SCREW FOR CEILING BOARD HOLDER - SCHRAUBE FÜR HALTER FÜR DECKENBRETTER HALTER - VIS DE FIXATION SUPPORT POUR PANNEAUX DE PLAFOND		26	5x90	
HS48	SCREW FOR Pos. 005-008; 015-017 - SCHRAUBEN FÜR für Pos. 005-008; 015-017 VIS POUR FIXATION DERNIÈRE RANGÉE MADRIERS (MURS AVANT ET ARRIÈRE)		46	6x180	
HS49	SCREW FOR POST HEIGHT ADJUSTMENT - SCHRAUBEN FÜR REGULIERUNGSSCHRAUBE FÜR PFOSTEN - VIS DE FIXATION DE SUPPORT RÉGLABLE DE POTEAU		8	6x50	
HS72	SCREW FOR SLIDING WALL TIE - SCHRAUBEN FÜR WAND SCHIEBEREGLER -		2	5x60	
	ZN NAIL FOR TERRACE - ZN NÄGEL FÜR TERRASSENBRETTER - POINTE POUR PLANCHER DE TERRASSE		120	2x50	
SH70	HAMMER BLOCK - SCHLAGHOLZ - CALLE DE FRAPPE		2		
	SCREW FOR DOORSTEP - SCHRAUBEN FÜR TÜRSCHWELLE - VIS DE FIXATION DU SEUIL DE PORTE		3	4.5x65	
NFF	ZN NAIL FOR FLOOR FILLET - ZN NÄGEL FÜR FUSSBODENLEISTE - POINTE POUR CORNIÈRE DE FINITION DU PLANCHER		70	1.4x40	
KL5	PLAIN WASHER M6 - UNTERLEGSCHIEBE M6 - RONDELLE PLATE M6		2		
WLGR	SLIDING WALL TIE - SCHIEBEREGLER FÜR WAND - SABOT MÉTALLIQUE POUR FIXATION MUR		2		
	ZN NAIL FOR ROOF - ZN NÄGEL FÜR DACHBRETTER - POINTE POUR TOIT		645	2x50	
	ZN NAIL FOR CEILING BOARDS - ZN NÄGEL FÜR DECKENBRETTER - CLOUS POUR VOLIGES SOUS PLAFONDS		316	2x50	
	ZN NAIL FOR FLOOR - ZN NÄGEL FÜR FUSSBODENBRETTER - CLOUS POUR PLANCHER		274	2x50	
TS4	SET OF DOOR LOCK COVERS - SCHLOSSBLENDEN - SET DE GARNITURES DE SERRURE DE PORTE		1		
TS3	DOOR HANDLE FITTINGS-TÜRGRIF - SET DE GARNITURES DE SERRURE DE PORTE		1		
TS6	CYLINDER LOCK -ZYLINDERSCHLOSS - CYLINDRE DE SERRURE		1		
RFP	POST HEIGHT ADJUSTMENT - REGULIERUNGSSCHRAUBE FÜR PFOSTEN - SUPPORT RÉGLABLE DE POTEAU		1		
	TERRACE RAILING - TERRASSE - GARDE-CORPS DE TERRASSE		1		2000

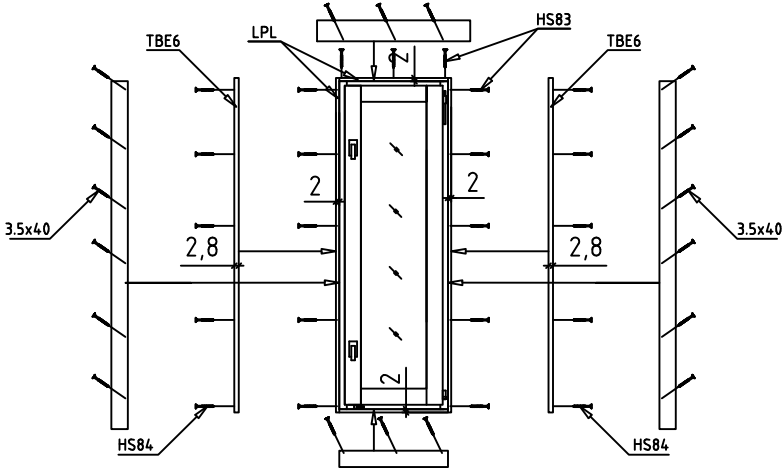
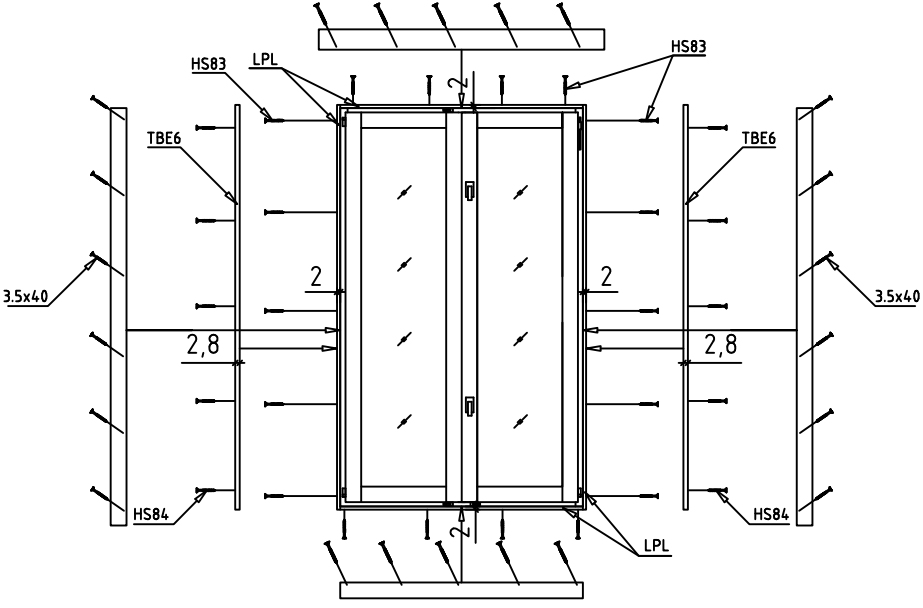
Pos	ART.NR. 704102 Piece list - Stückliste - Liste des pieces	Q.	P (mm)	L (mm)
Premium A.OP.b	WINDOW-FENSTER-FENETRE 512x1689 			
Premium TA.OVP	WINDOW-FENSTER-FENETRE 1060x1689 			
Premium TU .10P.b	DOOR-TÜR-PORTE 1540x1980 