

Oxfordshire 53
Art. Nr. 4414002
1/8

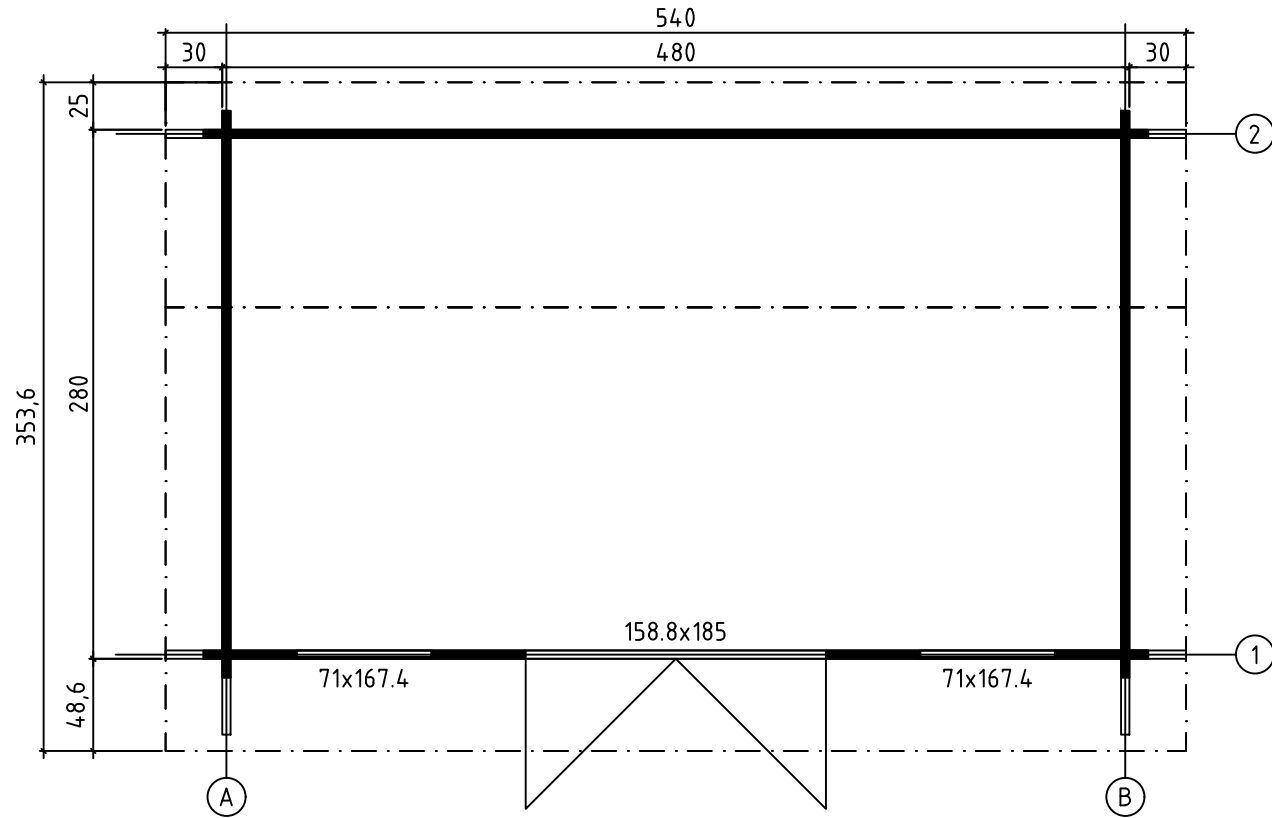

Art.Nr. 4414002

GROUNDPLAN - GRUNDPLAN - PLAN DE MASSE



FOUNDATION - FUNDAMENT - FONDATION

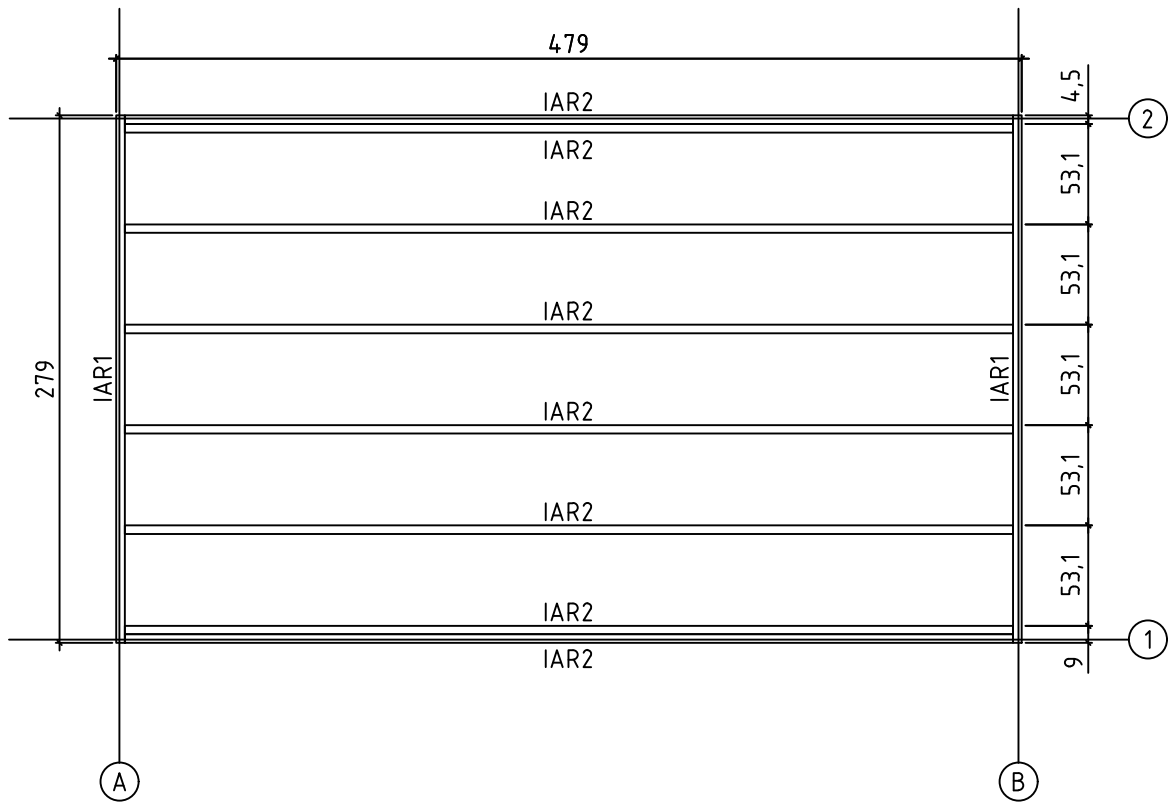



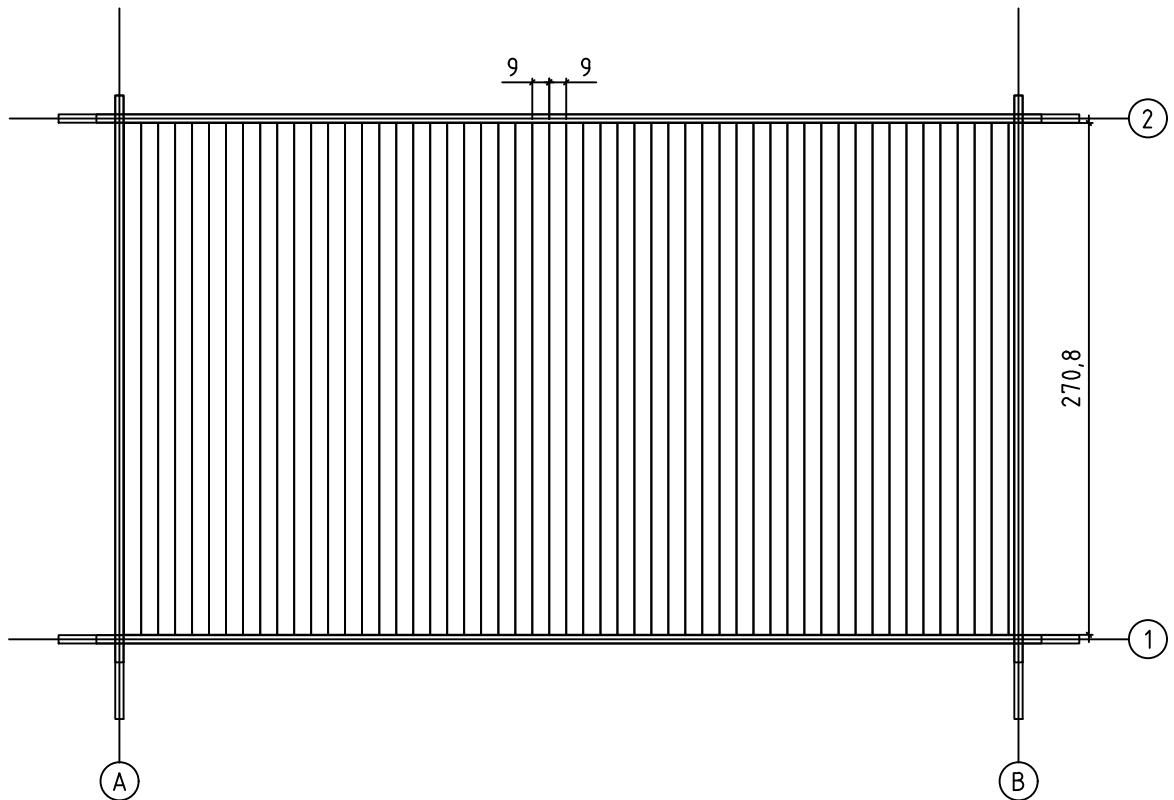

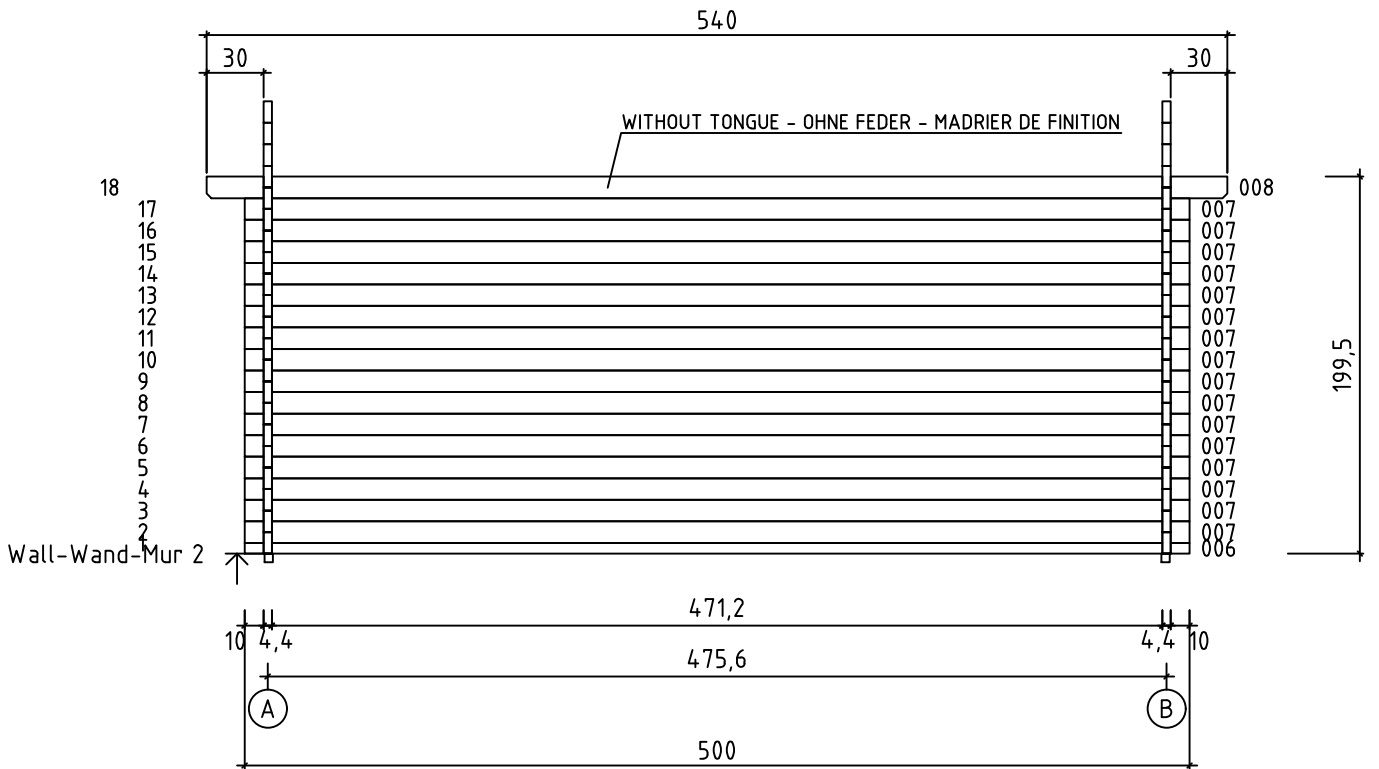
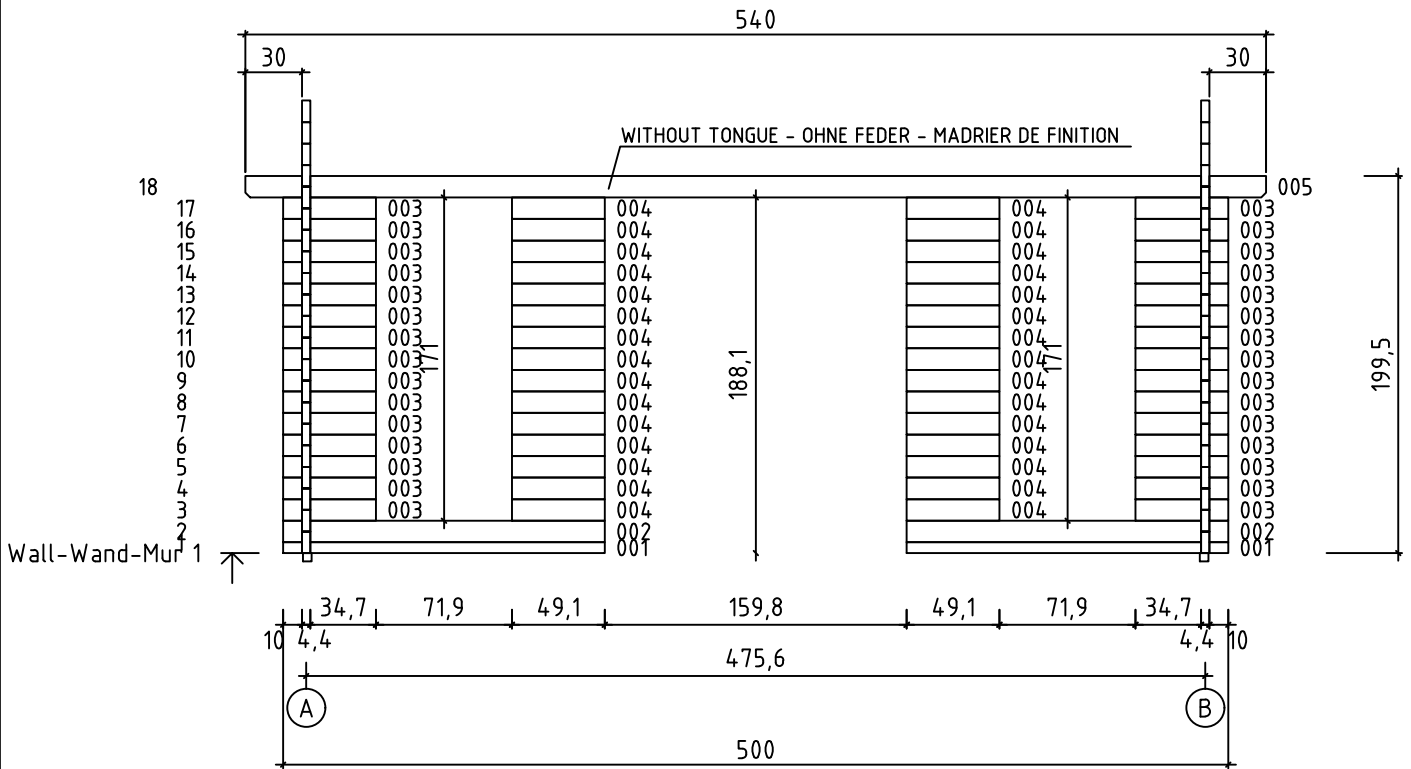

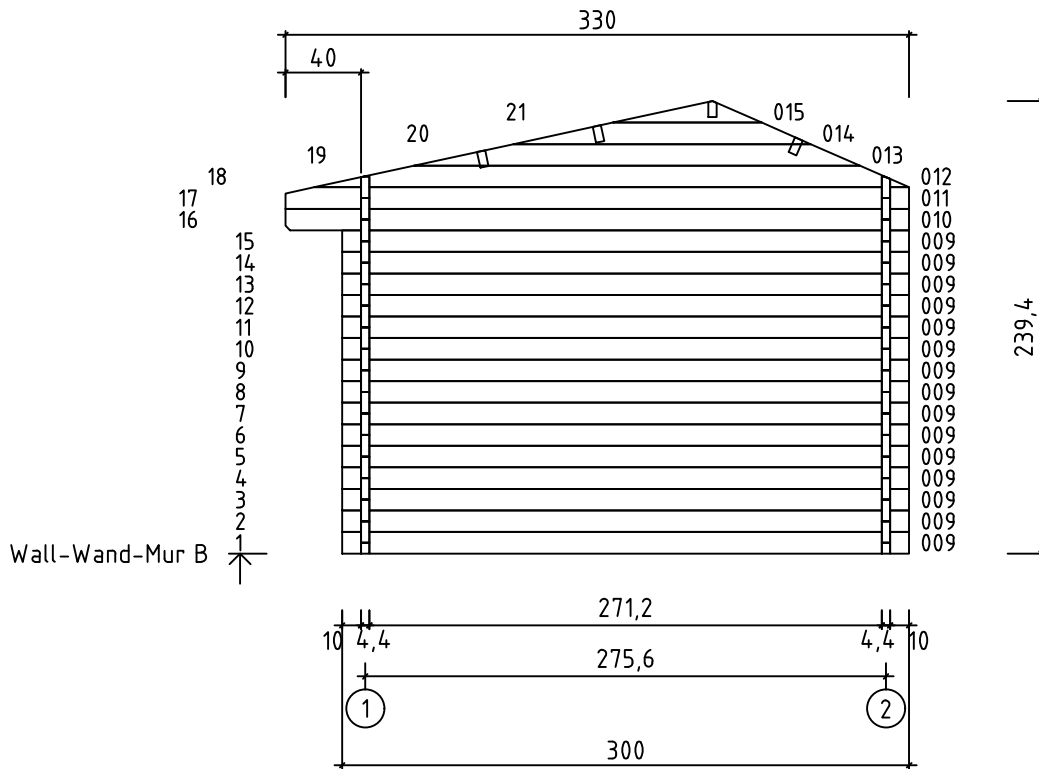
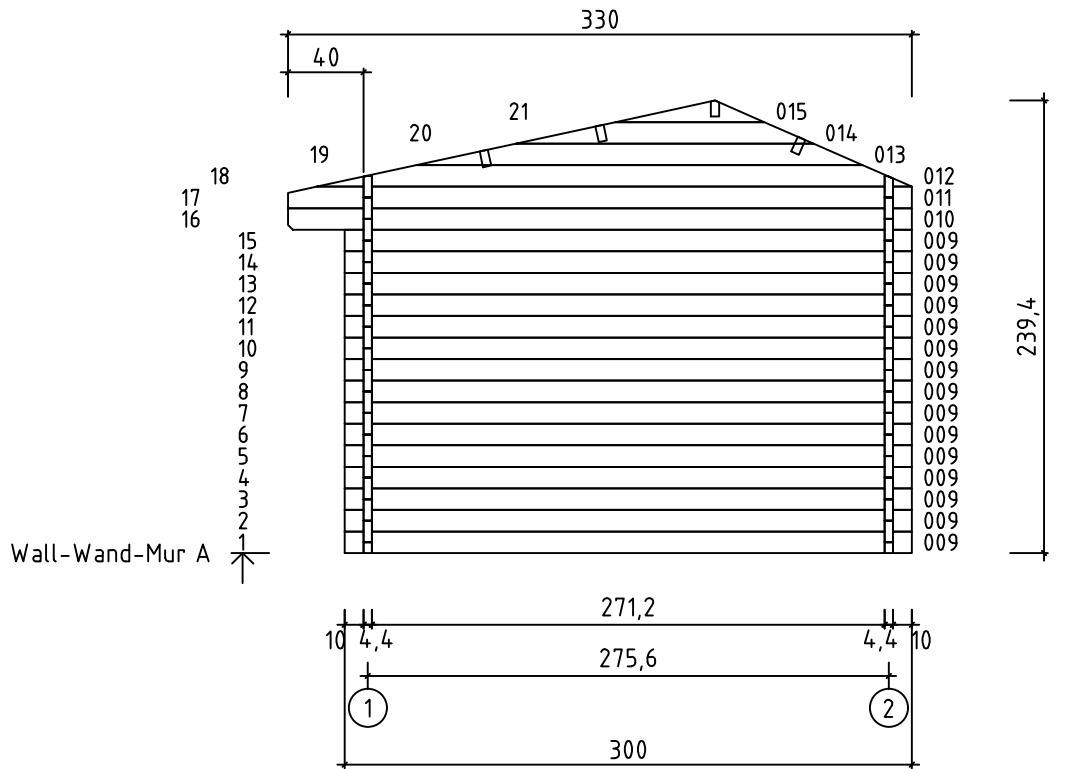

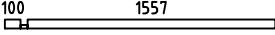
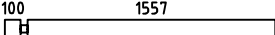

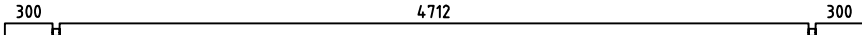
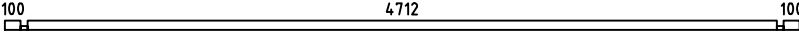
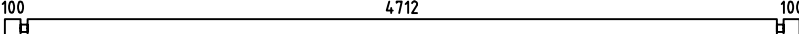
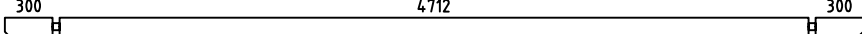
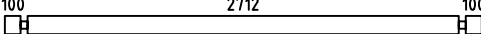
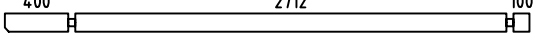
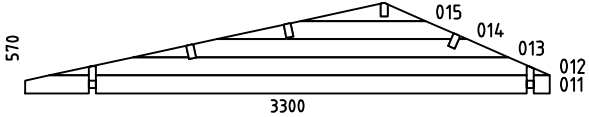
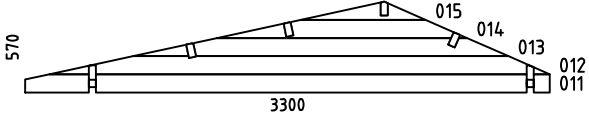
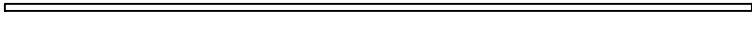
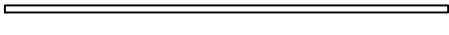
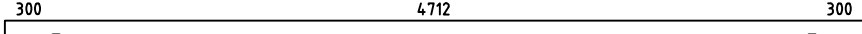
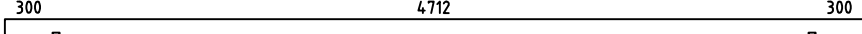





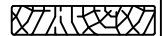



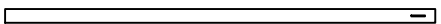
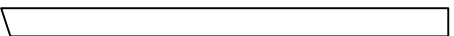
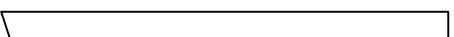

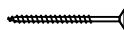
FLOOR BOARDS - FUSSBODENBRETTER - PLAN POSE PLANCHER

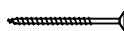
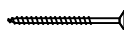
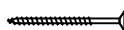
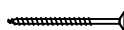
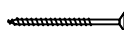

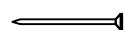

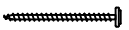
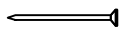
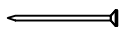
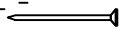

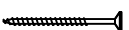

Pos	30.06.2016	Piece list - Stückliste - Liste des pièces Art.Nr. 4414002	6/8	Q.	P (mm)	L (mm)
001				2	44x57	1701
002				2	44x114	1701
003				30	44x114	491
004				30	44x114	491
005				1	44x120	5400
006				1	44x57	5000
007				16	44x114	5000
008				1	44x120	5400
009				30	44x114	3000
010				2	44x114	3300
WA-1				1		
WB-1				1		
IAR2		FOUNDATION - FUNDAMENT - FONDATION 		8	45x45	4700
IAR1		FOUNDATION - FUNDAMENT - FONDATION 		2	45x45	2790
PR1		ROOF BEAM - DACHBALKEN - PANNE DE TOIT 		1	44x140	5400
A-PR1		ROOF BEAM - DACHBALKEN - PANNE DE TOIT 		3	44x140	5400
		FLOOR BOARDS - FUSSBODENBRETTER - LAME DE PLANCHER 		53	90x18	2708
		ROOF BOARDS - DACHBRETTER - VOLIGES 		60	90x18	2400
		ROOF BOARDS - DACHBRETTER - VOLIGES 		60	90x18	1300
FL		FLOOR FILLET-FUSSBODENLEISTE - CORNIERE DE FINITION DU PLANCHER 			18x18	14.83
DPL		ROOFING FELT FILLET - DACHPAPPENLEISTE - BAGUETTE DE FIXATION DU FEUTRE BITUMEUX 		2	18x58	1350
DPL		ROOFING FELT FILLET - DACHPAPPENLEISTE - BAGUETTE DE FIXATION DU FEUTRE BITUMEUX 		2	18x58	2450
TB		EAVES BOARD - TRAUFBRETT - BANDEAU DE TOIT 		4	18x58	2700

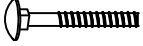
Pos	30.06.2016	Piece list - Stückliste - Liste des pièces Art.Nr. 4414002	7/8	Q.	P (mm)	L (mm)
DRV		ROOF EDGE REINFORCEMENT - DACHRANDVERSTÄRKUNG - CORNIERE DE RENFORT DE BORD DE TOIT		4	28x34	2700
KFS		STORM PROTECTION - STURMLEISTE - LATTE ANTI-TEMPETE		4	22x45	2050
GL		GABLE MOULDING - GIEBELLEISTE - PLANCHE DE RIVE		2	18x120	1350
GL		GABLE MOULDING - GIEBELLEISTE - PLANCHE DE RIVE		2	18x120	2450
FS		WINDOW HANDLE FITTINGS-FENSTERGRIFF - POIGNÉE D'OUVERTURE DE FENETRE		2		
HS43		SCREW FOR ROOF BEAMS - SCHRAUBEN FÜR DACHBALKEN - VIS POUR PANNE DE TOIT		12	5x120	
HS40		SCREW FOR 1. WALL BEAM - SCHRAUBE FÜR 1. BOHLENREIHE - VIS DE FIXATION DES FONDATIONS		8	5x90	
HS41		SCREW FOR DOOR JAMB - SCHRAUBE FÜR TÜRRAHMEN - VIS DE FIXATION POUR MONTANT DE PORTE		4	5x90	
		SCREW FOR GABLE SEGMENT - SCHRAUBEN FÜR DECKBLATT - VIS POUR FIXATION LOSANGE DE FINITION		4	3.5x50	
		SCREW FOR GABLE MOULDING - SCHRAUBEN FÜR GIEBELLEISTE - VIS DE FIXATION POUR PLANCHE DE RIVE		28	3.5x50	
		SCREW FOR DOOR FILLET - SCHRAUBE ZUR BEFESTIGUNG TÜRLEISTE - VIS D'ASSEMBLAGE DU CADRE DE PORTE		5	3x30	
		SCREW FOR EAVES BOARDS - SCHRAUBEN FÜR TRAUFBRETTER - VIS DE FIXATION POUR BANDEAU DE TOIT		24	4x40	
		SCREW FOR FUNDAMENT - SCHRAUBEN ZUR BEFISTIGUNG FUNDAMENT - VIS POUR FONDATION		16	5x90	
		SCREW FOR FUNDAMENT - SCHRAUBEN ZUR BEFISTIGUNG FUNDAMENT - VIS POUR FONDATION		8	5x90	
NFF		ZN NAIL FOR FLOOR FILLET - ZN NÄGEL FÜR FUSSBODENLEISTE - POINTE POUR CORNIERE DE FINITION DU PLANCHER		30	1.4x40	
		DOOR HANDLE FITTINGS-TÜRGRIFF - SET DE GARNITURES DE SERRURE DE PORTE		1		
SH44		HAMMER BLOCK - SCHLAGHOLZ - CALLE DE FRAPPE		1		
		SCREW FOR DOORSTEP - SCHRAUBEN FÜR SWELLE - - VIS DE FIXATION DU SEUIL DE PORTE		3	4.5x65	
		ZN NAIL FOR ROOF - ZN NÄGEL FÜR DACHBRETTER - POINTE POUR TOIT		377	2x50	
		ZN NAIL FOR FLOOR - ZN NÄGEL FÜR FUSSBODENBRETTER - CLOUS POUR PLANCHER		324	2x50	
		ZN NAIL FOR ROOFING FELT FILLET - ZN NÄGEL FÜR DACHPAPPENLEISTE - POINTE POUR BAGUETTE FIXATION FEUTRE BITUMEUX		20	2x40	
		MALE BOLT HINGE FOR DOOR - TÜRRIEGEL - - PARTIE MALE DE CHARNIERE DE PORTE		6		
		SCREW FOR ROOF EDGE REINFORCEMENT - SCHRAUBEN FÜR DACHRANDVERSTÄRKUNG - VIS POUR RENFORT DE BORD DE TOIT		24	4x40	
GS		GABLE SEGMENT-DECKBLATT - LOSANGE DE FINITION		2		
		NUT FOR STORM PROTECTION - SCHRAUBENMUTTER FÜR STURMLEISTE - ÉCROU POUR LAME ANTI-TEMPETE		8		

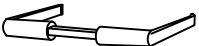
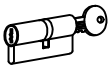
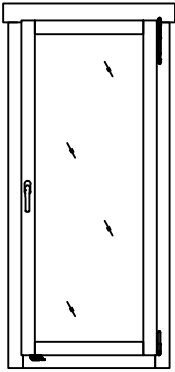
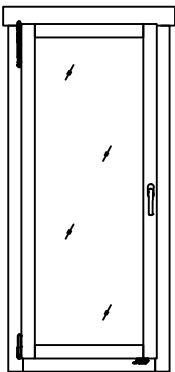
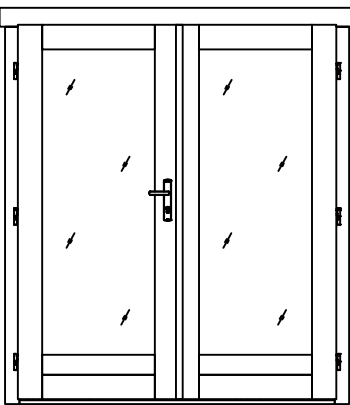
Pos	30.06.2016	Piece list - Stückliste - Liste des pièces Art.Nr. 4414002	8/8	Q.	P (mm)	L (mm)
BFS		BOLT FOR STORM PROTECTION - BOLZEN FÜR STURMLEISTE - VIS POUR LAME ANTI-TEMPETE		8		
DFS		WASHER FOR STORM PROTECTION - DICHTSCHEIBE FÜR STURMLEISTE - RONDELLE POUR LAME ANTI-TEMPETE		8		
		DOOR HANDLE FITTINGS-TÜRGRIFF - SET DE GARNITURES DE SERRURE DE PORTE		1		
TS6		CYLINDER LOCK -ZYLINDERSCHLOSS - CYLINDRE DE SERRURE		1	30x35	
		WINDOW - FENSTER - FENETRE 710x1674 AK.1.100.PSP.p DGP+		1		
		WINDOW - FENSTER - FENETRE 710x1674 AK.1.100.PSV.p DGP+		1		
		DOOR - TÜR - PORTE 1588x1850 TUK.1.100.PVV.MMa DGP+		1		