

*Domeo 8*  
*Art. Nr. 4426719*  
*1/22*

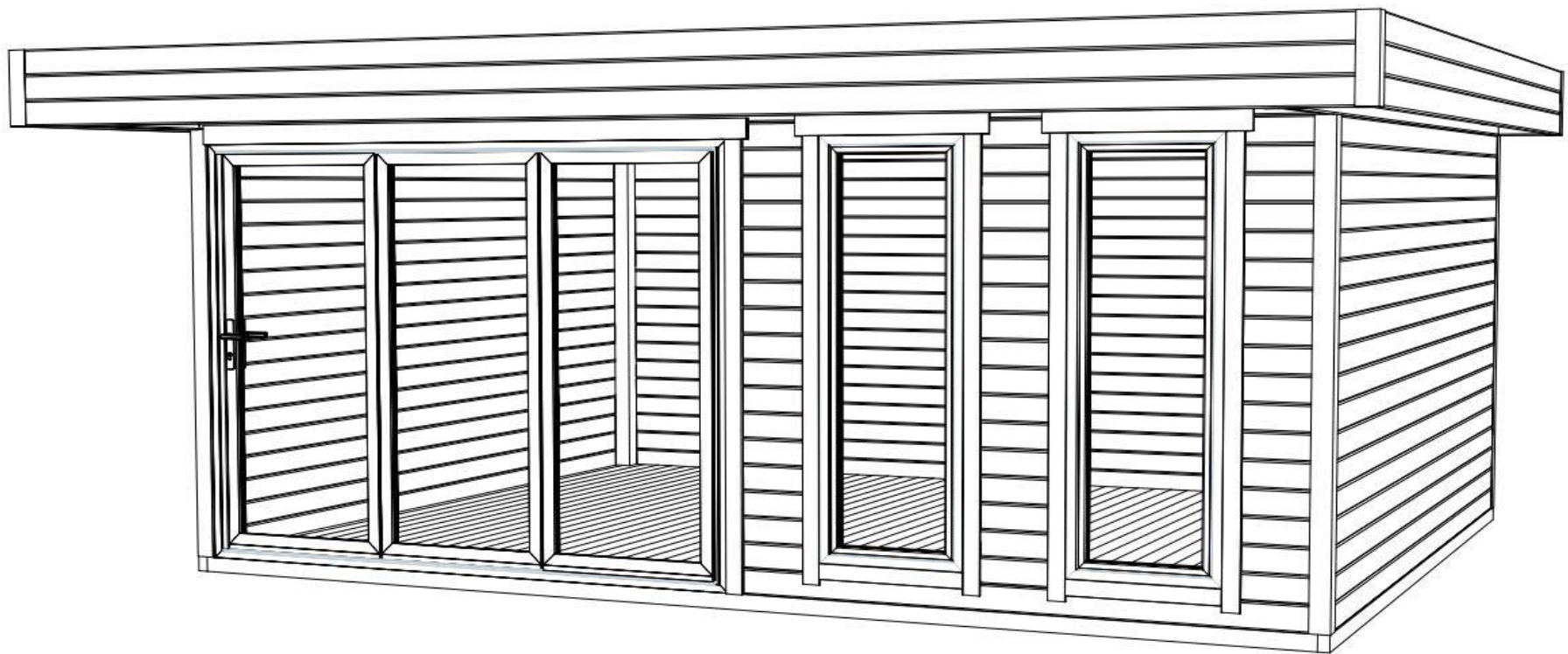

Art. Nr. 4426719

Groundplan - Grundplan - Plan de masse - Planimetria - Plattegrond - Põhiplaan

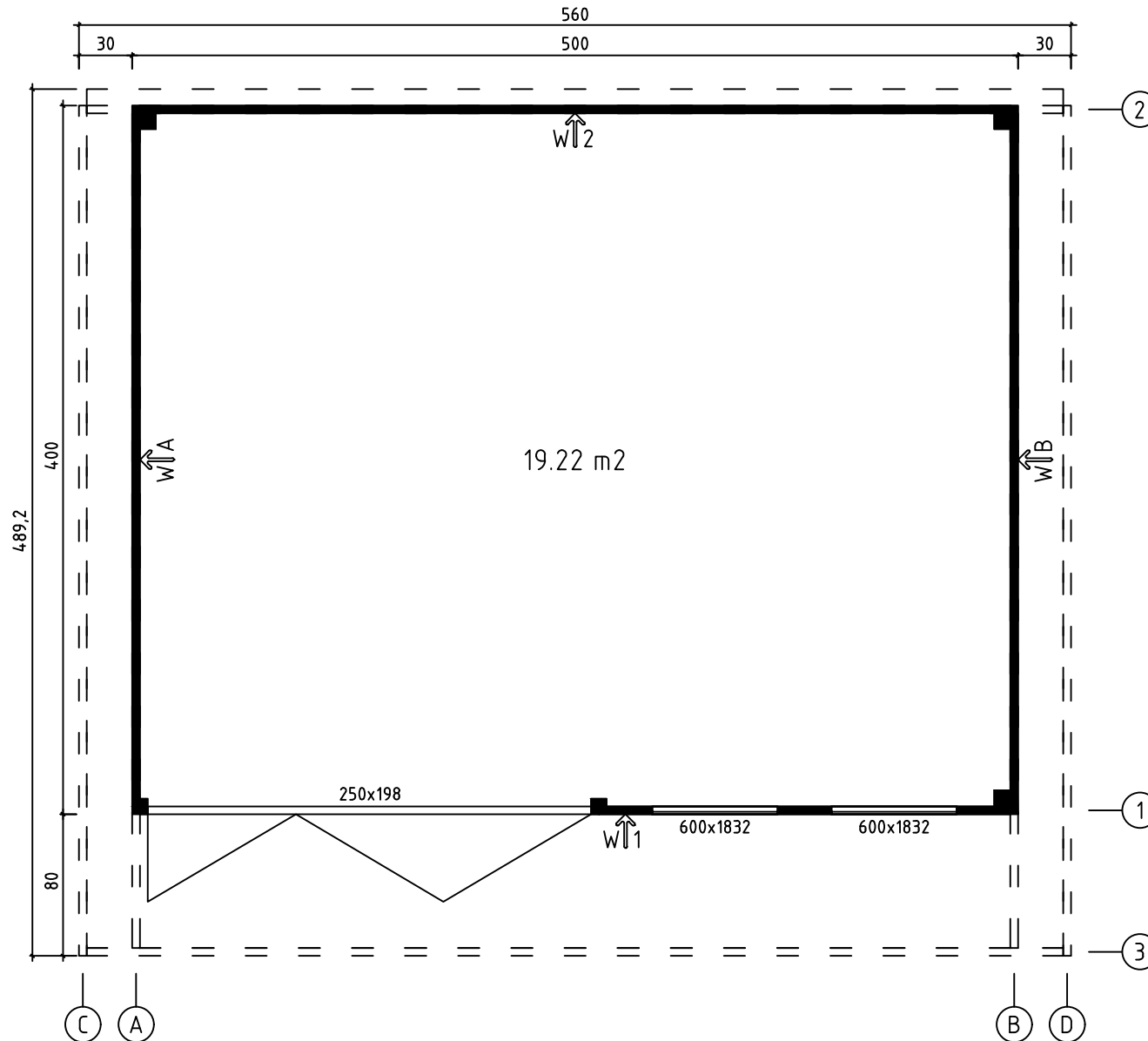

31.08.2021

2/22

Art. Nr. 4426719

Foundation - Fundament - Fondation - Fundamenta - Fundering - Immutatud alusraam

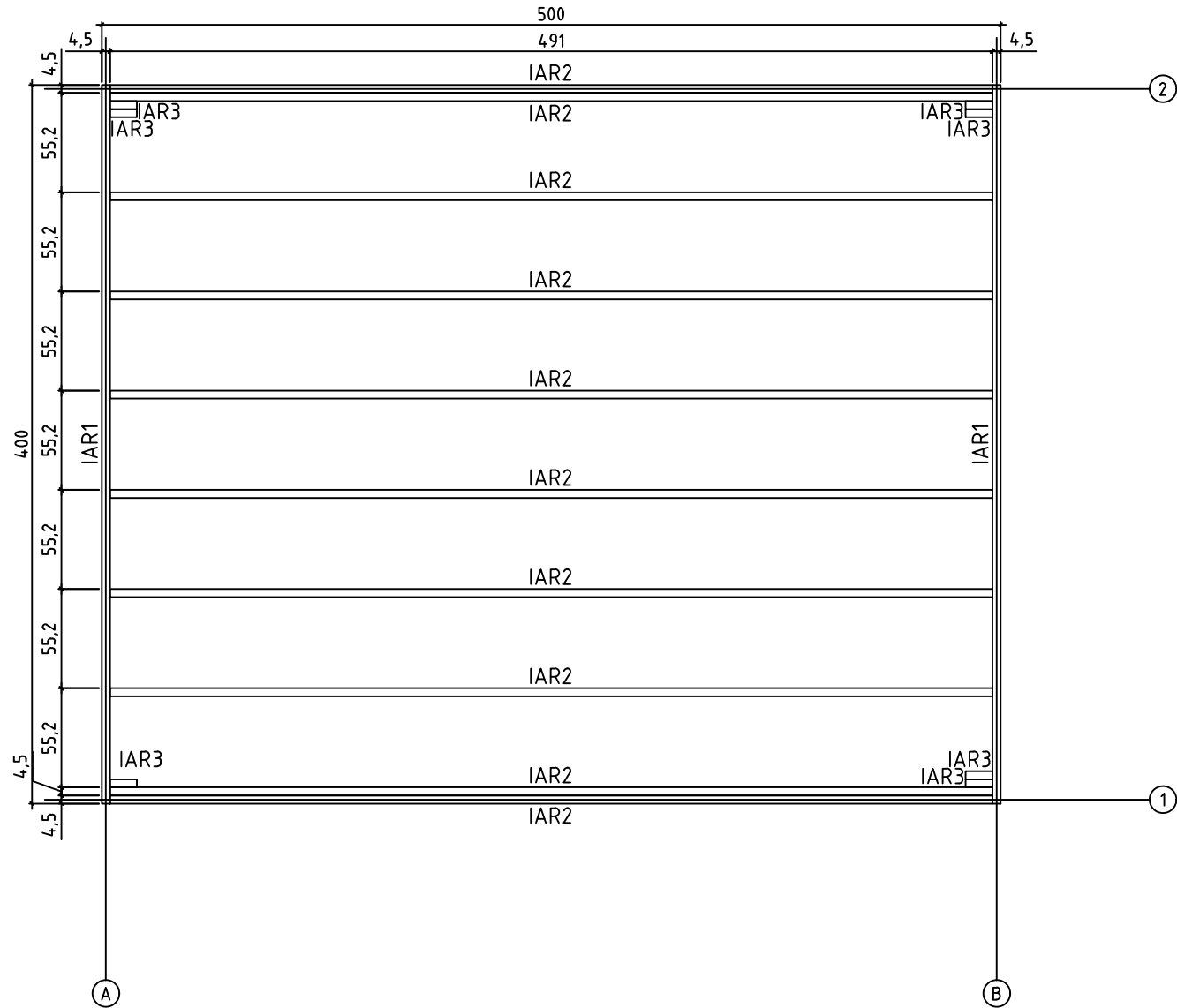

Art. Nr. 4426719

Floor boards - Fussbodenbretter - Plan poseplancher - Pavimento - Vloerhout - Põrandalaudis

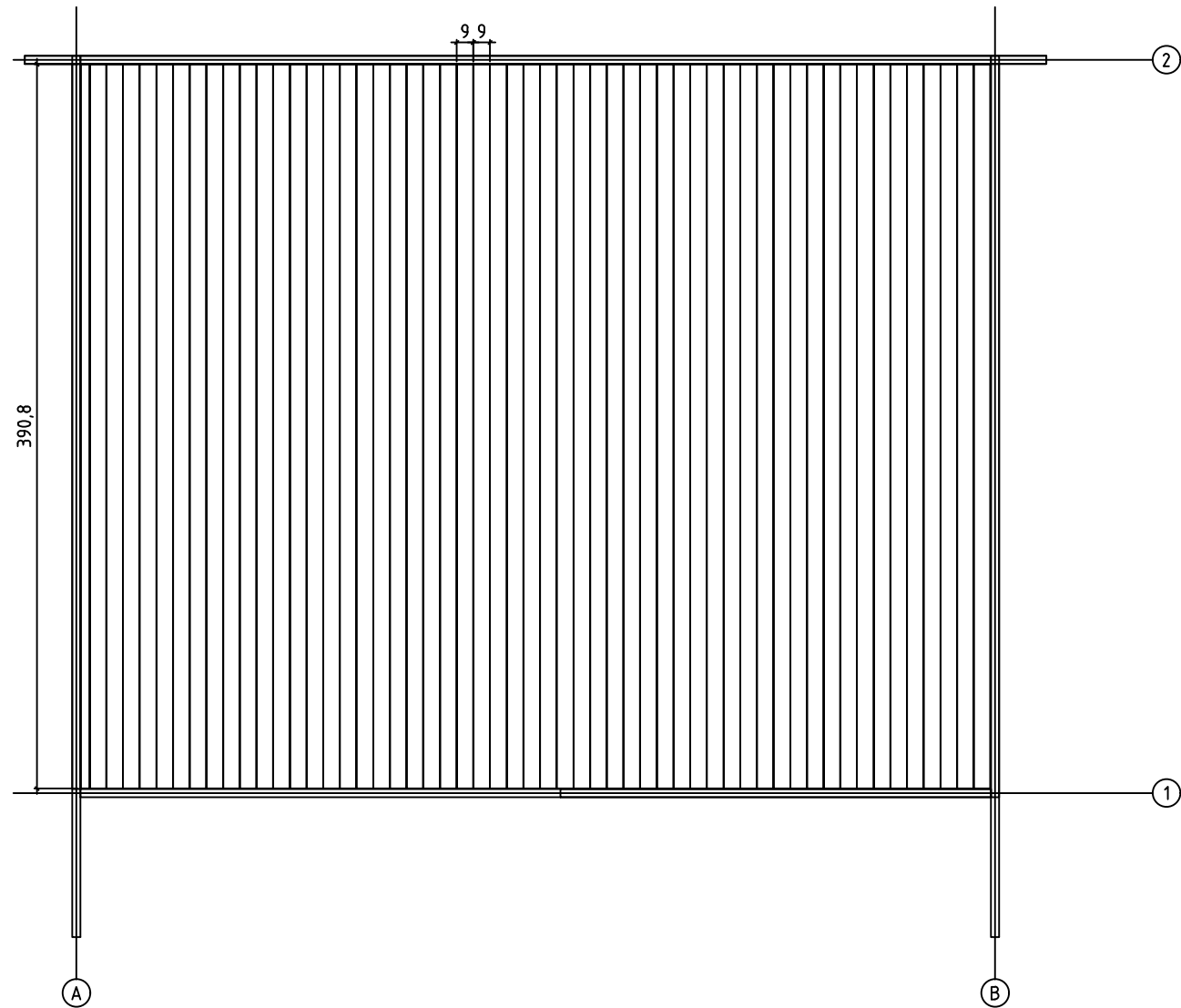

31.08.2021

4/22

Art. Nr. 4426719

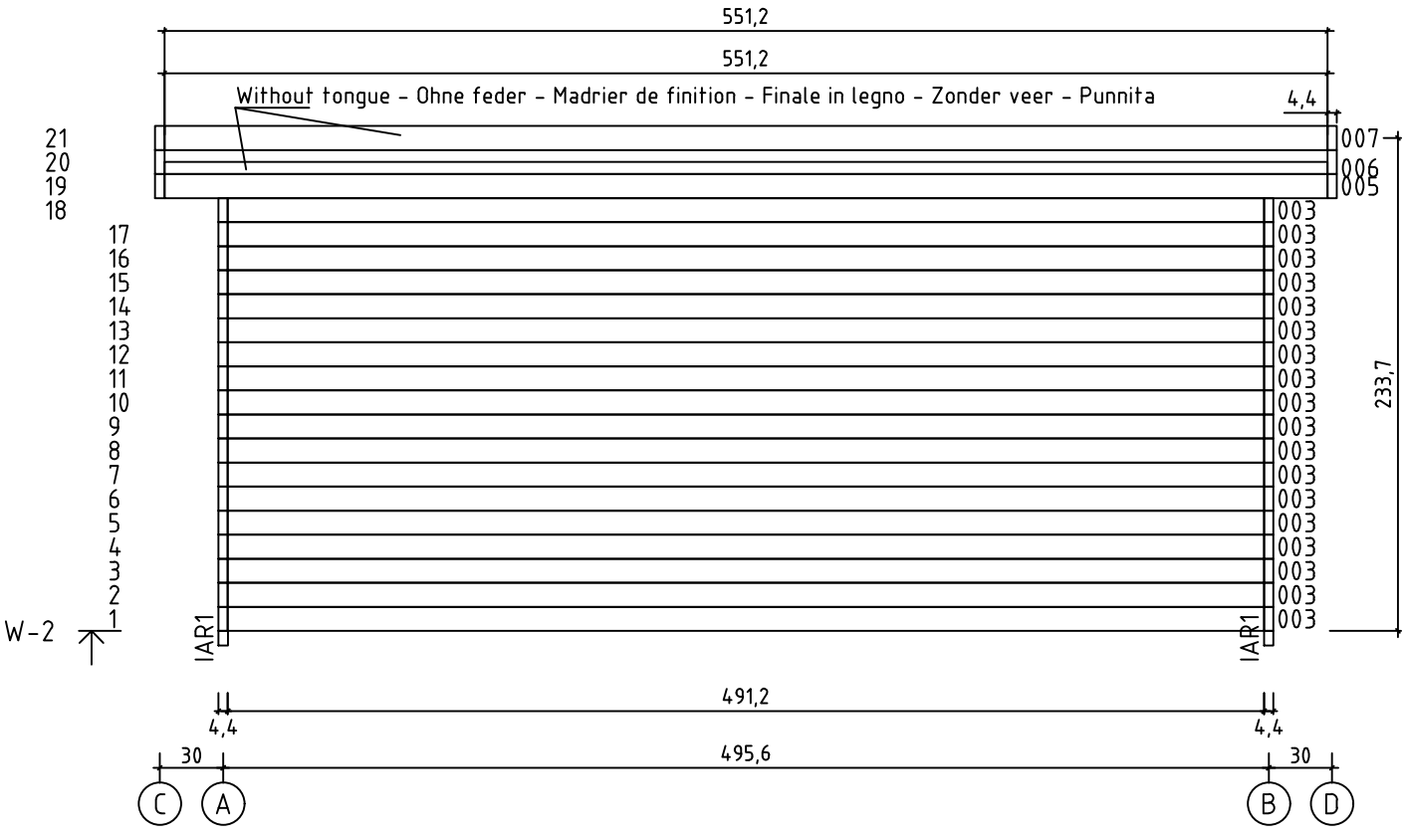
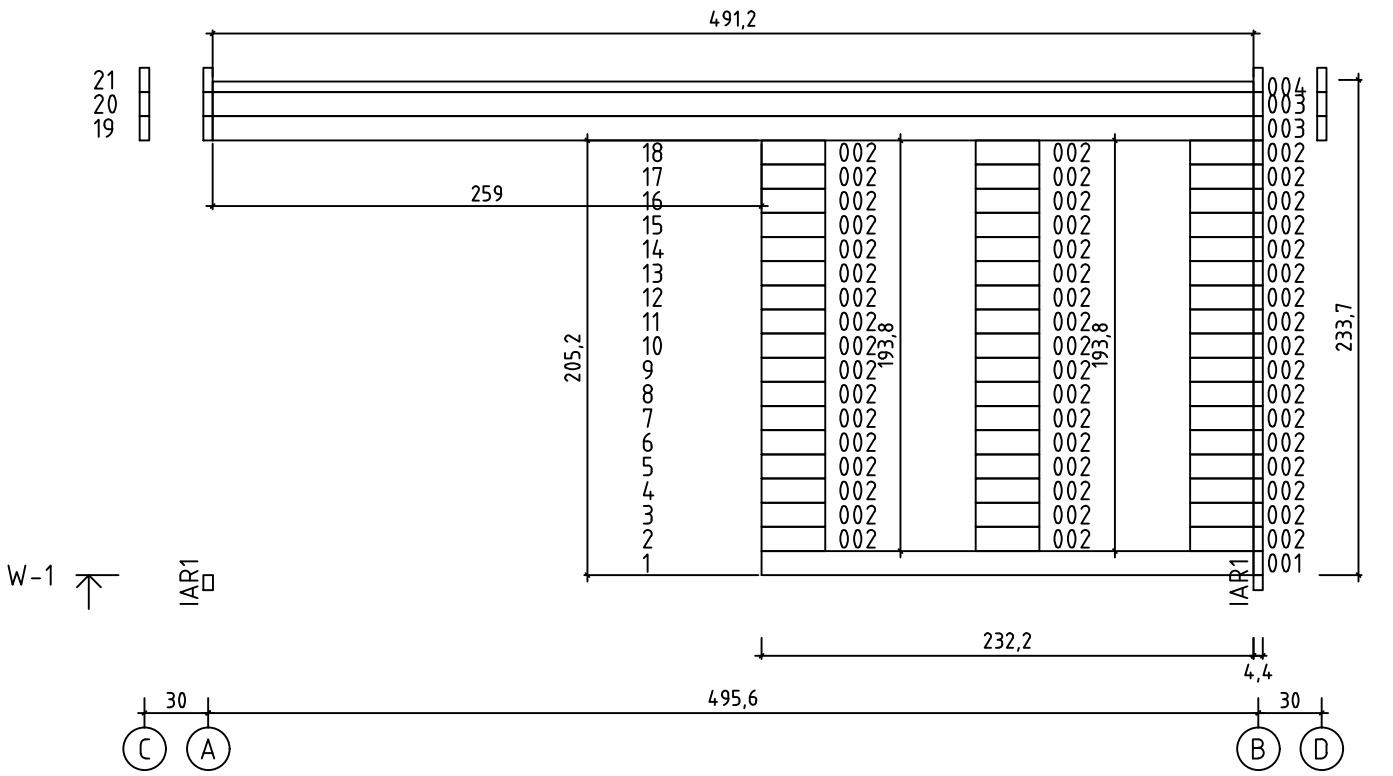



Art. Nr. 4426719

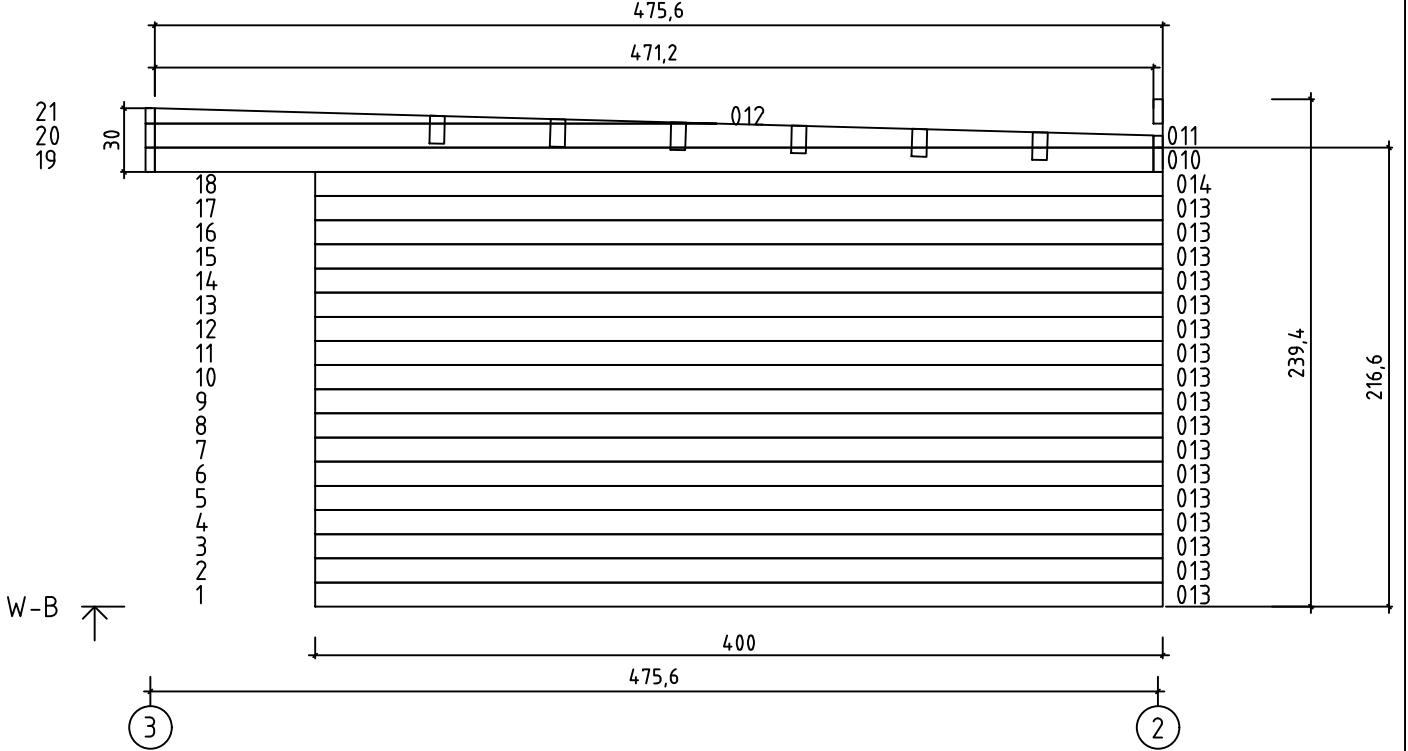



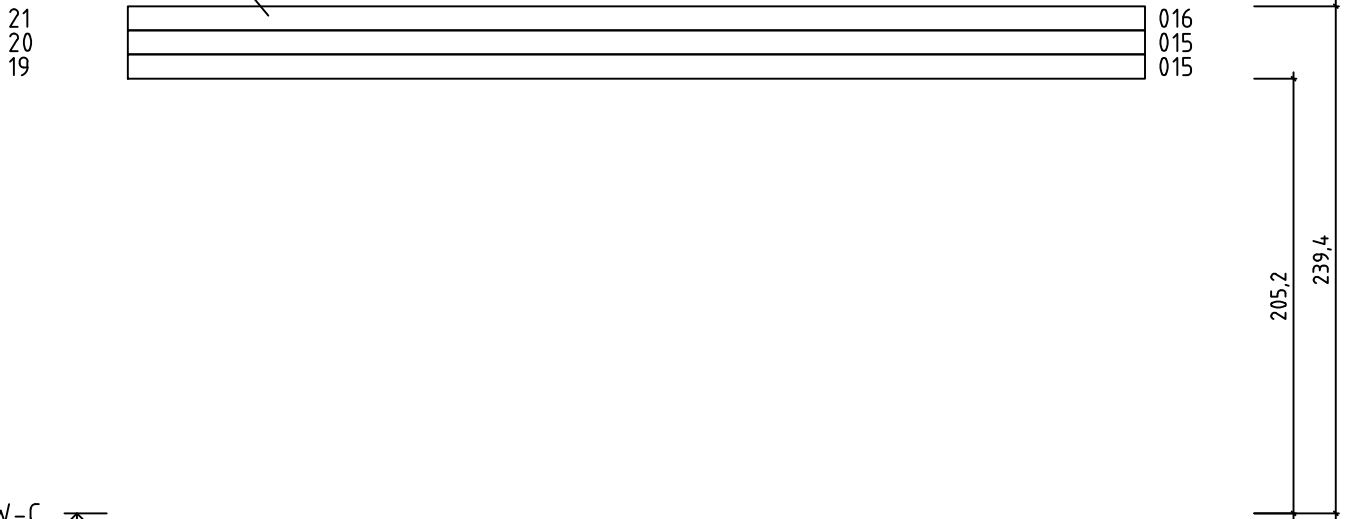



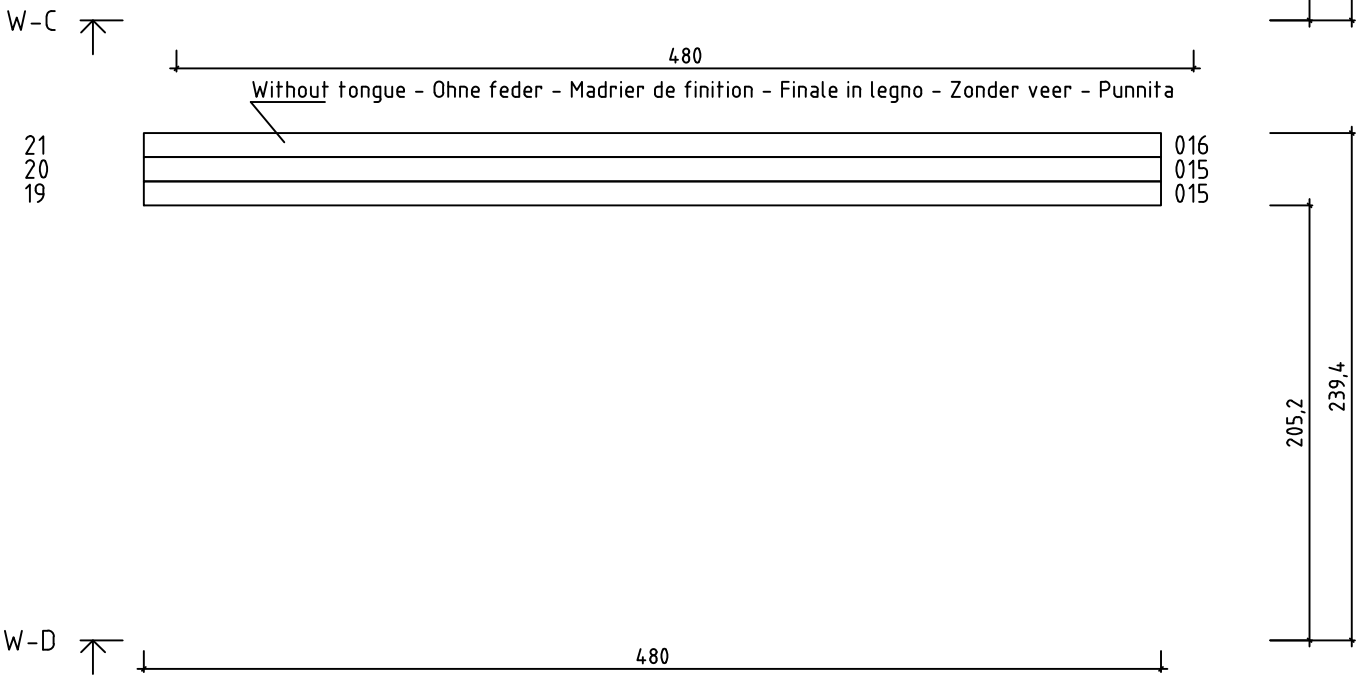

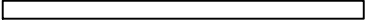

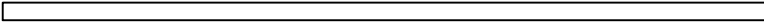
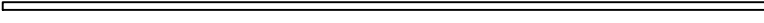
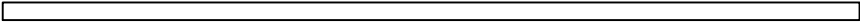
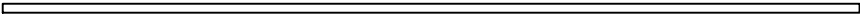
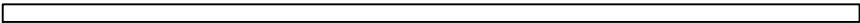
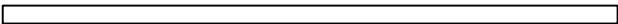
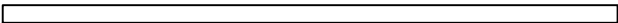
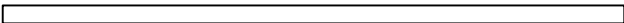
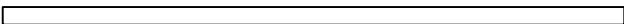

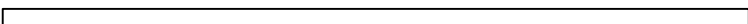
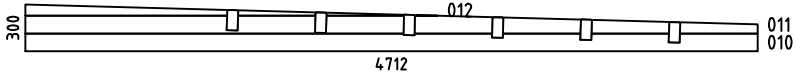
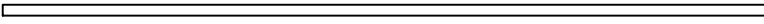
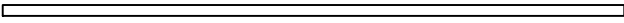



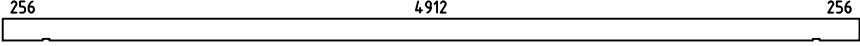





Without tongue - Ohne feder - Madrier de finition - Finale in legno - Zonder veer - Punnita



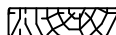
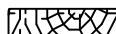
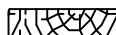
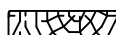
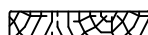
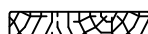
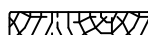

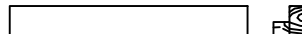

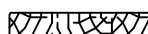







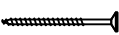

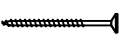





Without tongue - Ohne feder - Madrier de finition - Finale in legno - Zonder veer - Punnita

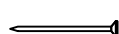

Pos	31.08.2021 Piece list - Stückliste - Liste des pièces - Elementi - Stuklijst - Tükítabel Art. Nr. 4426719 8/22	Q	P (mm)	L (mm)
001		1	44x114	2322
002		51	44x114	300
003		20	44x114	4912
004		1	44x50	4912
005		3	44x114	5512
006		1	44x57	5512
007		2	44x114	5512
008		17	44x114	3956
009		1	44x114	3956
013		17	44x114	4000
014		1	44x114	4000
015		4	44x114	4800
016		2	44x114	4800
WA-1 WB-1		1 1		
	Foundation - Fundament - Fondation - Fondamenta - Fundering - Immutatud alusraam			
IAR2		10	45x70	4910
	Foundation - Fundament - Fondation - Fondamenta - Fundering - Immutatud alusraam			
IAR1		2	45x70	4000
	Foundation - Fundament - Fondation - Fondamenta - Fundering - Immutatud alusraam			
IAR3		7	45x70	150
	Lath - Pfetten - Liteau - Piccola asse - Gordingen - Roov			
RV2		1	44x44	4822
	Lath - Pfetten - Liteau - Piccola asse - Gordingen - Roov			
RV1		2	44x44	166
	Roof beam - Dachbalken - Panne de toit - Perlina del tetto - Gordingen / dakbalk - Pärilin			
A-PR1		6	70x140	5512
	Roof beam - Dachbalken - Panne de toit - Perlina del tetto - Gordingen / dakbalk - Pärilin			
A-PR2		2	70x140	256
FB	Floor boards - Fussbodenbretter - Lamé de plancher - Pavimento - Vloerhout - Põrandalaud 	55+1	90x18	3908
DB	Roof boards - Dachbretter - Voliges - Perlina per tetto - Dakhout - Katuselaud 	62+1	90x18	4850

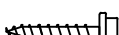
Pos	31.08.2021 Piece list - Stückliste - Liste des pièces - Elementi - Stuklijst - Tükitalabel Art. Nr. 4426719 9/22	Q	P (mm)	L (mm)
FF	Floor fillet - Fussbodenleiste - Corniere de finition du plancher - Finitura per pavimento (battisco pa) - Vloerafwerkljst - Pörandaliist 		18x18	18
DPP-1	Roofing felt fillet - Dachpappenleiste - Baguette de fixation du feutre bitumeux - Asse per fissaggio guaina bituminosa - Afdekljst asfaltpapier - Katusepapiilist 	4	18x58	2371
DPP-2	Roofing felt fillet - Dachpappenleiste - Baguette de fixation du feutre bitumeux - Asse per fissaggio guaina bituminosa - Afdekljst asfaltpapier - Katusepapiilist 	2	18x58	2800
TL-2	Covering moulding - Deckungsprofil - Profils de finition verticaux a fixer a l'exterieur du cadre de la porte - Cornice di finitura - Afdek profiel - Lengipuu 	4	38x46	612
TL-3	Covering moulding - Deckungsprofil - Profils de finition verticaux a fixer a l'exterieur du cadre de la porte - Cornice di finitura - Afdek profiel - Lengipuu 	4	38x46	1900
TL-1	Covering moulding - Deckungsprofil - Profils de finition verticaux a fixer a l'exterieur du cadre de la porte - Cornice di finitura - Afdek profiel - Lengipuu 	1	38x46	2500
PL5	Railing strip - Begrenzungsleiste - Rembarde - Sbarra - Afscheidingslijst - Piirdelaud 	2	18x70	600
PL4	Railing strip - Begrenzungsleiste - Rembarde - Sbarra - Afscheidingslijst - Piirdelaud 	2	18x70	612
PL3	Railing strip - Begrenzungsleiste - Rembarde - Sbarra - Afscheidingslijst - Piirdelaud 	8	18x70	1927
PL2	Railing strip - Begrenzungsleiste - Rembarde - Sbarra - Afscheidingslijst - Piirdelaud 	2	18x70	1980
TL	Railing strip - Begrenzungsleiste - Rembarde - Sbarra - Afscheidingslijst - Piirdelaud 	1	18x70	2500
PL6	Railing strip - Begrenzungsleiste - Rembarde - Sbarra - Afscheidingslijst - Piirdelaud 	4	18x90	802
PL2	Railing strip - Begrenzungsleiste - Rembarde - Sbarra - Afscheidingslijst - Piirdelaud 	1	18x90	2500
PL2	Railing strip - Begrenzungsleiste - Rembarde - Sbarra - Afscheidingslijst - Piirdelaud 	1	18x90	2605
P4	Post - Pfosten - Poteau - Piede registrabile - Stijl - Post 	20	44x44	170
P5	Post - Pfosten - Poteau - Piede registrabile - Stijl - Post 	4	44x44	298
P2	Post - Pfosten - Poteau - Piede registrabile - Stijl - Post 	1	88x88	2300
P3	Post - Pfosten - Poteau - Piede registrabile - Stijl - Post 	1	88x88	2052
P	Post - Pfosten - Poteau - Piede registrabile - Stijl - Post 	2	90x90	2200
P1	Post - Pfosten - Poteau - Piede registrabile - Stijl - Post 	1	90x90	2300
TB-1	Fascia board - Traufbrett - Bandeau de toit - Finitura lati tetto - Gevellijst - Räästalaud 	2	18x90	2756
DRV-1	Roof edge reinforcement - Dachrandverstärkung - Corniere de renfort de bord de toit - Rinforzo x tetto - Dakrand versterking - Räästatugevdus 	2	28x34	2756
FF	Fixing fillet - Fixierungsleiste - Profil de fixation - Massello di fissaggio - Bevestiging lijstwerk - Tenderliist 	4	18x44	

Pos	31.08.2021 Piece list - Stückliste - Liste des pièces - Elementi - Stuklijst - Tükítabel Art. Nr. 4426719	10/22	Q	P (mm)	L (mm)
	Fascia sheet - Abschlussprofil - Profil de finition métallique pour débord de toiture - Scossalina di protezione dall'acqua per bordo di legno - Afdek profiel / boordprofiel - Räästaplekk		2		2200
	Fascia sheet - Abschlussprofil - Profil de finition métallique pour débord de toiture - Scossalina di protezione dall'acqua per bordo di legno - Afdek profiel / boordprofiel - Räästaplekk		6		3100
HS9	Screw for covering moulding - Schrauben für deckungsprofil - Vis de fixation profils horizontaux haut inférieur et extérieur d'encadrement de porte - Vite per cornice di copertura - Schroef voor afdekprofiel - Kruvi piirdetauale		86	3.5x50	1900
HS12	Screw for fixing fillet of door and window - Schrauben für fixierungsleiste - Vis pour profil vertical de fixation pour ouvertures des fenetres et portes - Viti per massello di fissaggio - Schroeven voor bevestiging van deur en raam lijsten - Kruvi tenderliistudele		68	4x40	
HS12	Screw for door jamb - Schraube für türrahmen - Vis de fixation partie haute avec montants du cadre de porte - Viti x fissaggio montanti porte - Schroef voor deurkozijn - Kruvi ukse lengile		4	4x40	
HS18	Screw for roof beams - Schrauben für dachbalken - Vis pour fixation pannes de toit - Viti per perline del tetto - Schroef voor gordingen / dakbalken - Kruvi pärlinitele		12	5x120	
HS18	Screw for door jamb - Schraube für türrahmen - Vis de fixation partie haute avec montants du cadre de porte - Viti x fissaggio montanti porte - Schroef voor deurkozijn - Kruvi ukse lengile		19	5x120	
HS34	Screw for window jamb - Schraube für fenesterrahmen - Vis de fixation pour montant de fenetre - Viti per finestra ad oblo - Schroef voor vensterbank - Kruvi akna lengile		484	5x80	
HS16	Screw for window jamb - Schraube für fenesterrahmen - Vis de fixation pour montant de fenetre - Viti per finestra ad oblo - Schroef voor vensterbank - Kruvi akna lengile		8	5x90	
HS16	Screw for foundation - Schrauben zur befestigung fundament - Vis de fixations des poutrelles de fondations - Viti x fondamenta - Schroef voor fundering - Kruvi alusraamile		20	5x90	
HS16	Screw for post - Schrauben für pfosten - Vis de fixation des poteaux - Viti per inviare - Schroef voor stijlen - Kruvi postile		12	5x90	
HS16	Screw for wall details - Schraube für wand details - Vis pour mur details - Viti per elementi della porta - Schroef voor wand details - Kruvi seinadetailidele		12	5x90	
HS16	Screw for foundation - Schrauben zur befestigung fundament - Vis de fixations des poutrelles de fondations - Viti x fondamenta - Schroef voor fundering - Kruvi alusraamile		15	5x90	
HS22	Screw for 1. wall beam - Schraube für 1. bohlenreihe - Vis de fixations 1ere rangée de madriers avec poutrelles de fondations - Vite fissaggio alle fondamenta - Schroef voor 1 wandbalk - Kruvi poollauale		12	6x150	
HS22	Screw for window jamb - Schraube für fenesterrahmen - Vis de fixation pour montant de fenetre - Viti per finestra ad oblo - Schroef voor vensterbank - Kruvi akna lengile		12	6x150	
HS23	Screw for wall details - Schraube für wand details - Vis pour mur details - Viti per elementi della porta - Schroef voor wand details - Kruvi seinadetailidele		342	6x180	
HS21	Screw for roof lath - Schraube für dachlatte - Vis pour latte - Vite per listello del tetto - Schroef voor daklat - Kruvi roovile		12	6x80	
NF2	Zn nail for floor fillet - Zn nagel für fussbodenleiste - Pointe pour corniere de finition du plancher - Chiodi x fissaggio pavimento - Spijker(nagel) voor vloer afdeklijst - Nael põrandaliistule		36	1.4x40	
NF4	Zn nail for roof - Zn nagel für dachbretter - Pointe pour fixation voliges de toit - Chiodi x perline tetto - Spijker(nagel) voor dakhout - Nael katuselauale		592	2x50	
NF4	Zn nail for floor - Zn nagel für fussbodenbretter - Clous pour plancher - Chiodi x perline pavimento - Spijker(nagel) voor vloer - Nael põrandalauale		456	2x50	
NF5	Zn nail for roofing felt fillet - Zn nagel für dachpappenleiste - Pointe pour baguette de fixation feutre bitumeux - Chiodi x carta bituminosa x tetto - Spijker(nagel) voor asfaltpapier afdeklijst - Papiliistunael		38	2x40	
HS28	Screw for fascia sheet - Schraube für abschlussprofil - Vis pour profil de finition métallique pour débord de toiture - Viti per fissare i folgi di gronda - Schroef voor afsluit (afdek)profiel - Katusekruvi		50	4.8x32	
	Fascia sheet corner - Eckprofil - Profil d'habillage de rives - Scossalina di protezione dall'acqua per angolo di borbo in legno - Hoekprofiel - Räästapleki nurk		4		

Art. Nr. 4426719

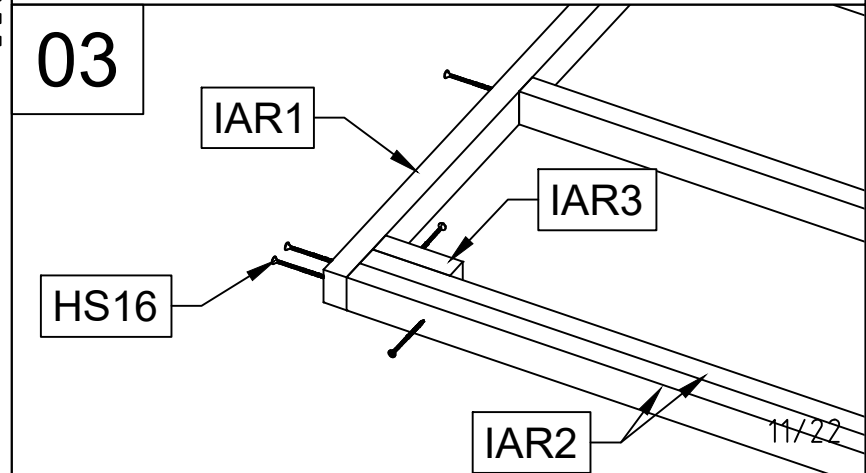
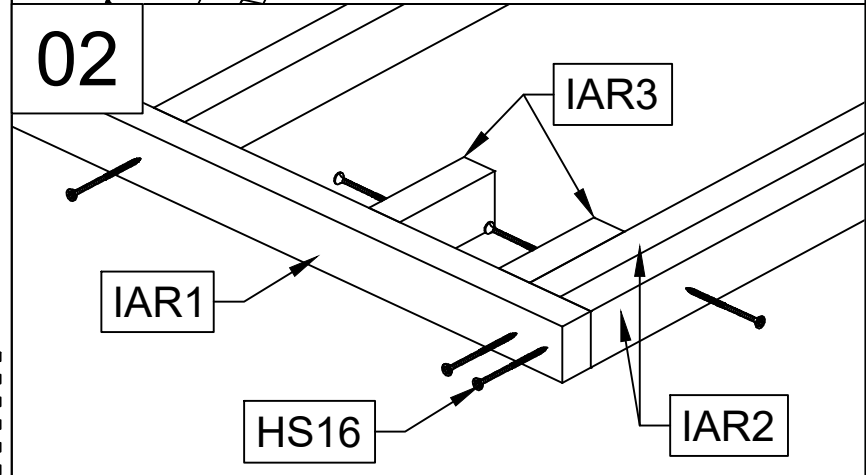
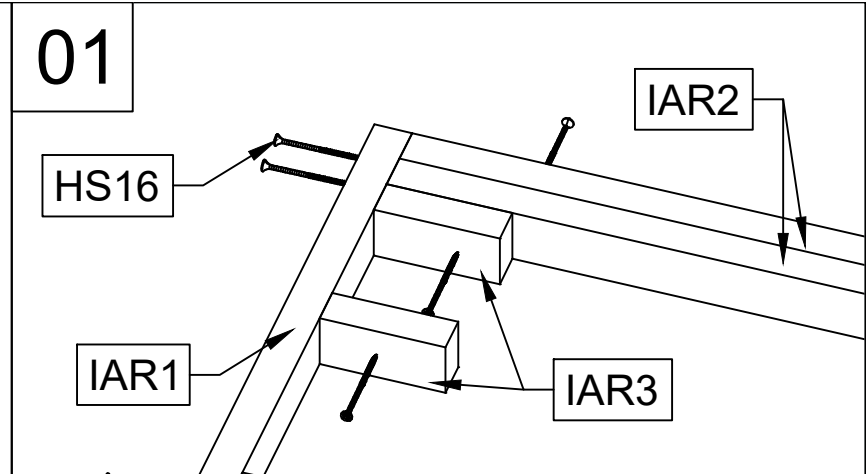
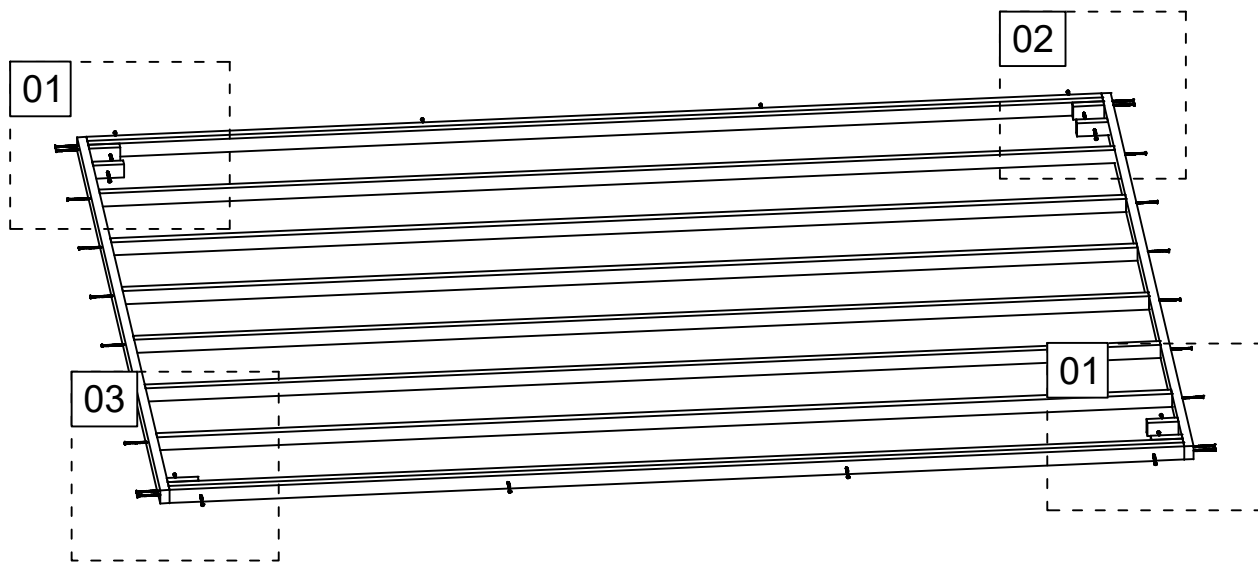

Art. Nr. 4426719

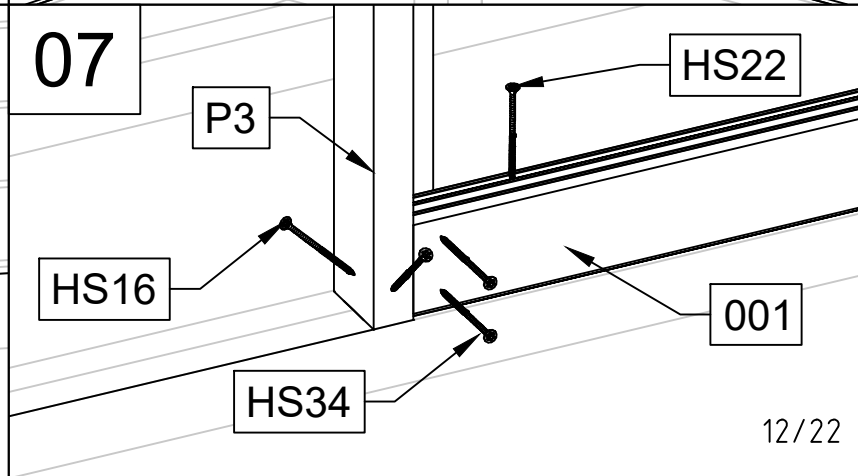
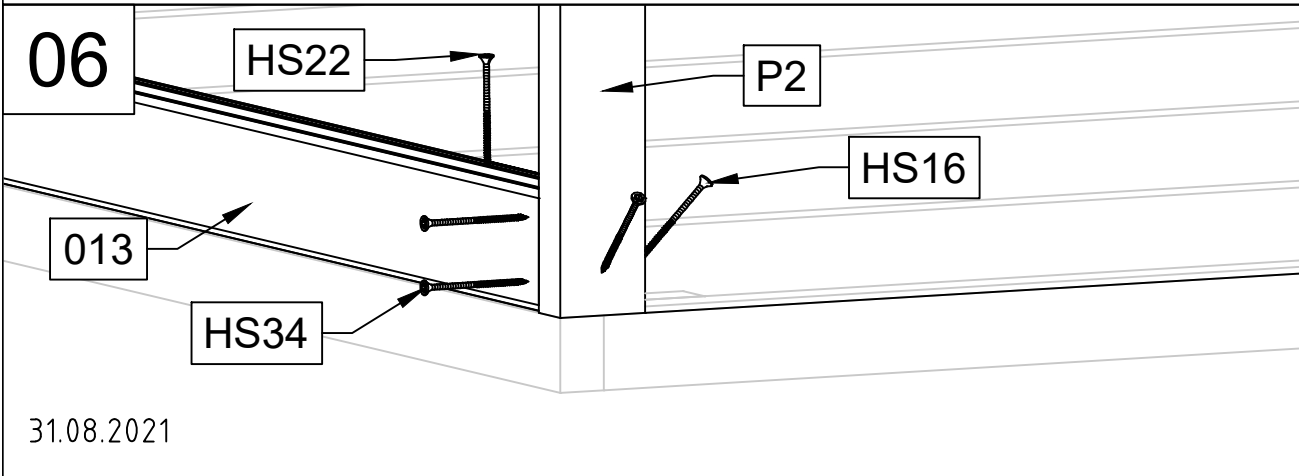
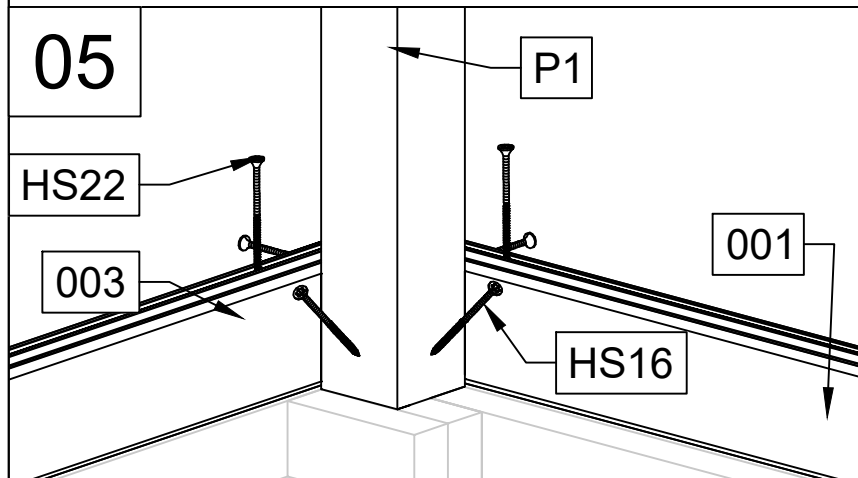
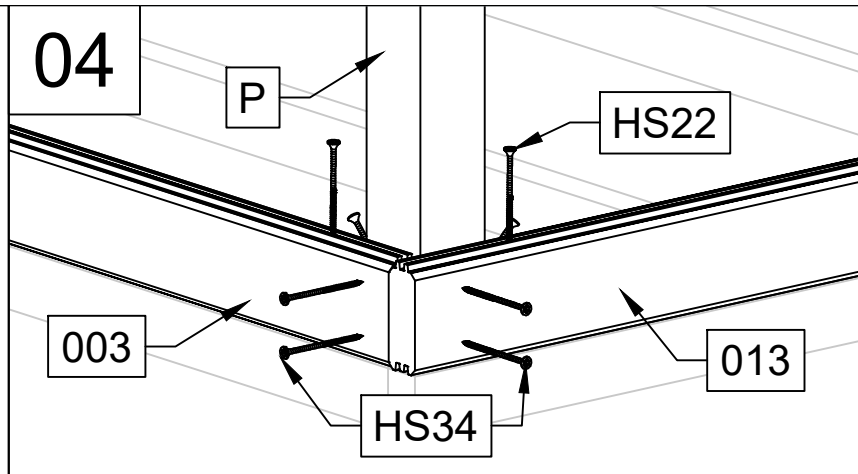
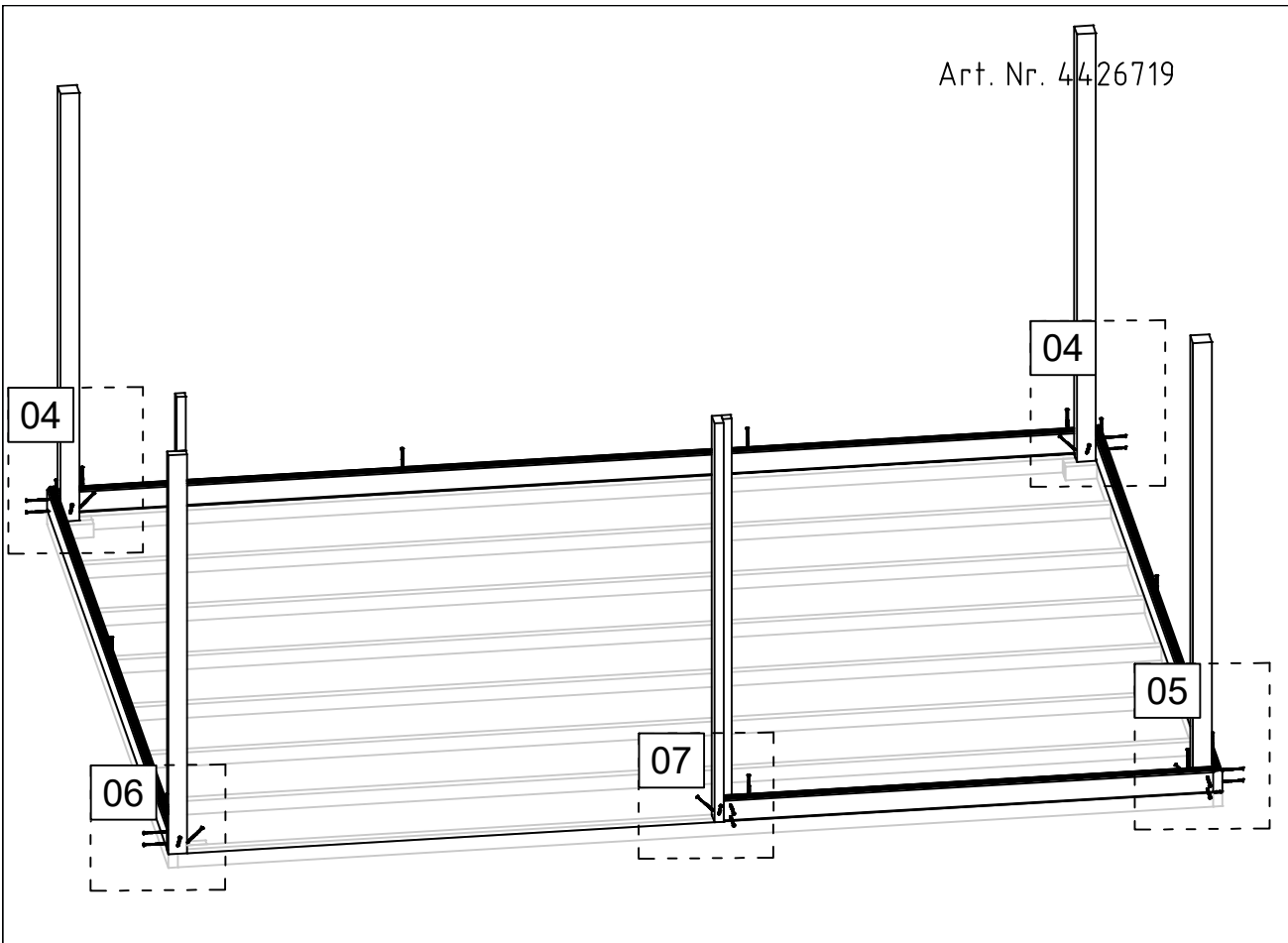

Art. Nr. 4426719

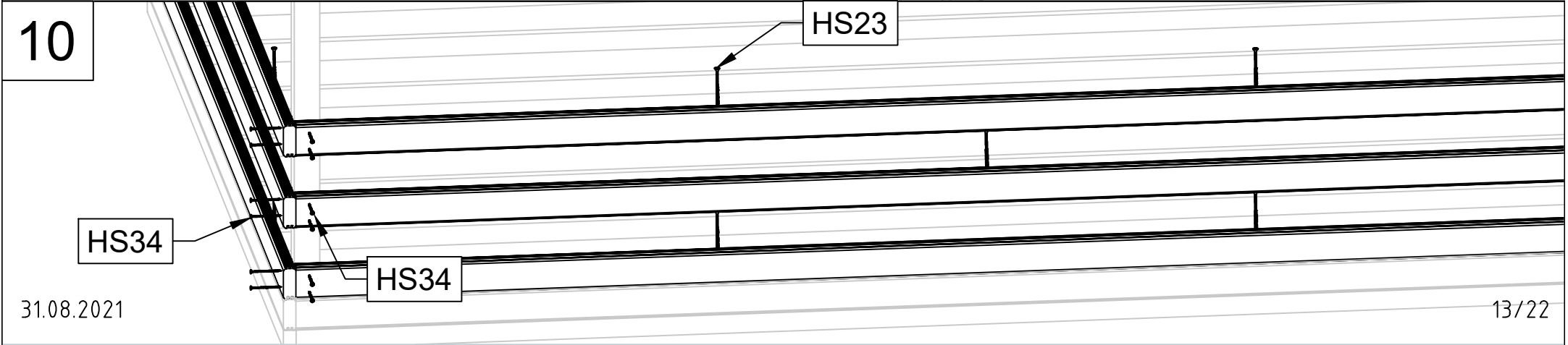
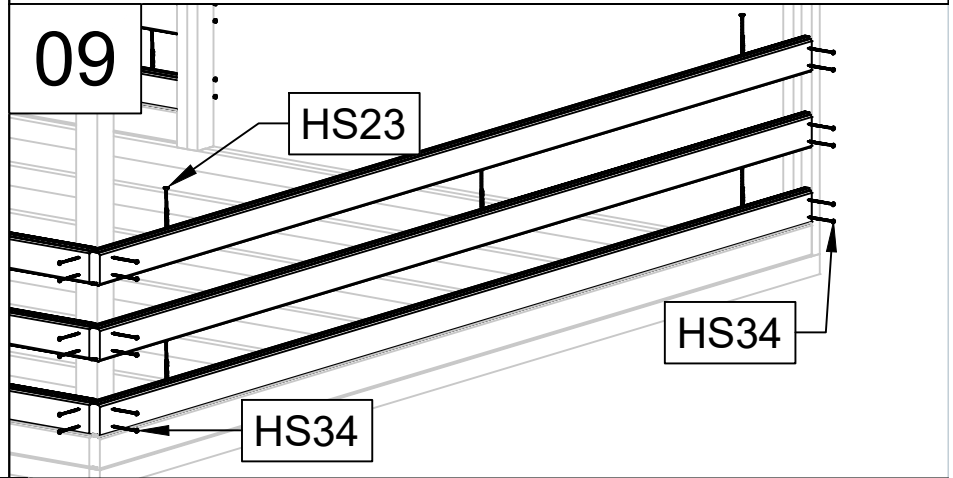
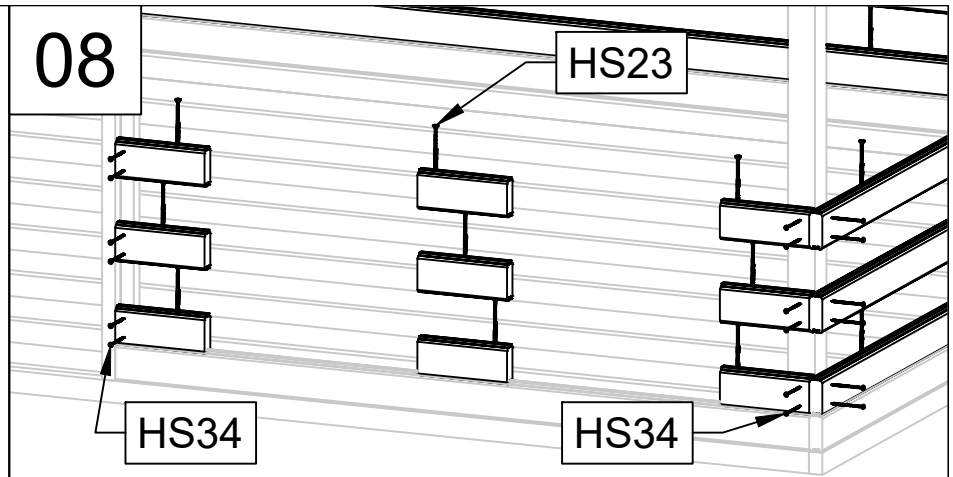
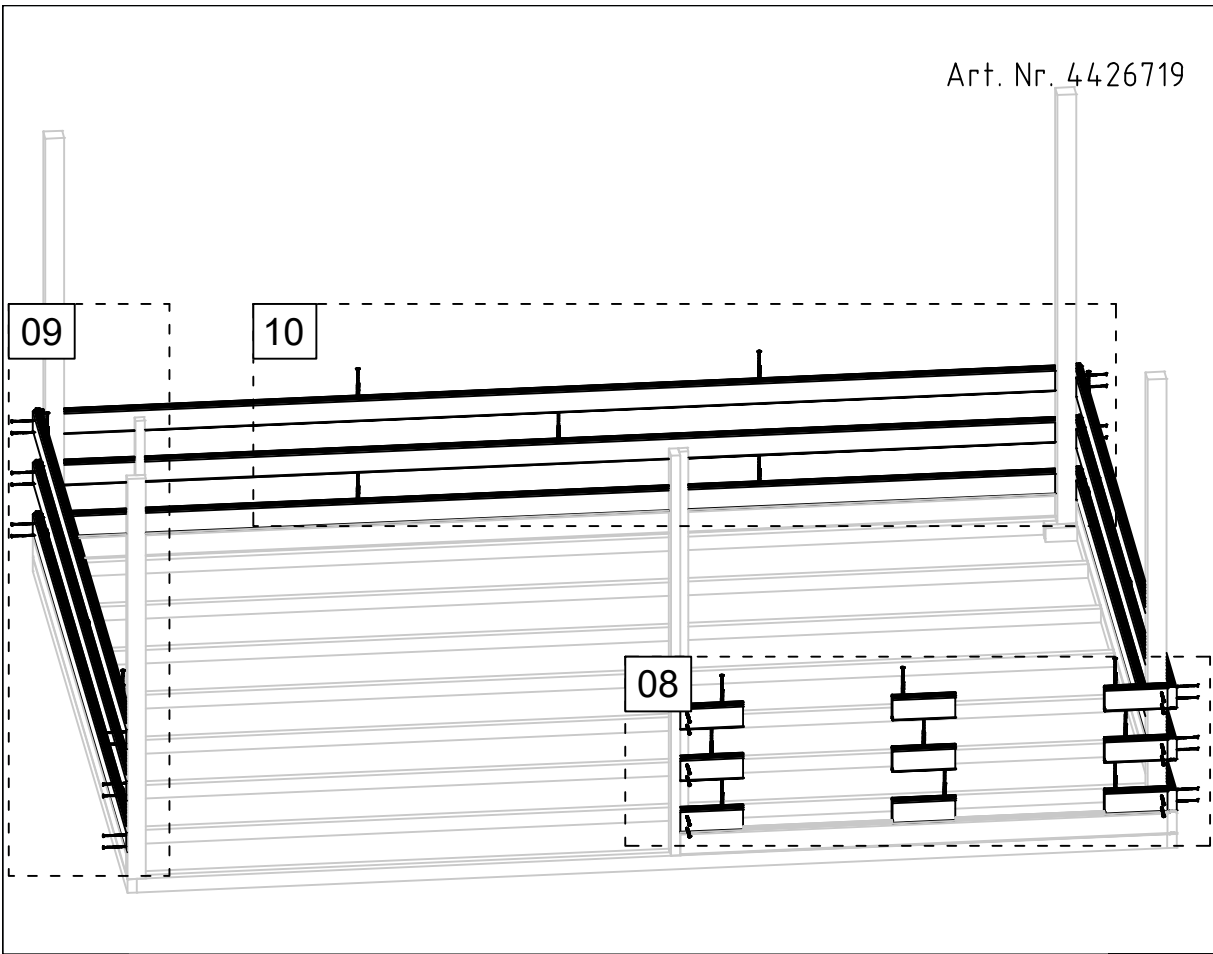

Art. Nr. 4426719

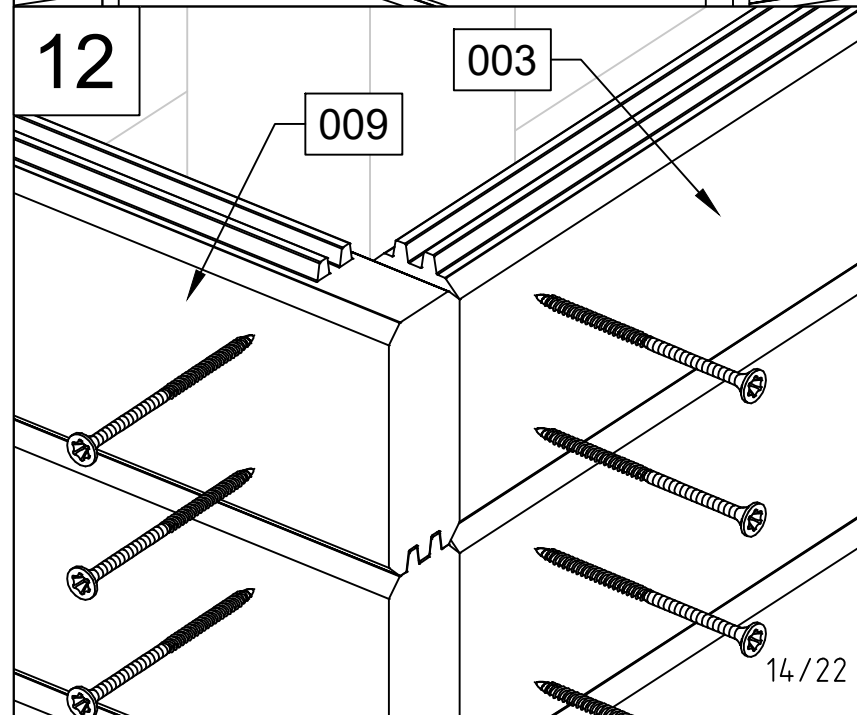
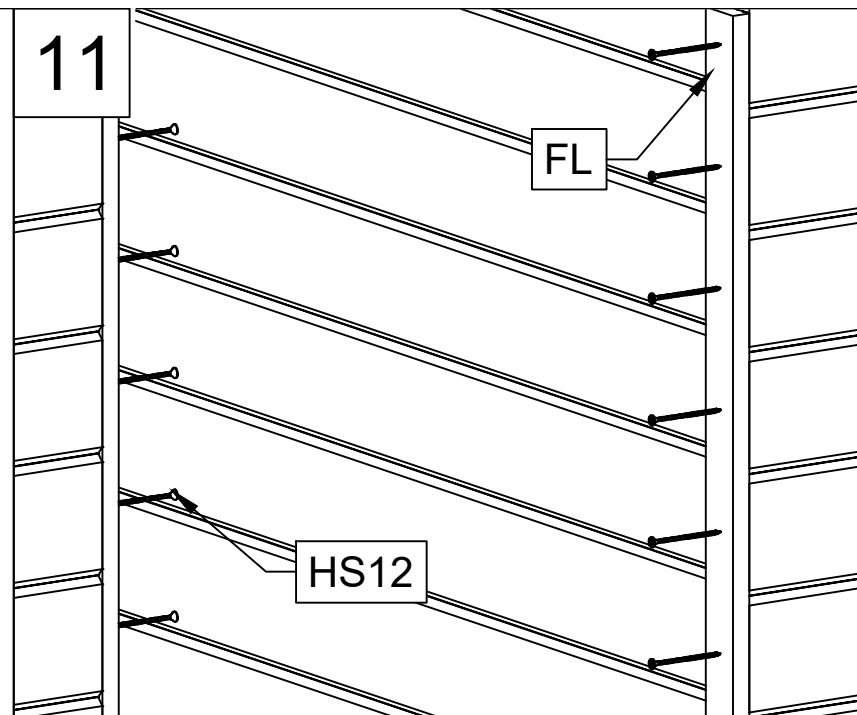

Art. Nr. 4426719

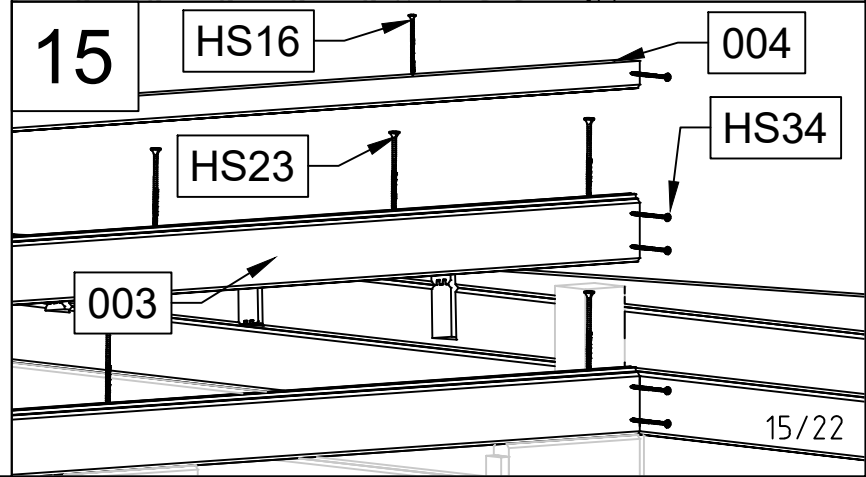
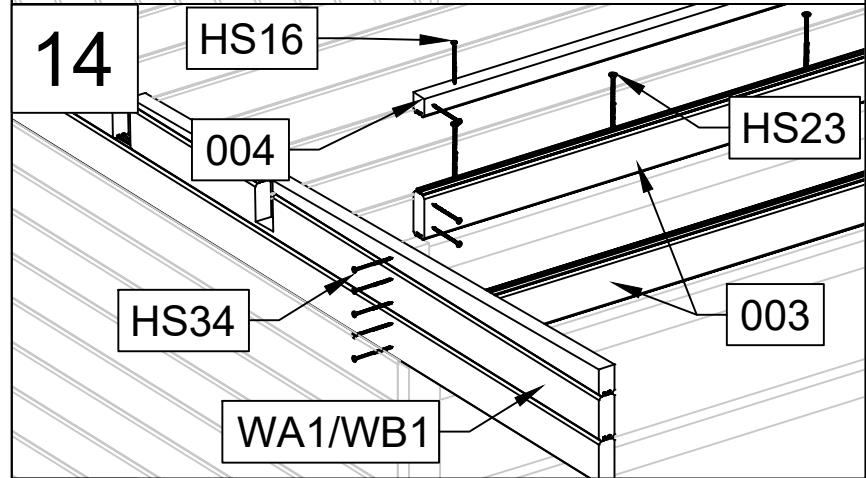
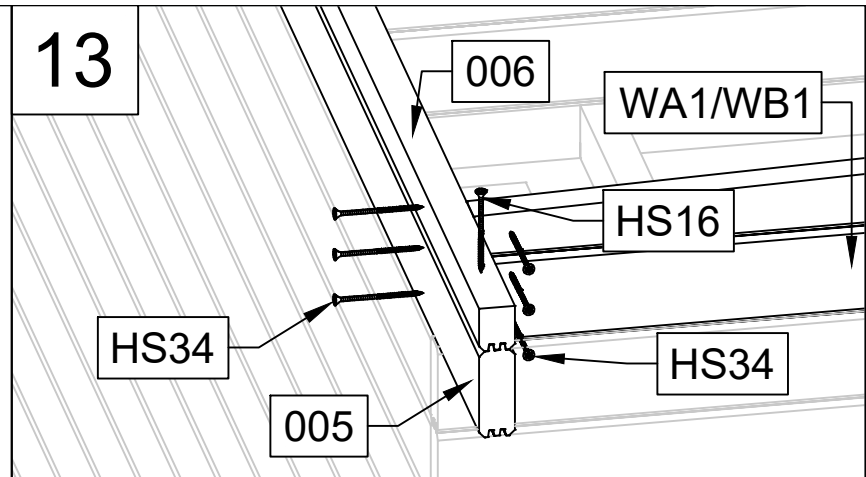
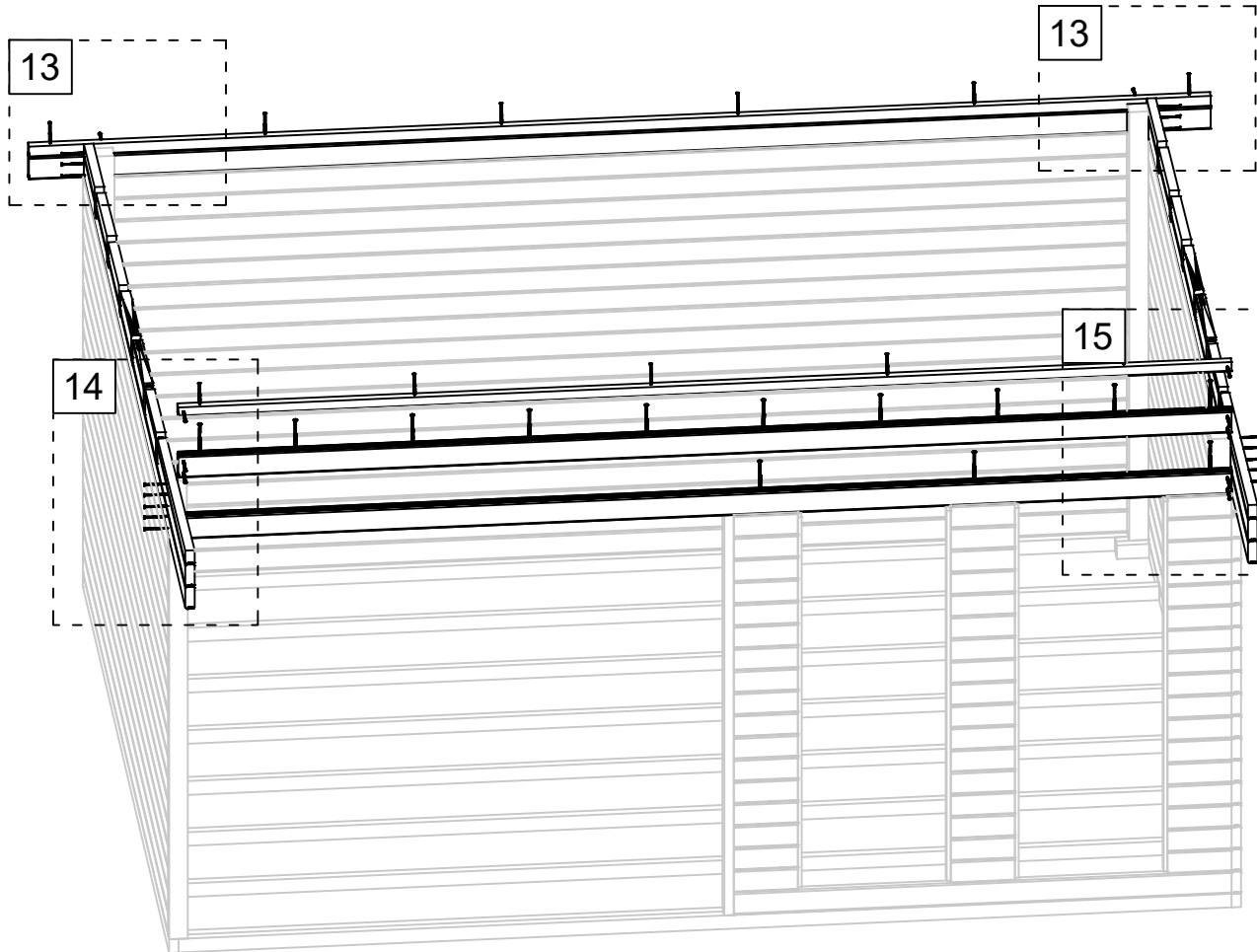

Art. Nr. 4426719

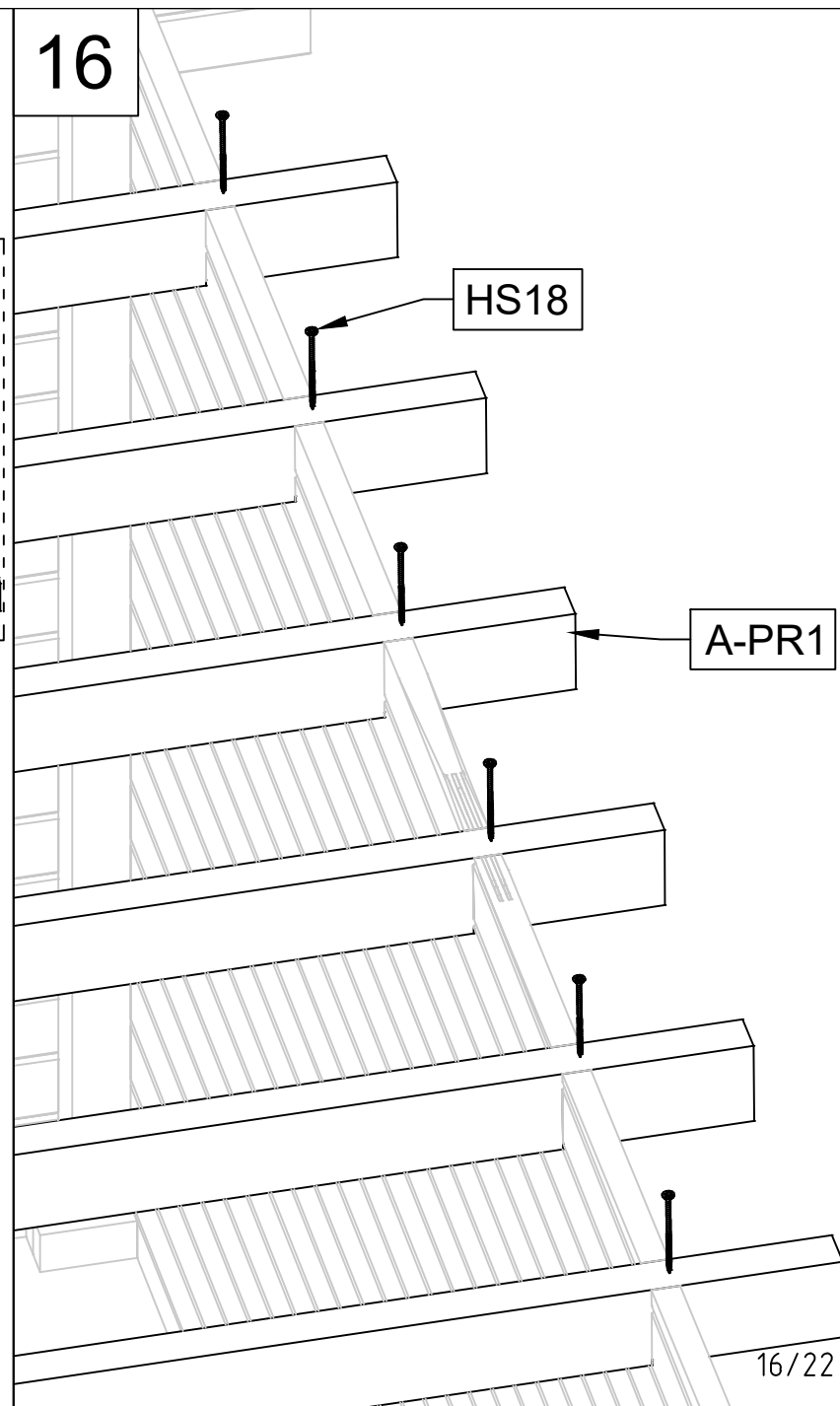
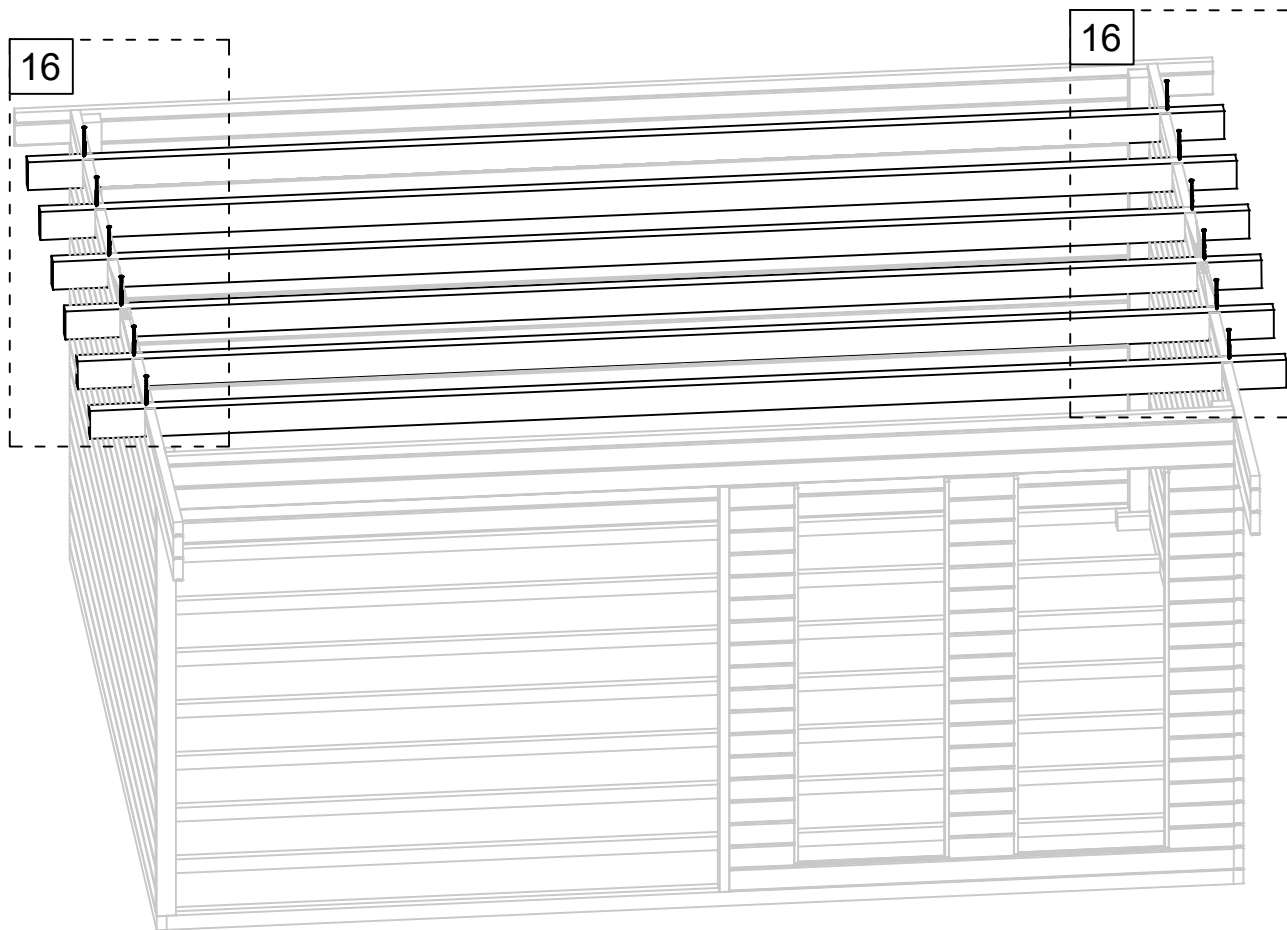

31.08.2021

16/22

Art. Nr. 4426719

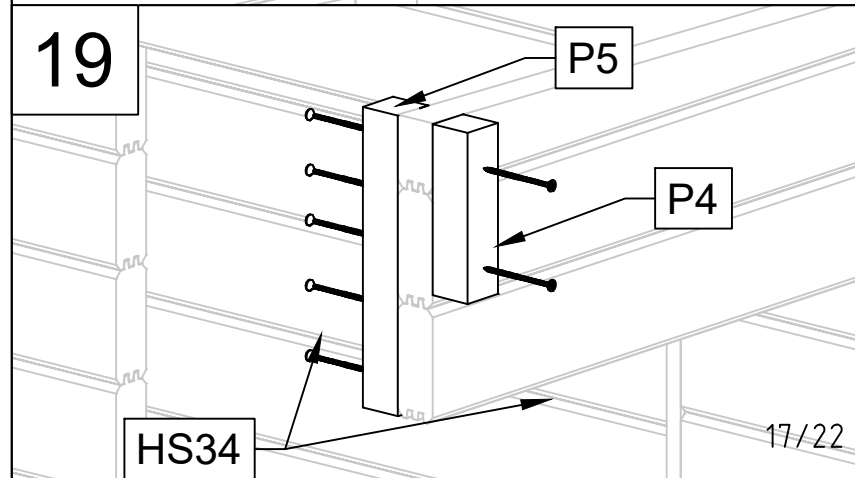
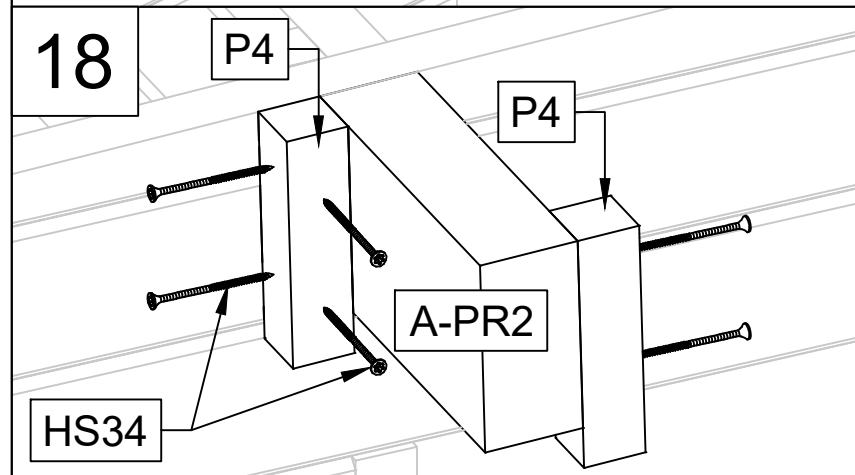
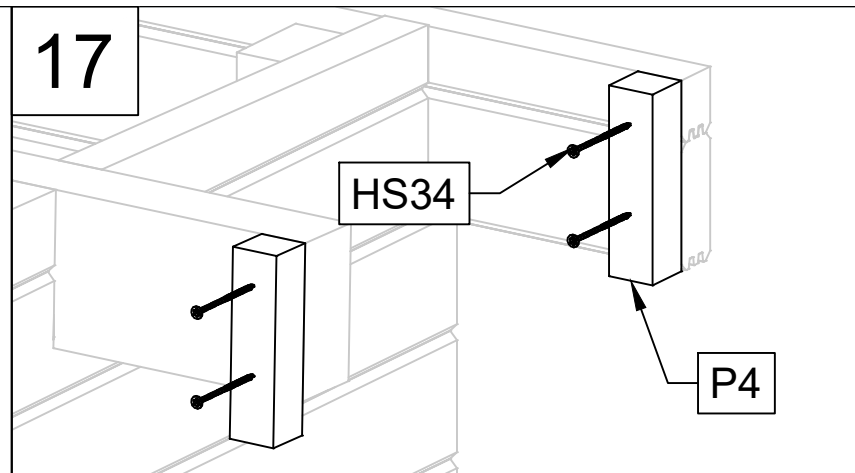
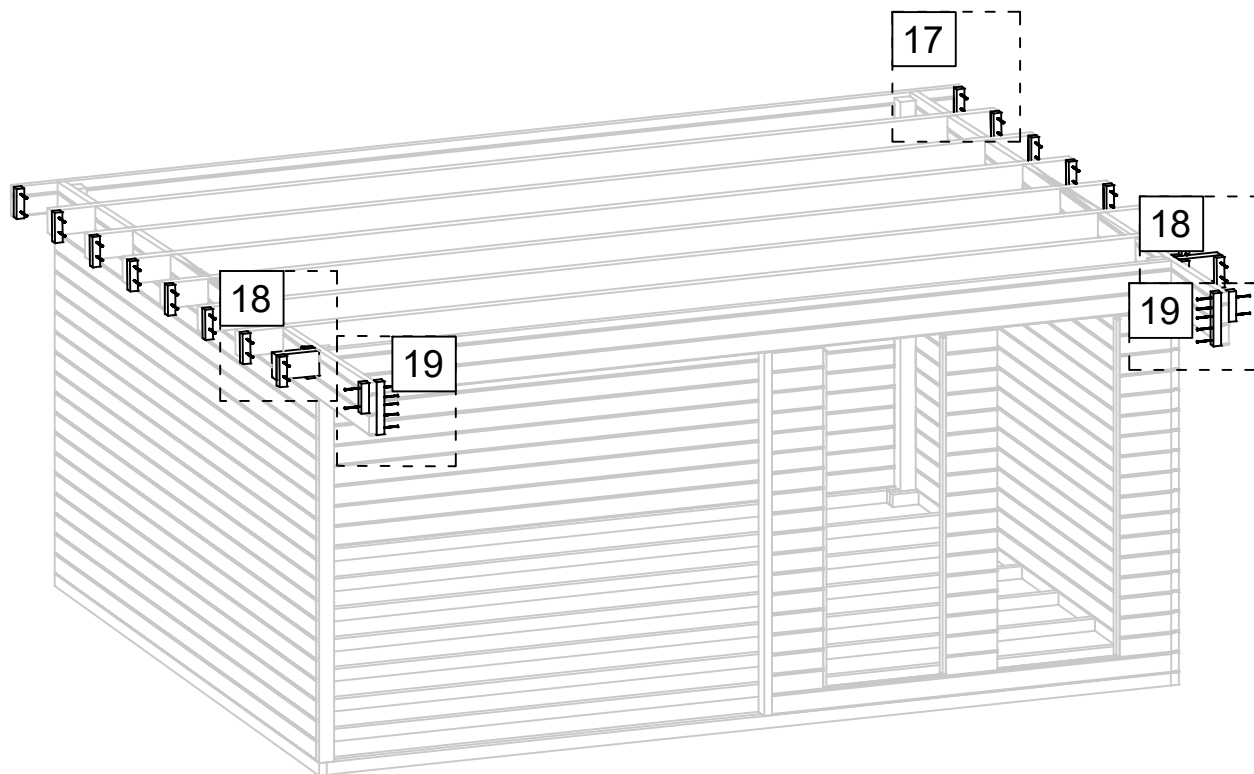

Art. Nr. 4426719

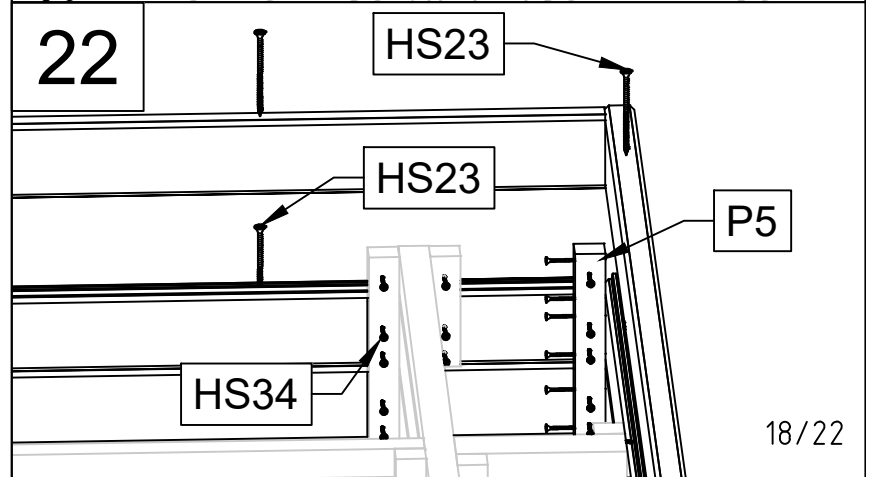
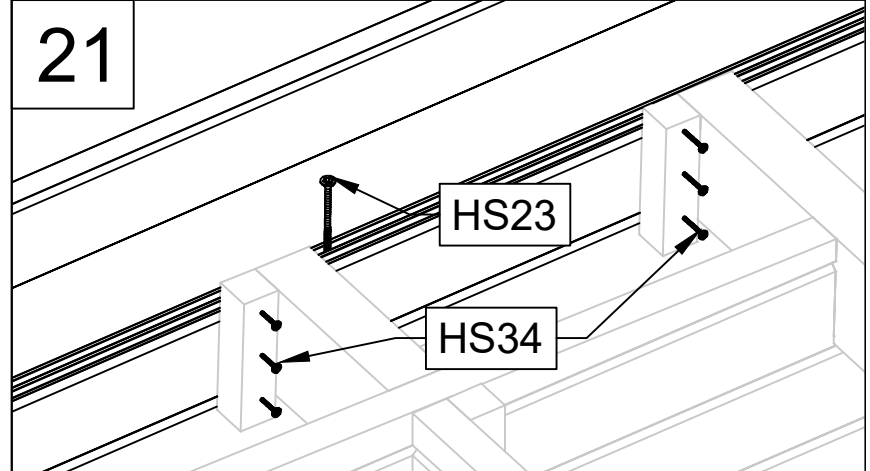
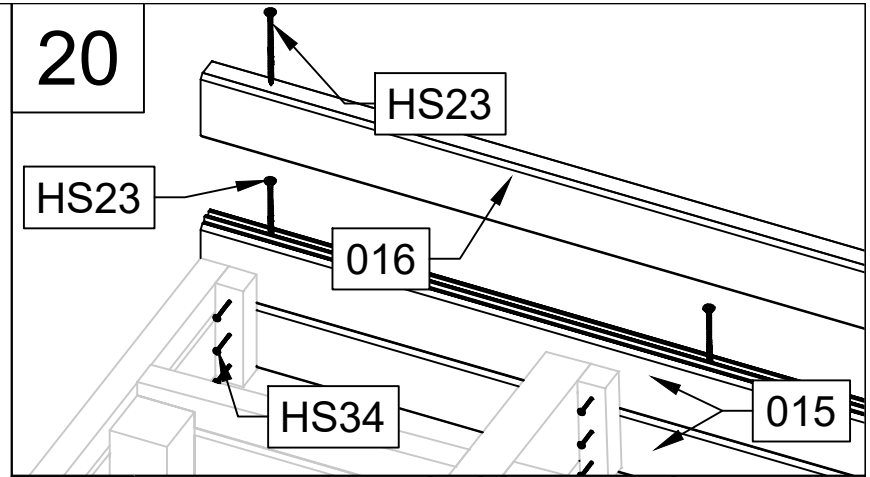
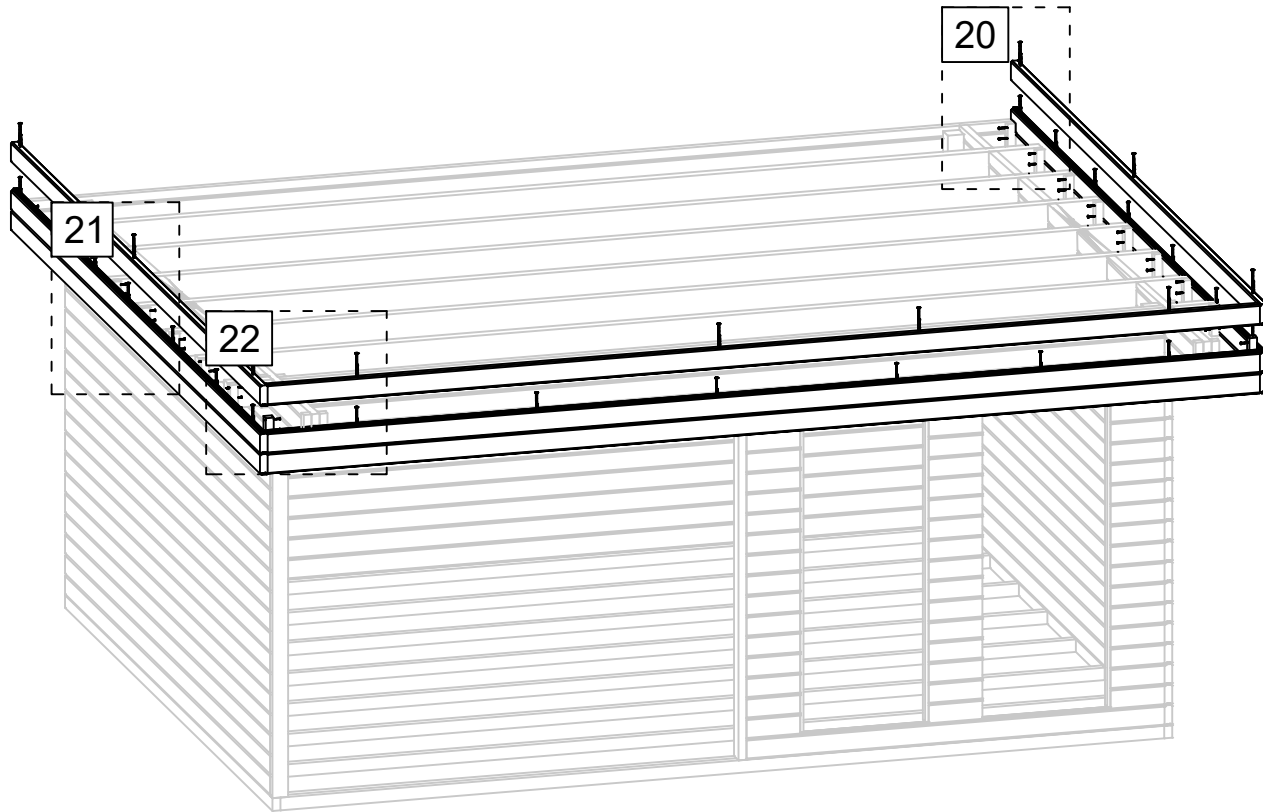

Art. Nr. 4426719

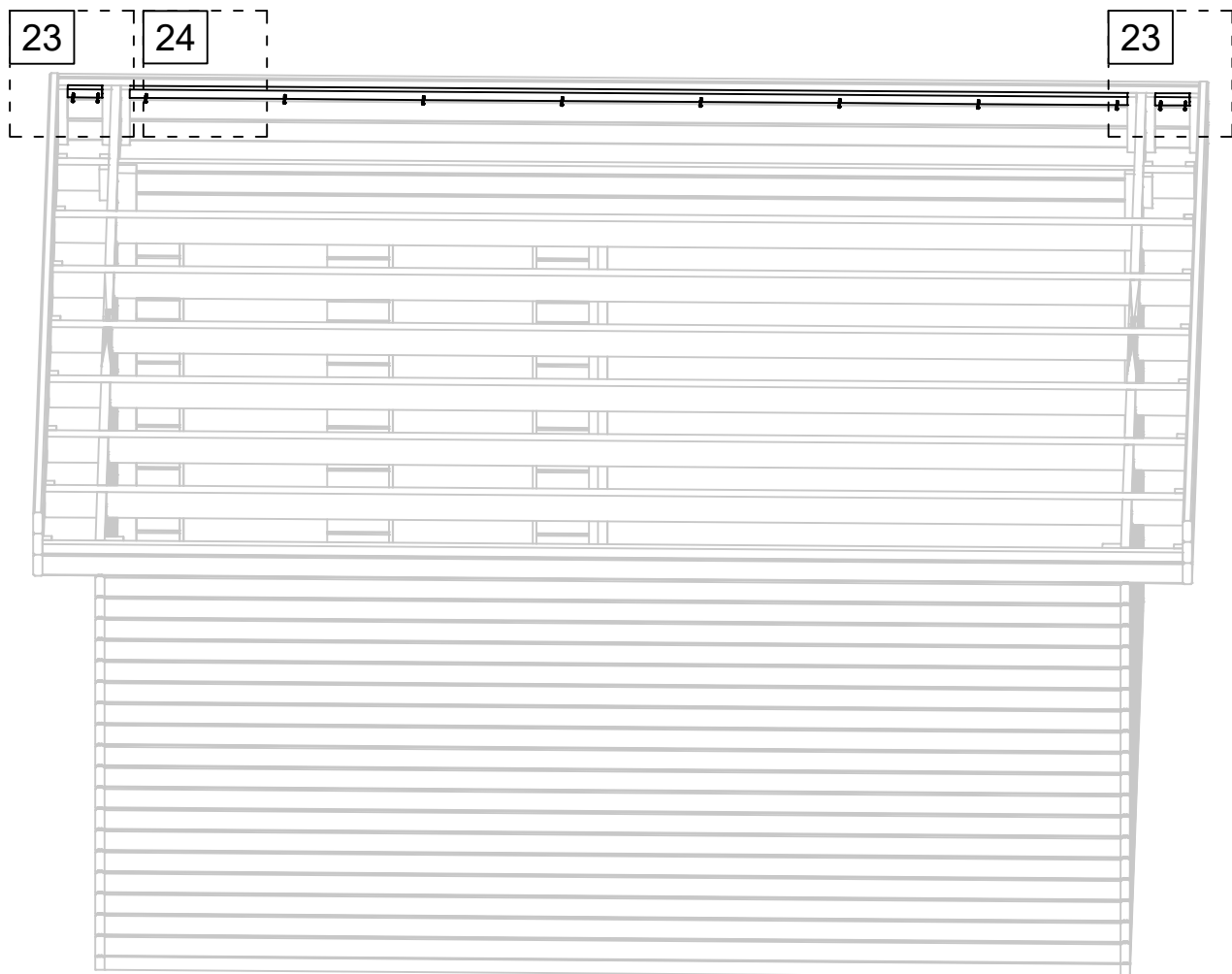

23

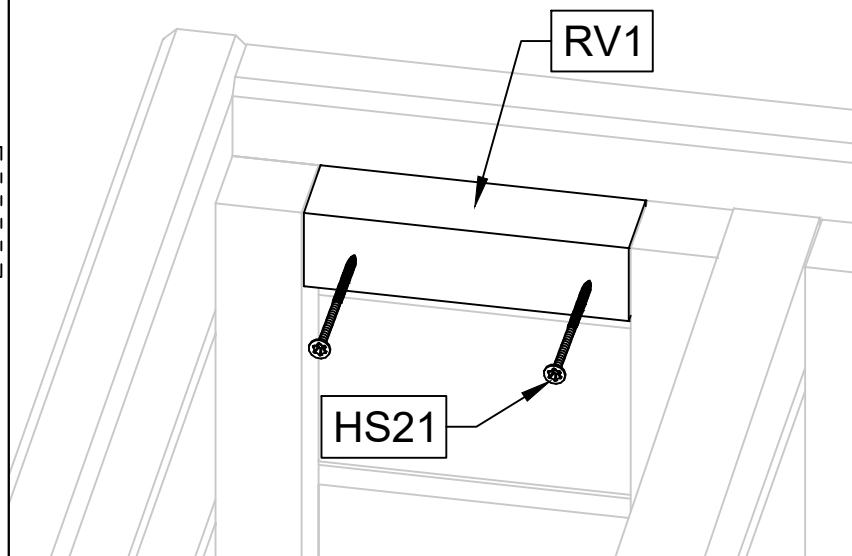

24

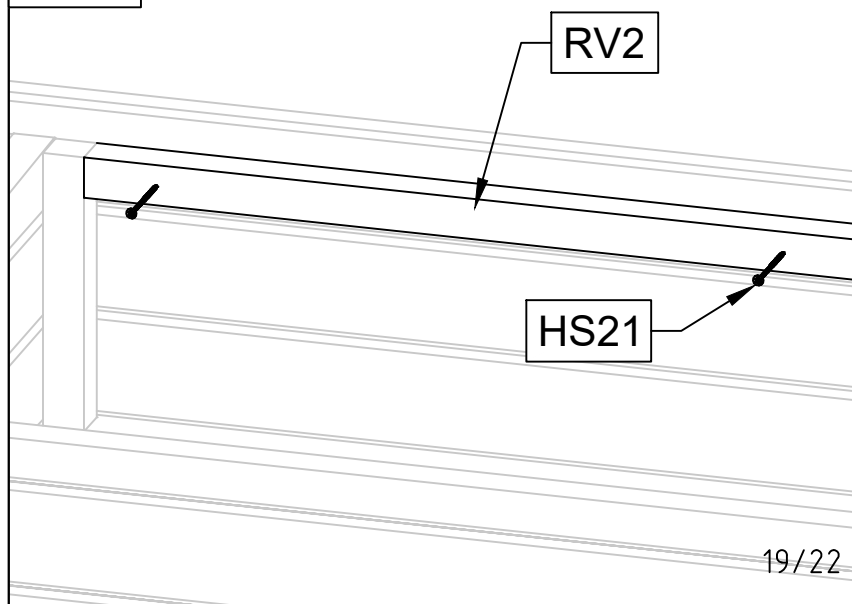

Art. Nr. 4426719

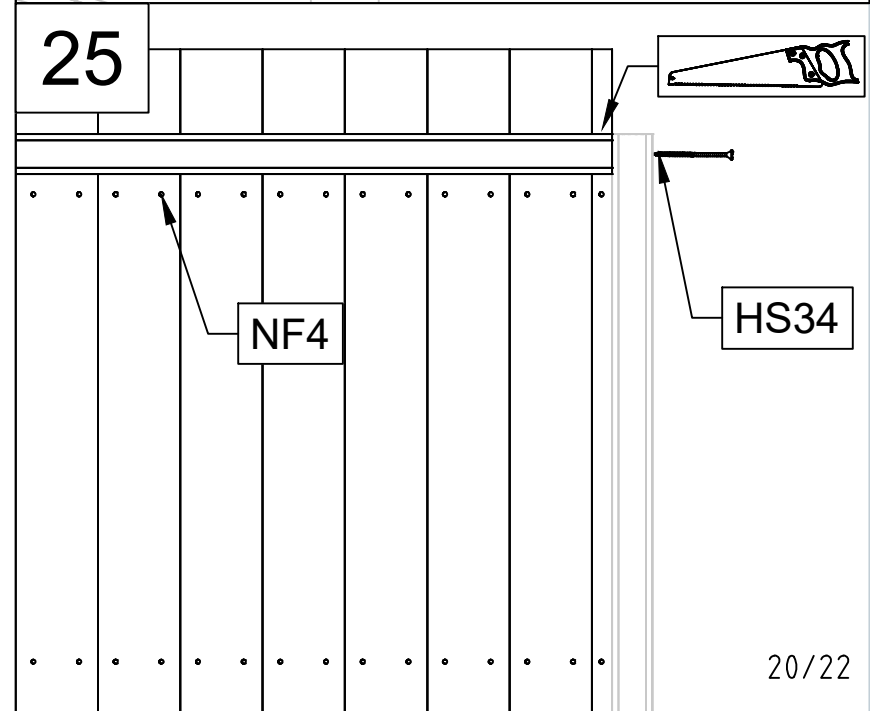
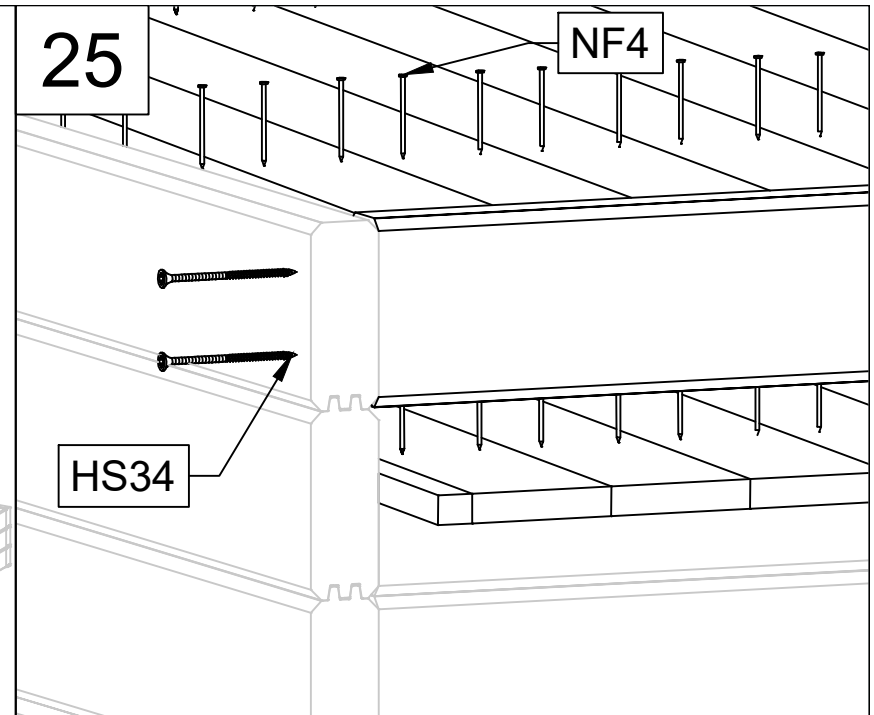
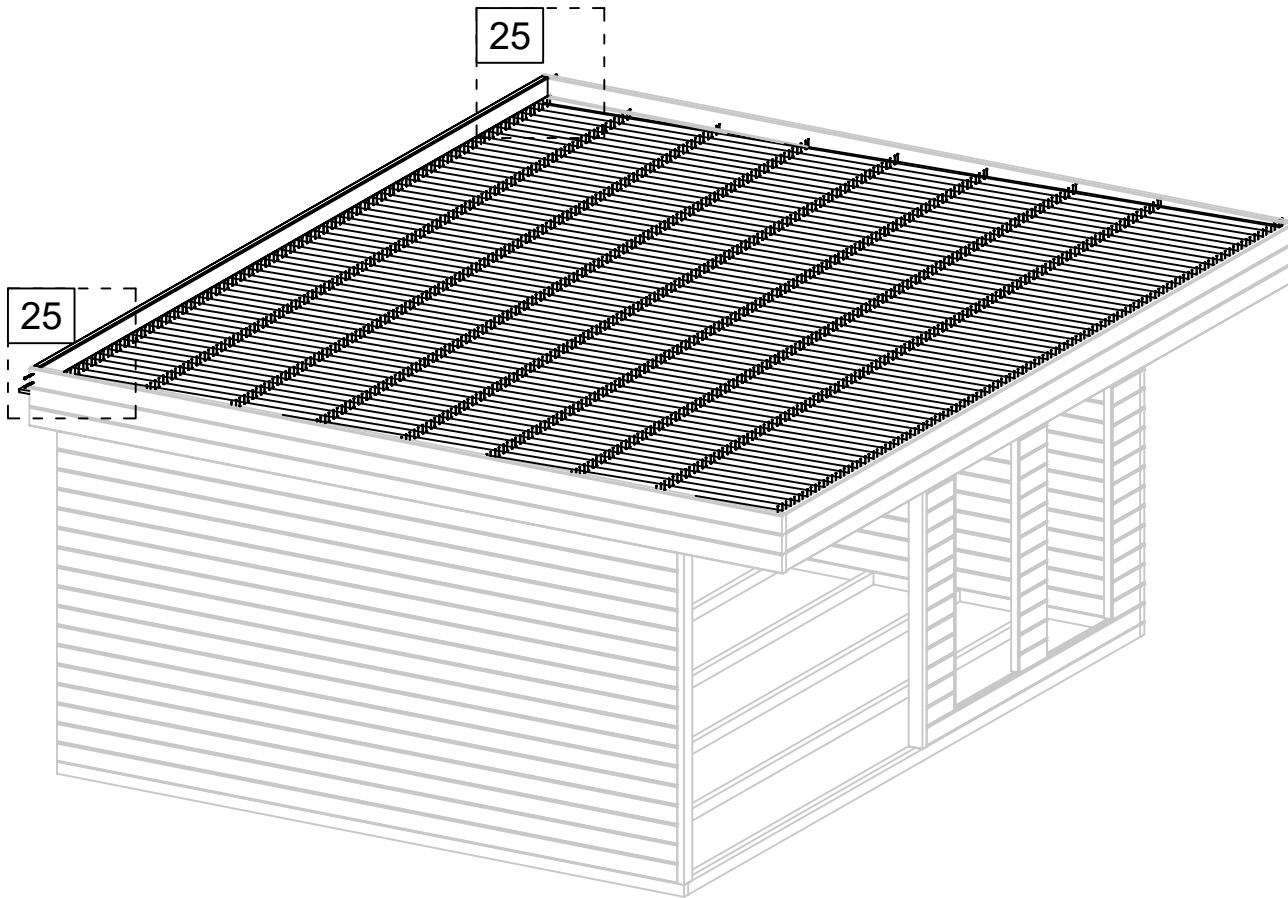

Art. Nr. 4426719

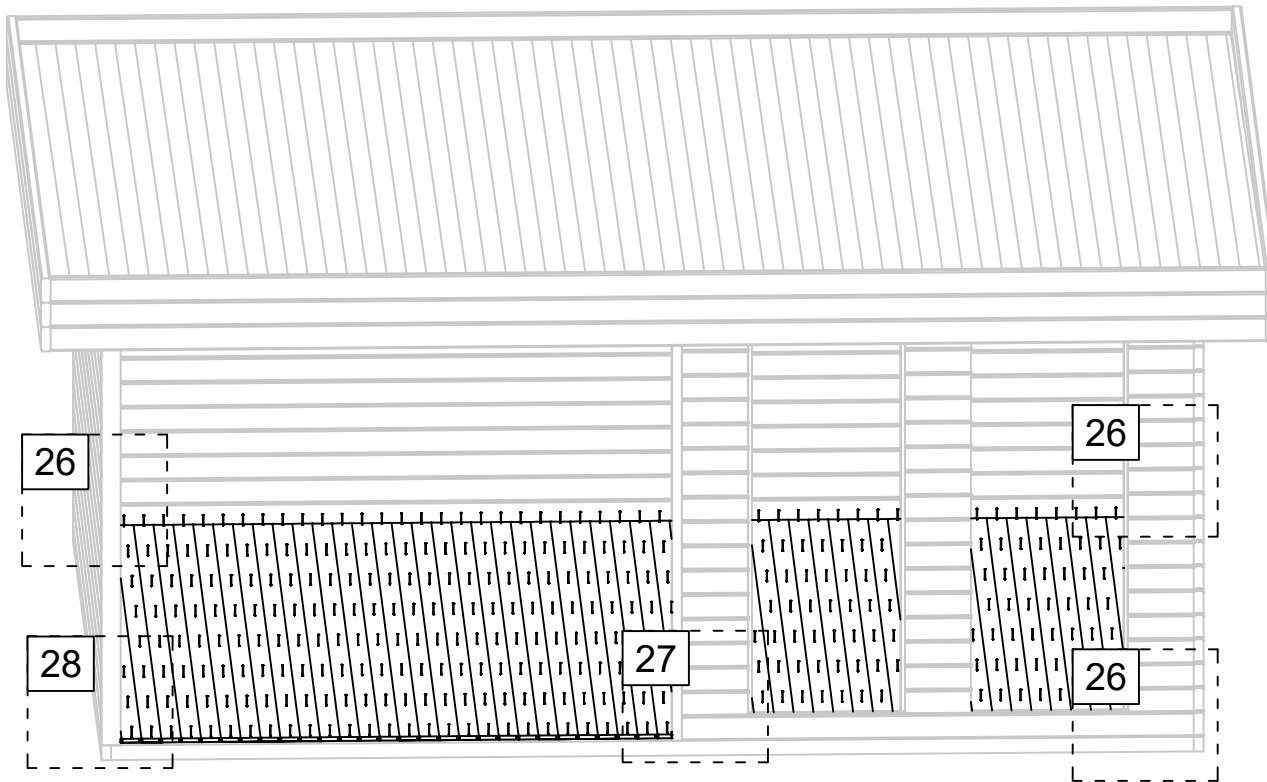

26

NF4

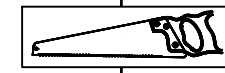

9

9

27

NF4

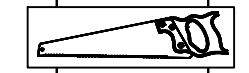

9,2

4,4

4,4

28

NF4

4,4

4,4

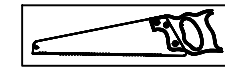

Art. Nr. 4426719

