

Brighton 44
Art. Nr. 4416902
1/11

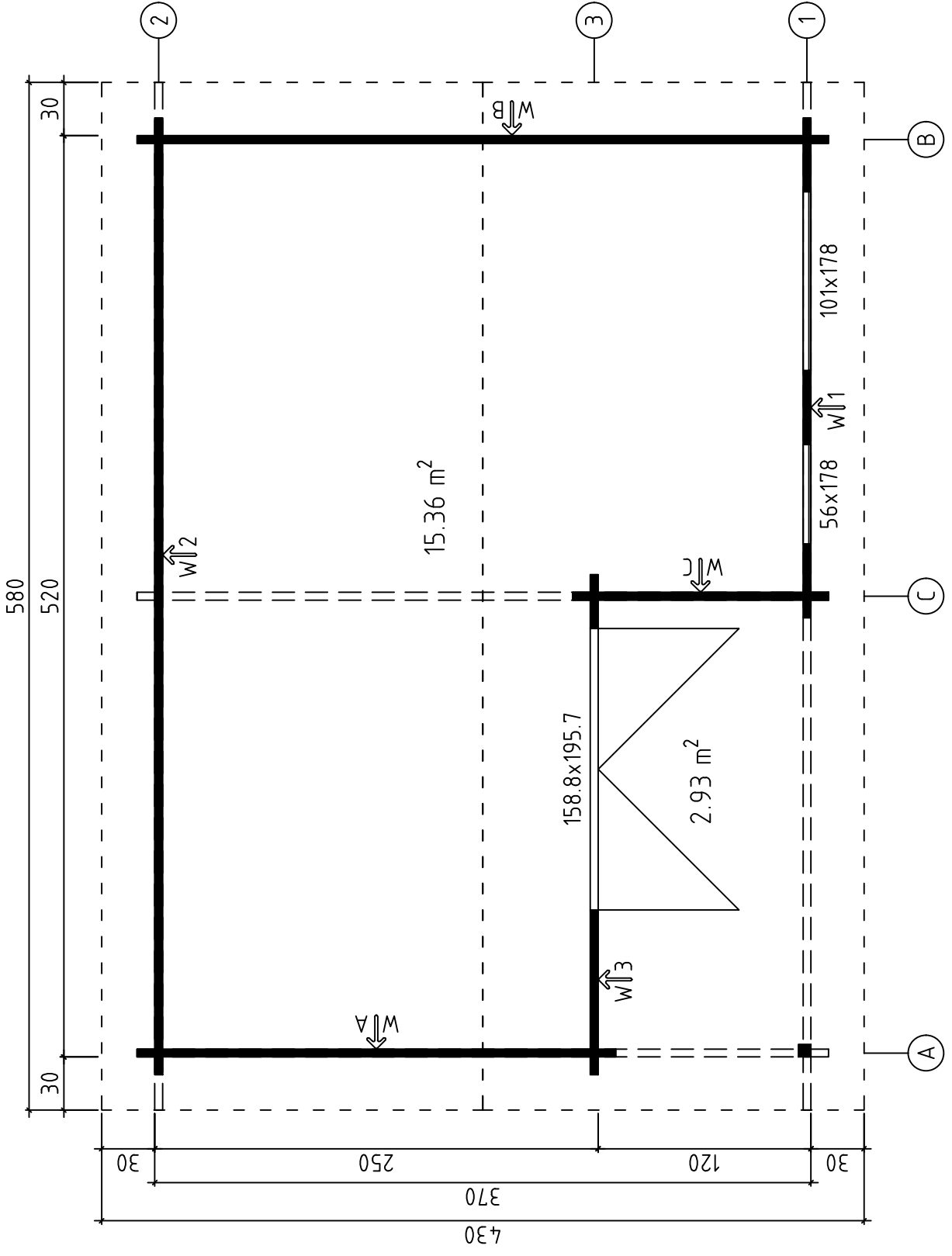

Art.Nr. 4416902

PLANRITNING - GRUNNPLAN - POHJAPIIRUSTUS



Art.Nr. 4416902
 GRUND - GRUNNMUR - FUNDAMENT - PERUSTUS

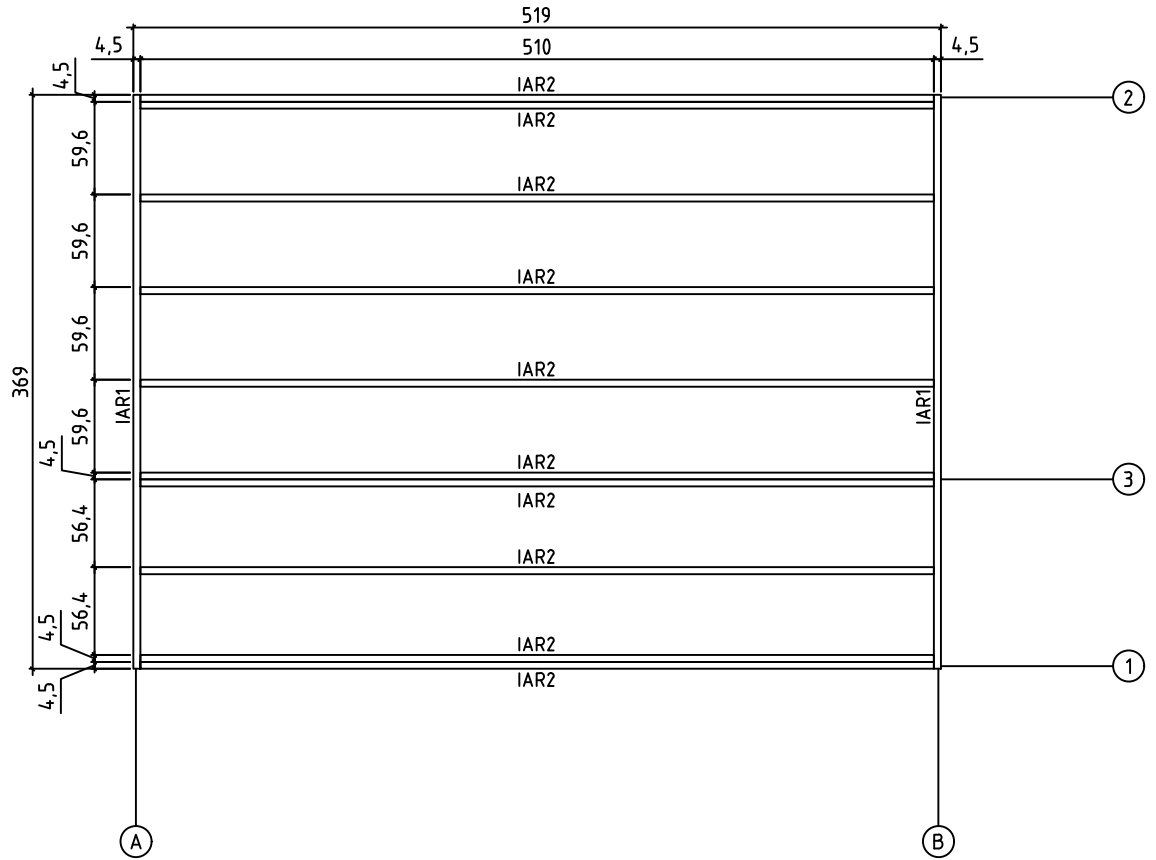

GOLVBRÄDOR - GULVBORD - GULVBRÆDDER - LATTIALAUDAT
 TERRASSBRÄDOR - TERRASSEBORD - TERRASSEBRÆDDER - TERASSILAUTA

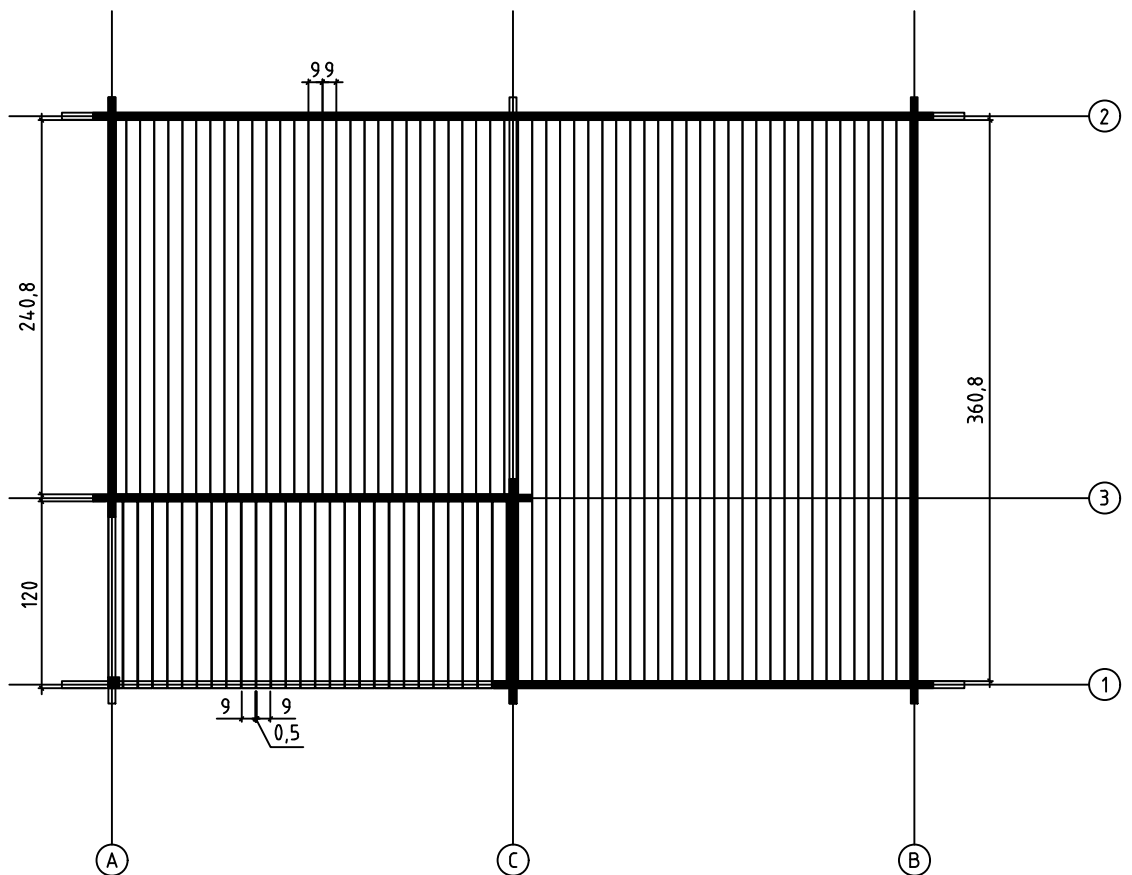

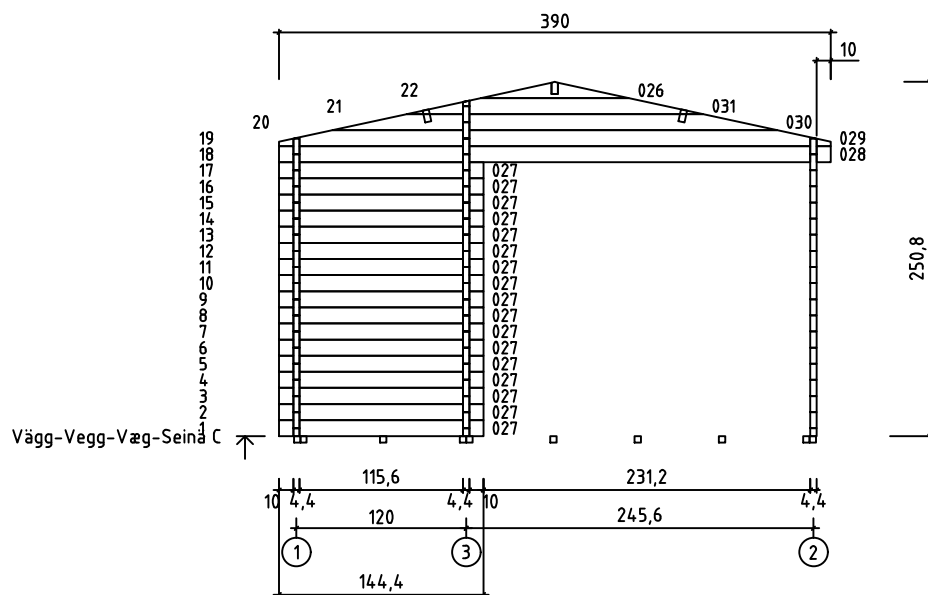
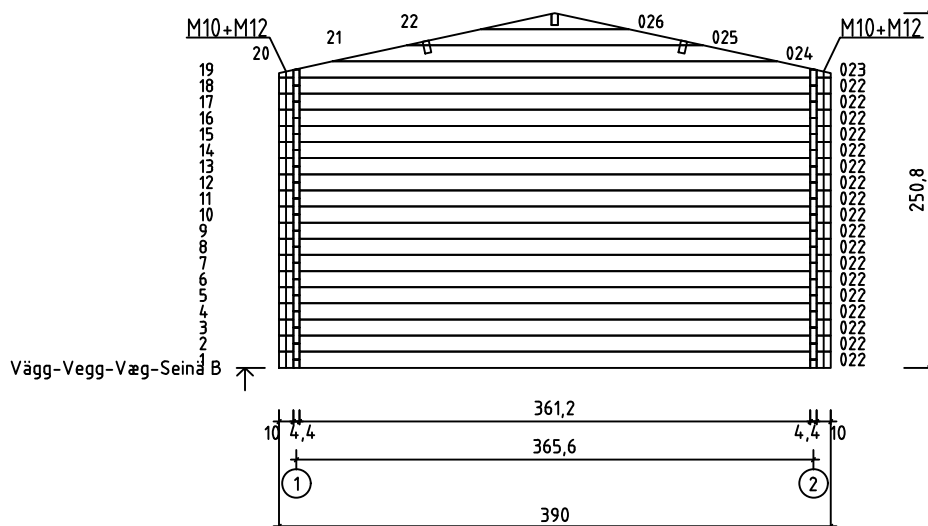
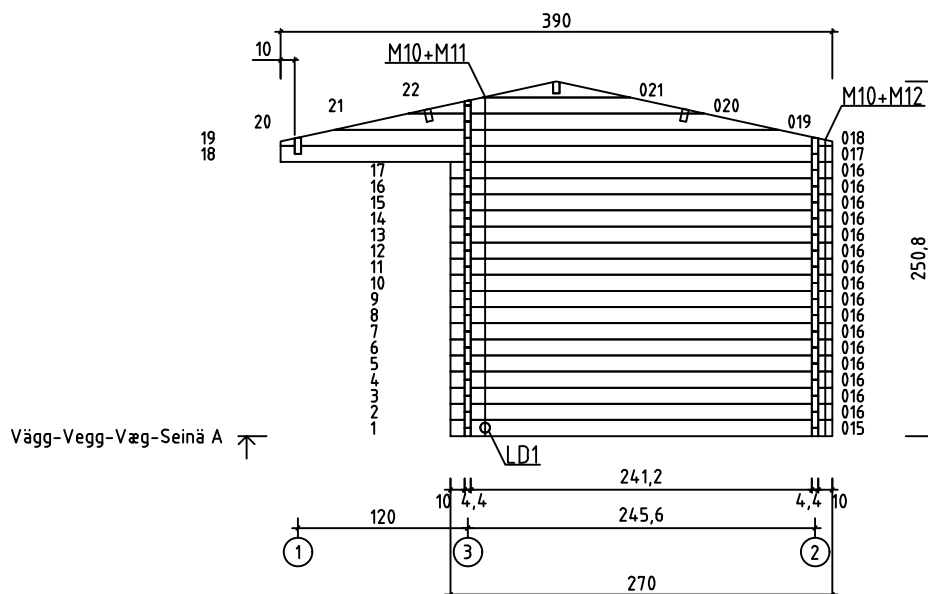

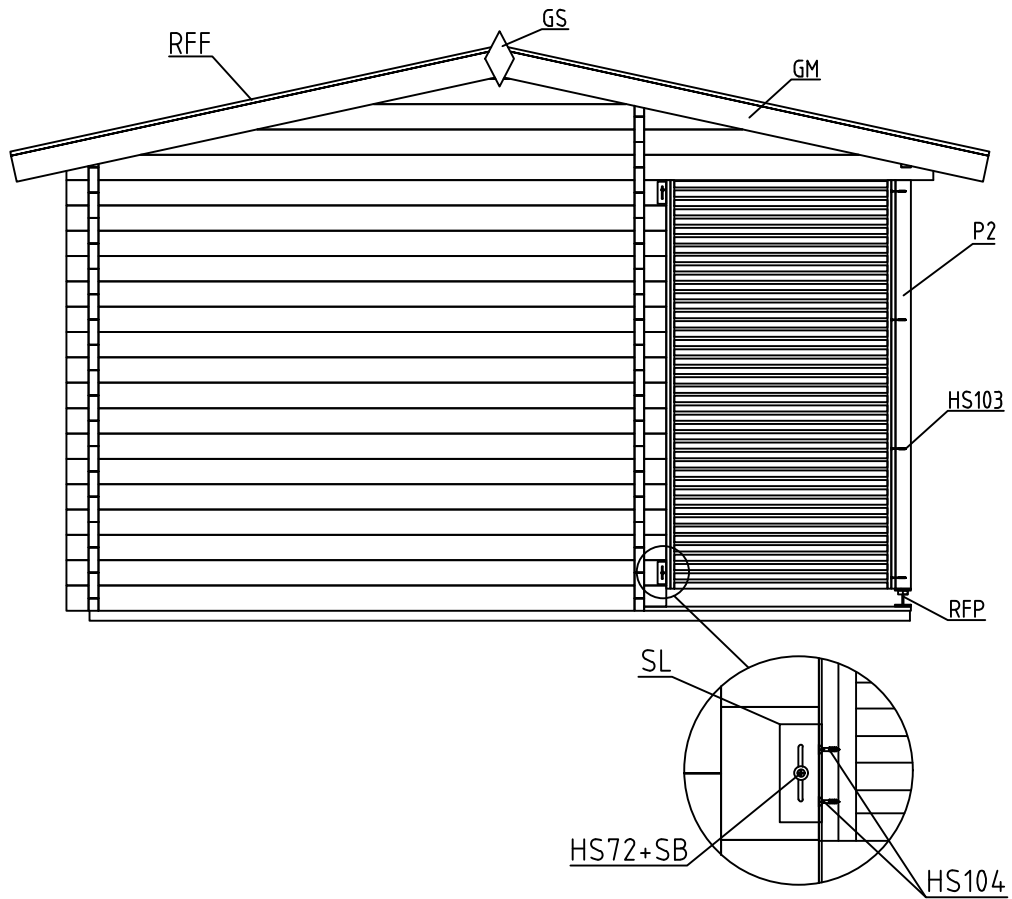



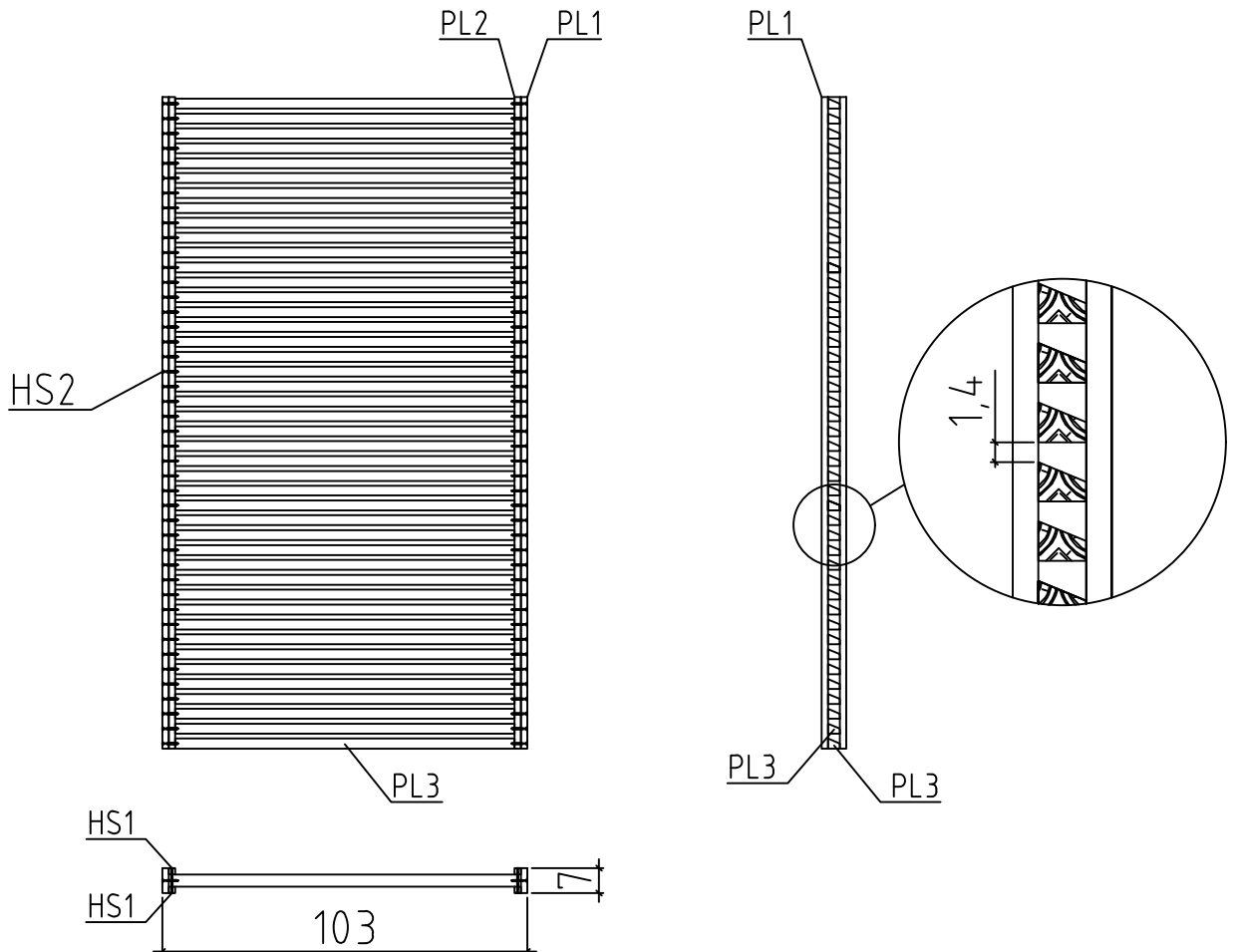

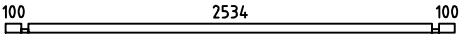
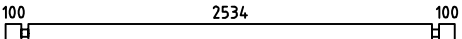

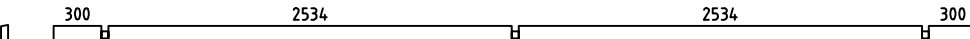
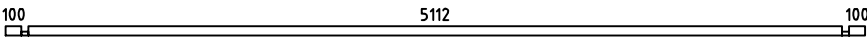
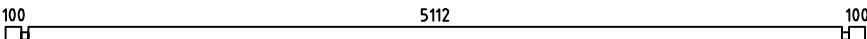
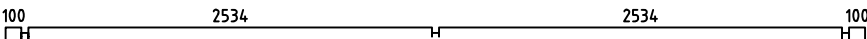
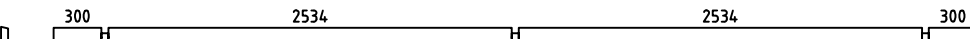
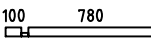

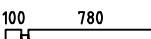

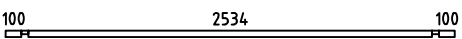
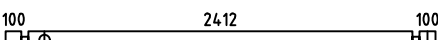
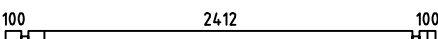
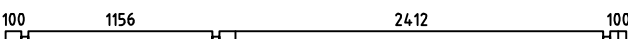
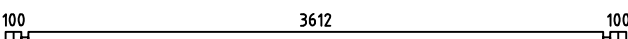
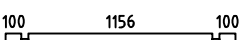
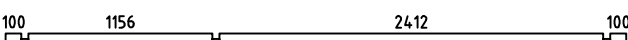
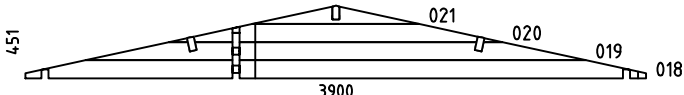
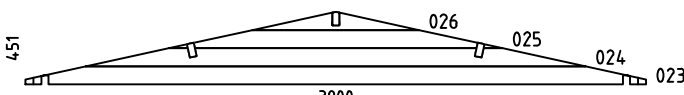



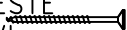
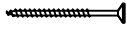
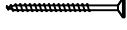
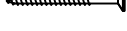

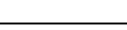
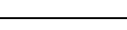
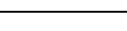
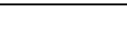



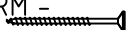
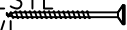
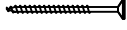



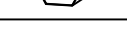
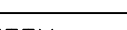
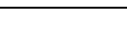

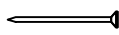

TERRASSRÄCKE - TERRASSEREKKVERK -
TERRASSEGELÄNDER - TERRASSIKAIDE

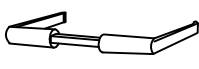

Pos	16.12.2016 Delförteckning - Liste over deler - Styklister - Osaluettelo Art.Nr. 4416902	8/11	Q.	P (mm)	L (mm)
001			1	44x57	2822
002			4	44x114	2822
003			32	44x114	416
004			16	44x114	416
005			1	44x120	5800
006			1	44x57	5400
007			16	44x114	5400
008			1	44x114	5400
009			1	44x120	5800
010			1	44x57	924
011			1	44x57	300
012			17	44x114	924
013			17	44x114	300
014			1	44x39	2822
015			1	44x114	2700
016			16	44x114	2700
017			1	44x114	3900
022			18	44x114	3900
027			17	44x114	1444
028			1	44x114	3900
WA-1			1		
WB-1			1		

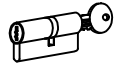
Pos	16.12.2016 Delförteckning - Liste over deler - Styklister - Osaluettelo Art.Nr. 4416902	9/11	Q.	P (mm)	L (mm)
WC-1			1		
IAR2	GRUND - GRUNNMUR - FUNDAMENT - PERUSTUS 		10	45x45	5100
IAR1	GRUND - GRUNNMUR - FUNDAMENT - PERUSTUS 		2	45x45	3690
PR1	TÅKASAR - TAKBJELKE - TAGBJÆLKE - KATTO-ORRET 300 2534 2534 300 		1	44x140	5800
A-PR1	TÅKASAR - TAKBJELKE - TAGBJÆLKE - KATTO-ORRET 300 2534 2534 300 		2	44x140	5800
	GOLVBRÄDOR - GULVBORD - GULVBRÆDDER - LATTIALAUDAT 		29	90x18	3608
	GOLVBRÄDOR - GULVBORD - GULVBRÆDDER - LATTIALAUDAT 		28	90x18	2408
	TERRASSBRÄDOR - TERRASSEBORD - TERRASSEBRÆDDER - TERASSILAUTA 		28	90x19	1200
	TAKBRÄDE - TAKBORD - TAGBRÆDDER - KATTOLAUTA 		130	90x18	2200
	GOLVLÄKT - GULVLIST - GULVLISTE - JALKALISTA 			18x18	17.43
RFF	TAKLÄKT - LIST FOR TAKPAPP - TAGPAPLISTE - KATTOHUOPALISTA 		4	18x58	2250
M12	GÄNGAD STÅNG M10 - GJENGESTANG M10 - GEVINDSTANG M10 - KIERRETANKO M10 		3		125
M11	GÄNGAD STÅNG M10 - GJENGESTANG M10 - GEVINDSTANG M10 - KIERRETANKO M10 		1		340
M10	GÄNGAD STÅNG M10 - GJENGESTANG M10 - GEVINDSTANG M10 - KIERRETANKO M10 		4		2000
PL1	LIST TILL TERRASSRÄCKE - LIST FOR TERRASSEREKKVERK - LÆGTE TIL TERRASSEGELÆNDER - TERASSIKAITEEN LISTA 		4	18x18	1839
PL2	LIST TILL TERRASSRÄCKE - LIST FOR TERRASSEREKKVERK - LÆGTE TIL TERRASSEGELÆNDER - TERASSIKAITEEN LISTA 		2	18x70	1839
PL3	LIST TILL TERRASSRÄCKE - LIST FOR TERRASSEREKKVERK - LÆGTE TIL TERRASSEGELÆNDER - TERASSIKAITEEN LISTA 		44	28x34	994
P2	STOLPE - SØYLE - STOLPE - PILARI 		1	70x70	1896
	TAKFOTSINKLÄDNAD - SPEILBORD - STERNBRÆT - RÄYSTÄSLAUTA 		4	18x90	2900
	TAKFOT - FORSTERKNING AV TAKFORKANT - TAGKANTSFORSTÆRKNING - RÄYSTÄSLISTA 		4	28x34	2900
GM	VINDBRÄDE - VINDSKI - VINDSKEDE - KAAPELILAUTA 		4	18x120	2250
	HANDTAGSBESLAG FÖR FÖNSTER - VRIDERE TIL VINDUER - VINDUESHÅNDTAG - IKKUNANPAINIKKEET 		1		
LD1	LOCK FÖR GÄNGSTÅNGSHÅL - LØKK FOR GJENGESTANGHULL - AFDÆKNING FOR GEVINDSTANGSÅBNING - KIERRETANGON AUKON KANSI 		1		
	SKARVMUTTER FÖR GÄNGSTÅNG - FORLÆNGELSESBOLT FOR GJENGESTANG - FORLÆNGELSESMØTRIK TIL GEVINDSTANG - KIERRETANGON PIDENNYSMUTTERI 		4		

Pos	16.12.2016 Delförteckning - Liste over deler - Styklister - Osaluettelo Art.Nr. 4416902	10/11	Q.	P (mm)	L (mm)
HS104	SKRUV FÖR BINDBJÄLKE TILL SKJUTVÄGG - SKRUE FOR SKYVEDØRSFESTE - SKRUE TIL SKYDEBESLAG TIL VÆG - SEINÄN LIUKUKIINNIKKEEN RUUVI 		8	3.5x20	
	SKRUV FÖR GAVELSEGMENT - SKRUE FOR GAVLEDEL - SKRUE TIL GAVLSEGMENT - KORISTEPALAN RUUVI 		4	3.5x35	
	SKRUV FÖR STOLPE - SKRUE FOR SØYLE - SKRUE TIL STOLPE - PILARIN RUUVI 		2	3.5x50	
	SKRUV FÖR GAVELLÄKT - SKRUE FOR VINDSKI - SKRUE TIL VINDSKEDE - HARJALISTAN RUUVI 		24	3.5x50	
HS1	SKRUV FÖR TÄCKLIST - SKRUE FOR DEKKBORD - SKRUE TIL DÆKLISTE - KATEPROFIILIN RUUVI 		20	3x30	
	SKRUV FÖR GOLVLÄKT - SKRUE FOR DØRLIST - SKRUE TIL DØRLISTE - OVILISTAN ASENNUSRUUVI 		5	3x30	
HS2	SKRUV FÖR TÄCKLIST - SKRUE FOR DEKKBORD - SKRUE TIL DÆKLISTE - KATEPROFIILIN RUUVI 		88	4x40	
	SKRUV FÖR TAKFOTSINKLÄDNAD - SKRUE FOR SPEILBORD - SKRUE TIL STERNBRÆDDER - RÄYSTÄSLAUDAN RUUVI 		28	4x40	
	SKRUV FÖR FÖRSTÄRKNINGSREGLAR TILL TAKFOT - SKRUE FOR FORSTERKING AV TAKFORKANT - SKRUE TIL TAGKANTSFORSTÆRKNING - KATON REUNAN VAHVISTUSRUUVI 		28	4x40	
HS103	SKRUV FÖR MONTERING AV TERRASSRÄCKE - SKRUE FOR TERRASSEREKKVERK - SKRUE TIL TERRASSEGELÆNDER - TERASSIKAITEEN KIINNITYSRUUVI 		4	4.5x80	
	SKRUV FÖR TAKBJÄLKAR - SKRUE FOR TAKBJELKER - SKRUE TIL TAGBJÆLKER - KATTOPALKIN RUUVI 		17	5x120	
	SKRUV FÖR GAVELTRIANGEL - SKRUE FOR GAVL - SKRUE TIL GAVL - PÄÄTYKOLMION RUUVI 		16	5x120	
	SKRUV FÖR 1. VÄGGREGLER - SKRUE FOR FØRSTE STOKKLAG - SKRUE TIL FØRSTE VÆGBJÆLKE - 1. SEINÄPALKIN RUUVI 		10	5x90	
	SKRUV FÖR GRUND - SKRUE FOR GRUNNMUR - SKRUE TIL FUNDAMENT - PERUSTUKSEN RUUVI 		32	5x90	
	SKRUV FÖR DÖRRKARM - SKRUE FOR DØRSTOLPE - SKRUE TIL DØRKARM - OVEN KARMIN RUUVI 		4	5x90	
HS72	SKRUV FÖR BINDBJÄLKE TILL SKJUTVÄGG - SKRUE FOR SKYVEDØRSFESTE - SKRUE TIL SKYDEBESLAG TIL VÆG - SEINÄN LIUKUKIINNIKKEEN RUUVI 		2	6x40	
	SKRUV FÖR HÖJJUSTERING AV POST - SKRUE FOR JUSTERING AV SØYLEHØYDE - SKRUE TIL HØJDEJUSTERING AF STOLPE - TOLPAN KORKEUDENSÄÄTORUUVI 		8	6x50	
	SKRUV FÖR DÖRRTRÖSKEL - SKRUE FOR TERSKEL - SKRUE TIL DØRTRIN - KYNNYKSEN RUUVI 		3	4.5x65	
	ZN SPIK FÖR GOLVLÄKT - SINKSTIFT FOR GULVLIST - ZN SØM TIL GULVLISTE - SINKITTY NAULA JALKALISTAN ASENNUKSEEN 		35	1.4x40	
	HAMMARKLOSS - HOGGESTABBE - TRÆKLODS TIL HAMRING - NAULAUSKAPPALE 		1		
	SLAGMUTTER FÖR GÄNGSTÅNG - DRIVMUTTER FOR GJENGESTANG - DRIVMØTRIK TIL GEVINDSTANG - KIERRETANGON OHJAUSMUTTERI 		4		
	MUTTER FÖR GÄNGSTÅNG - MUTTER FOR GJENGESTANG - MØTRIK TIL GEVINDSTANG - KIERRETANGON MUTTERI 		4		
	FÖRZINKAD SPIK TILL TERRASS - SINKSPIKER FOR TERRASSE - ZN SØM TIL TERRASSE - SINKITTY TERASSINAULA 		168	2.1x50	
	FÖRZINKAD TAKSPIK - SINKSPIKER FOR TAK - ZN SØM TIL TAG - SINKITTY KATTONAULA 		404	2x50	
	FÖRZINKAD GOLVSPIK - SINKSPIKER FOR GULV - ZN SØM TIL LOFT - SINKITTY LATTIANAULA		350	2x50	

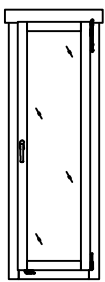
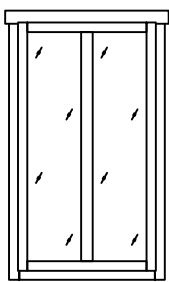
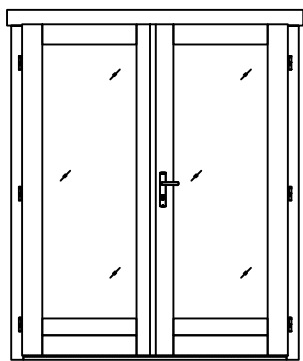
Pos	16.12.2016 Delförteckning - Liste over deler - Styklister - Osaluettelo Art.Nr. 4416902	11/11	Q.	P (mm)	L (mm)
	FÖRZINKAD SPIK FÖR TAKLÄKT - SINKSPIKER FOR TAKPAPPLIST - ZN SØM TIL TAGPAPPLISTE - KATTOHUOPALISTAN SINKITTY NAULA		24	2x40	
GS	GAVELSEGMENT - GAVLEDEL - GAVLSEGMENT - KORISTEPALA		2		
	PLANBRICKA FÖR GÄNGSTÅNG - STOPPSKIVE FOR GJENGESTANG - SKIVE TIL GEVINDSTANG - KIERRETANGON ALUSLAATTA		4	D10	
SB	PLANBRICKA - STOPPSKIVE FOR SKYVEDØRSFESTE - SKIVE TIL SKYDEBESLAG TIL VÆG - ALUSLAATTA		2	D6	
SL	BINDBJÄLKE TILL SKJUTVÄGG - SKYVEDØRSFESTE - SKYDEBESLAG TIL VÆG - LIUKUKIINNIKE SEINÄÄN		2		
	HANDTAG FÖR DÖRR - DÖRBESLAG - DØRHÅNDTAG - OVENPAINIKE		1		
	SATS MED TÄCKBRICKOR FÖR DÖRRLÅS - ET SETT AV DÖRBESLAG - SÆT AF LÅSEDÆKSLER - LUKKOKILPISARJA		1		
	CYLINDER - SYLINDERLÅS - CYLINDERLÅS - SYLINTERILUKKO		1	30x35	
	GÅNGJÄRN FÖR DÖRR - BOLT FOR DØRHENGSEL - HANSKRUE TIL DØRHÆNGSEL - OVEN SARANA		6	14x80	
HC	GÅNGJÄRNSKÅPOR FÖR DÖRR - DEKSEL OVER HENGSEL - HÆNGSEL-DÆKSEL - OVEN SARANASUOJA		12		
	LÅSETS SLUTSTYCKE - FALLELÅSENS SLUTTSTYCKE - LÅSENS SLUTSTYCKE - OVENSALVAN VASTAKAPPALE		2		
RFP	HÖJDJUSTERING AV POST - JUSTERING AV SØYLEHØYDE - HØJDEJUSTERING AF STOLPE - TOLPAN KORKEUDEN SÄÄTÖ		1	D16	
	FÖNSTER - VINDU - VINDUE - IKKUNA 560x1780		AK.1.100.PSP DGP+	1	
	FÖNSTER - VINDU - VINDUE - IKKUNA 1010x1780		TAK.1.100.PM0.e DGP+	1	
	DÖRR - DØR - DØR - OVI 1588x1957		TUK.1.100.PVP.MM DGP+	1	