

ASSEMBLY PLAN - DISPLAY YORKIE 44 - UID - 12149



BEFORE STARTING

Before starting the assembly, you should make sure that you have:



Someone to help you



A spirit level



A ladder



A screwdriver



A saw



A hammer



A boxcutter



A tape measure



A pair of pliers

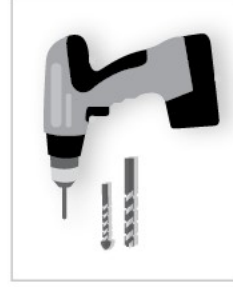

A drill

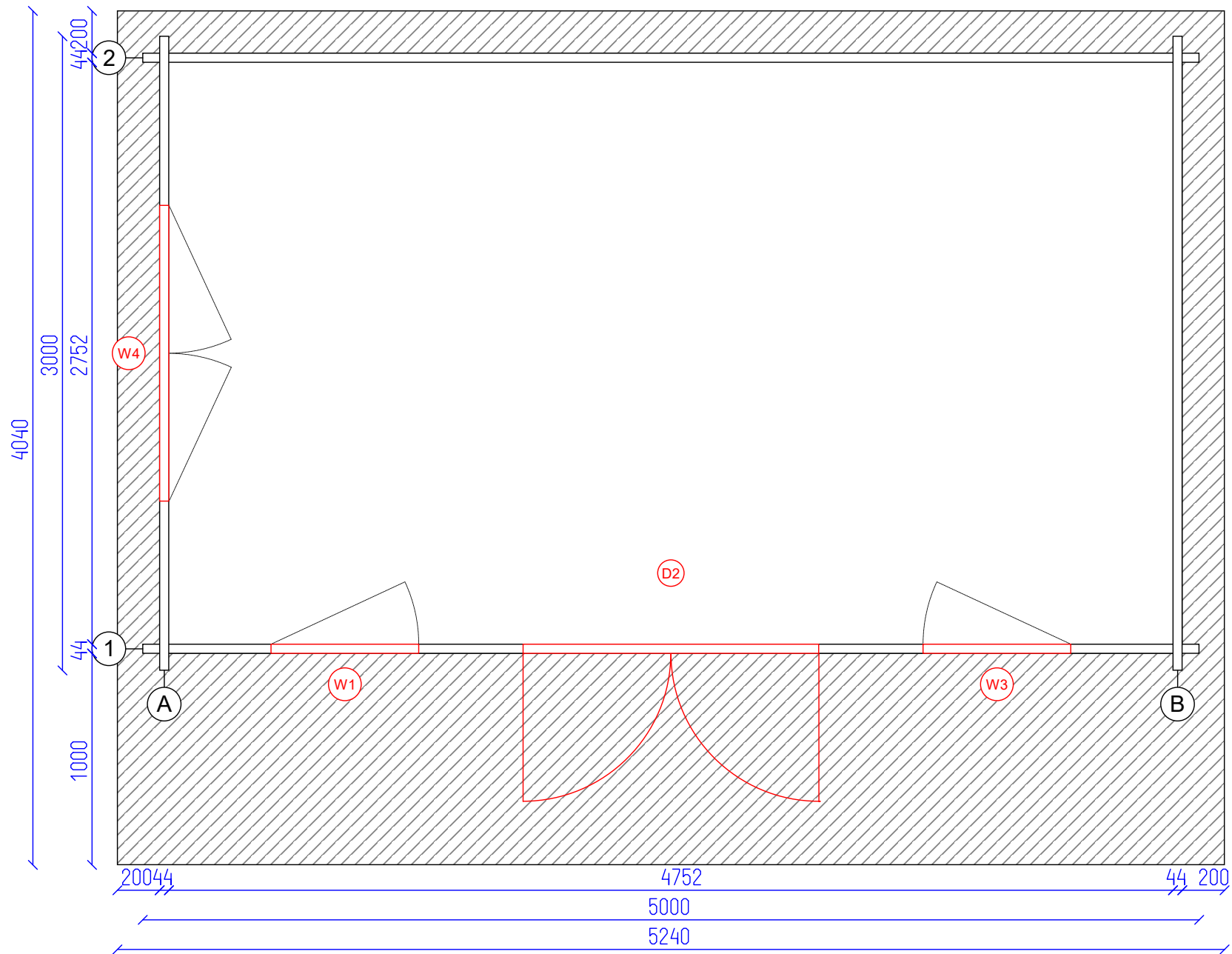

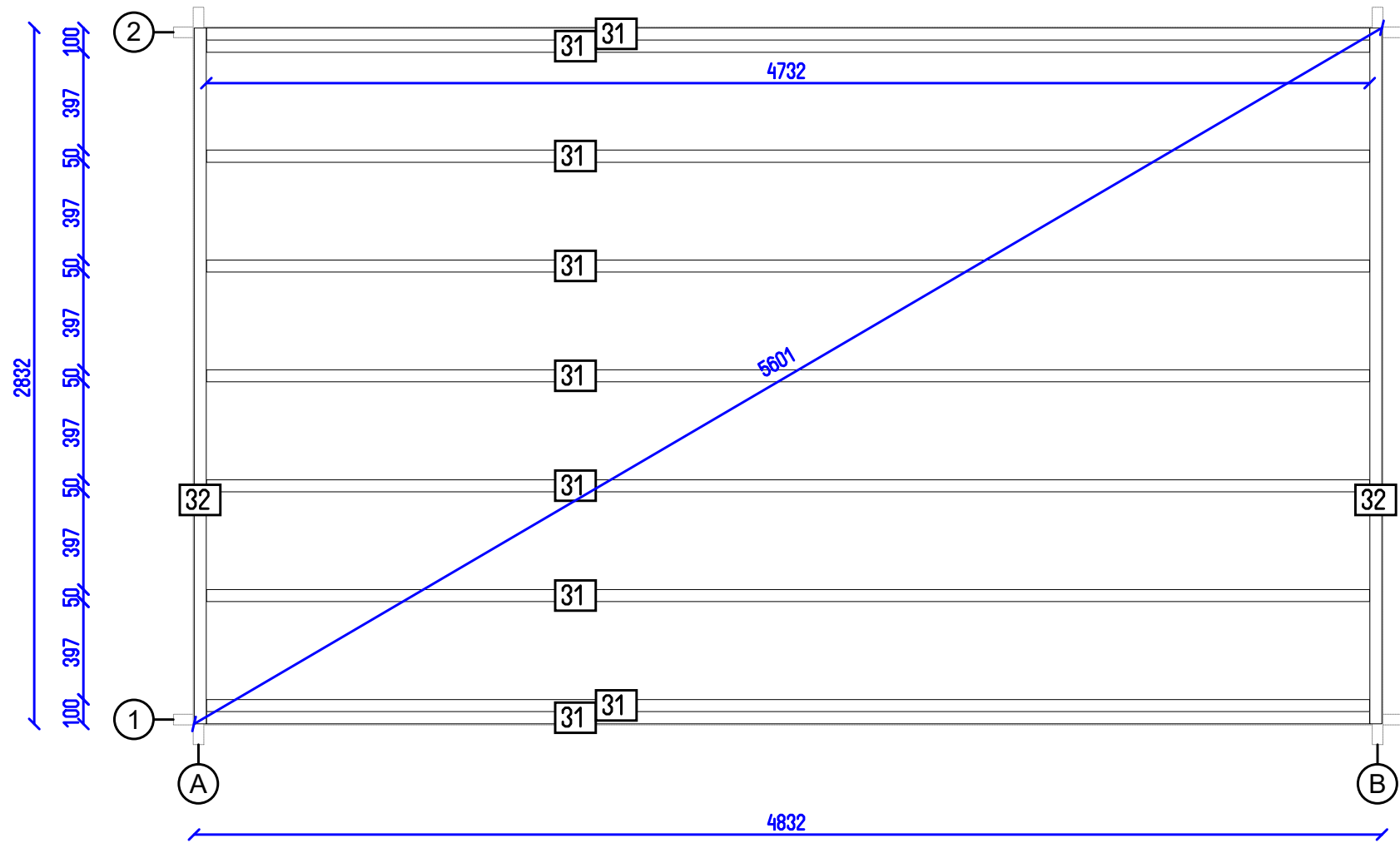

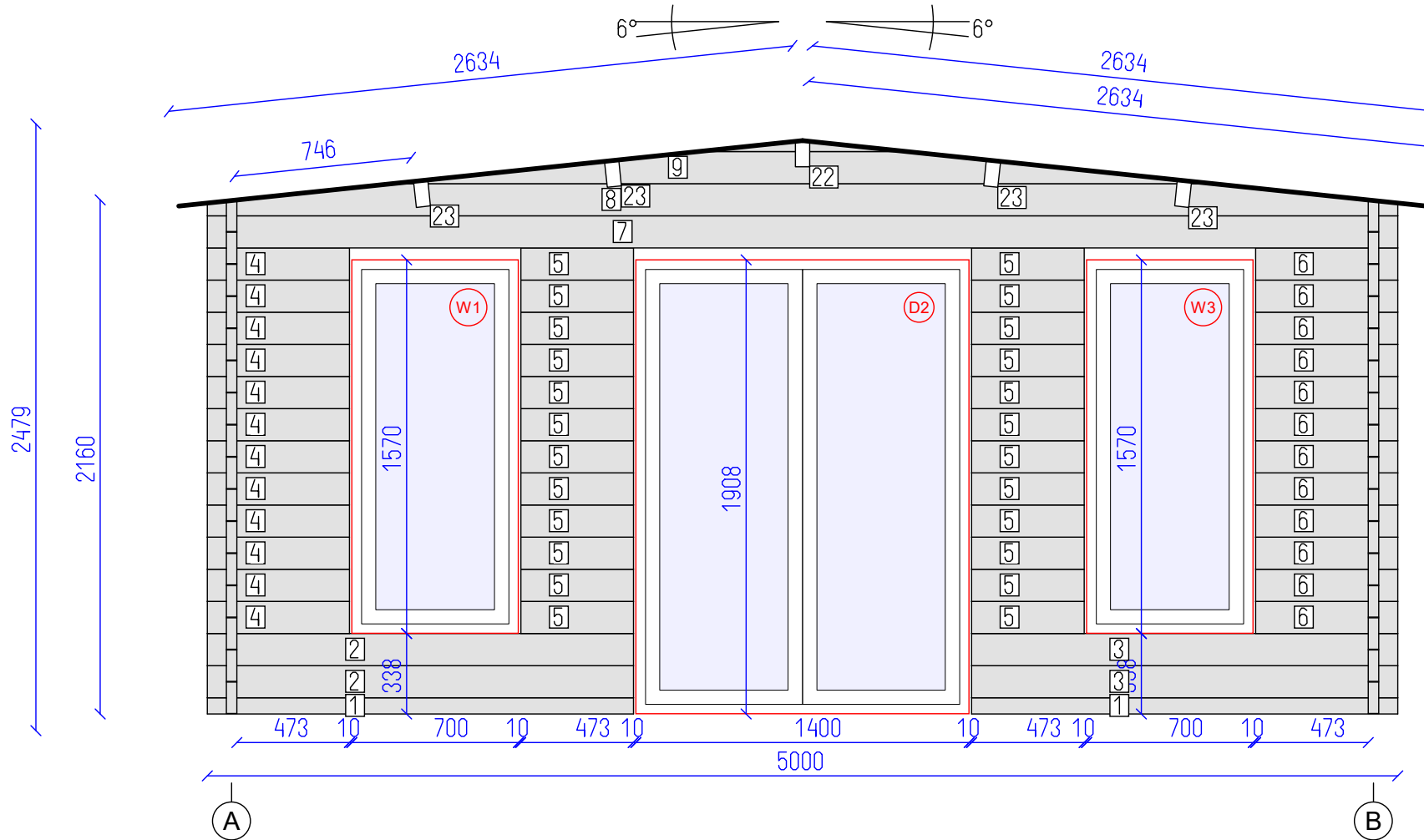

DETAILS

N	QTY
1	2
2	2
3	2
4	12
5	24
6	12
7	1
8	1
9	1
22	1
23	4

LIST OF ELEMENTS

1. Wall 68x44x1790
 2. Wall 135x44x1790
 3. Wall 135x44x1790
 4. Wall 135x44x597
 5. Wall 135x44x473
 6. Wall 135x44x597
 7. Wall 135x44x5000
 8. Wall 135x44x5000
 9. Wall 135x44x3450
 22. Roof beam 140x70x4040
 23. Roof beam 140x70x4040
- Total 9.32 m²

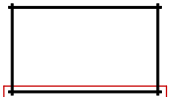

Display Yorkie 44

Wall 1

Tikr.
AND

Dare
AND

4
SHEET

33
OF

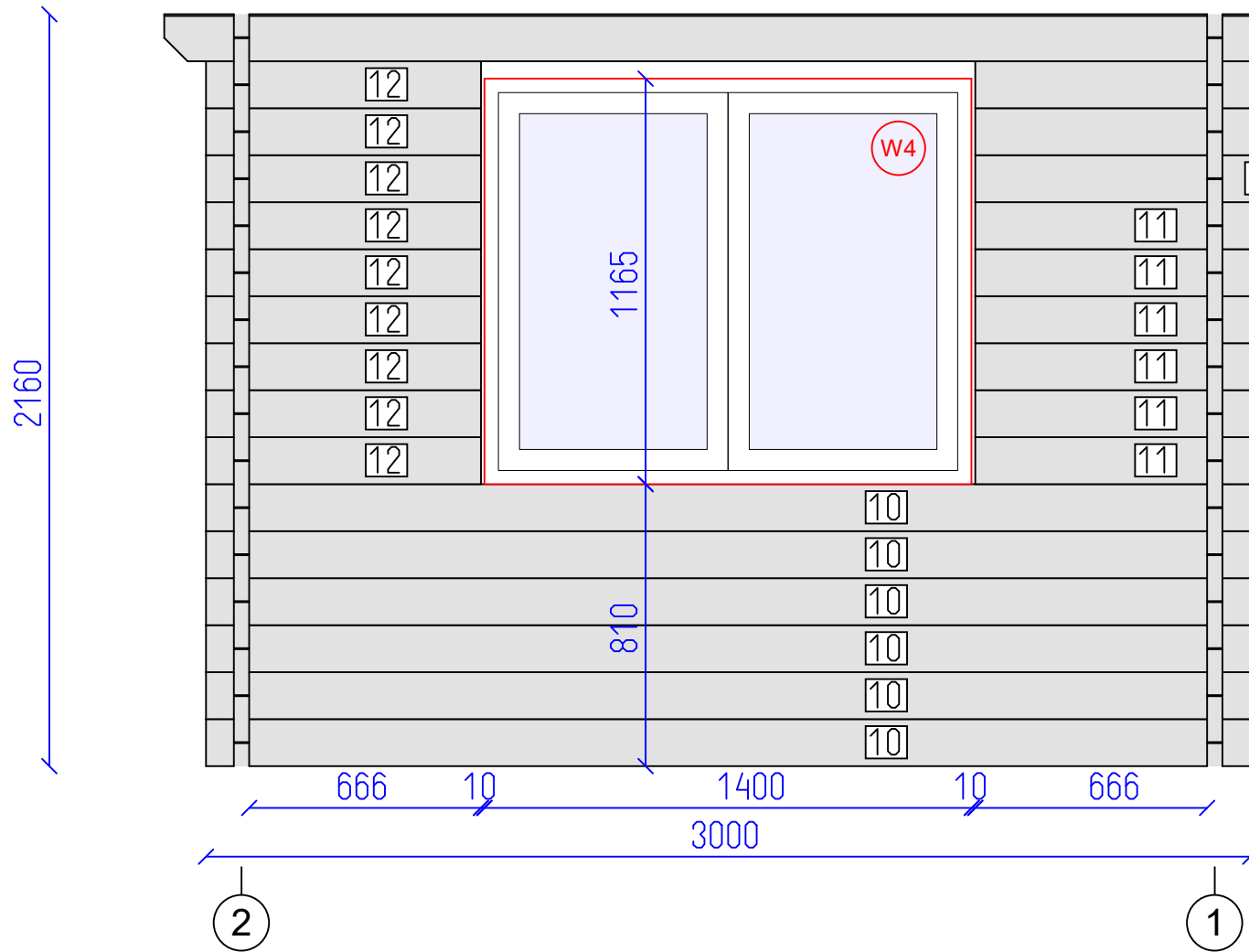

DETAILS

N	QTY
10	6
11	6
12	9
13	1
14	1
15	1
16	1

LIST OF ELEMENTS

- 10. Wall 135x44x3000
 - 11. Wall 135x44x790
 - 12. Wall 135x44x790
 - 13. Wall 135x44x960
 - 14. Wall 135x44x1210
 - 15. Wall 135x44x1460
 - 16. Wall 135x44x4040
- Total 5.07 m²

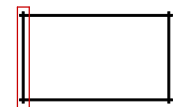

Display Yorkie 44

Wall A

Tikr.
AND

Dare
AND

5
SHEET

33
OF

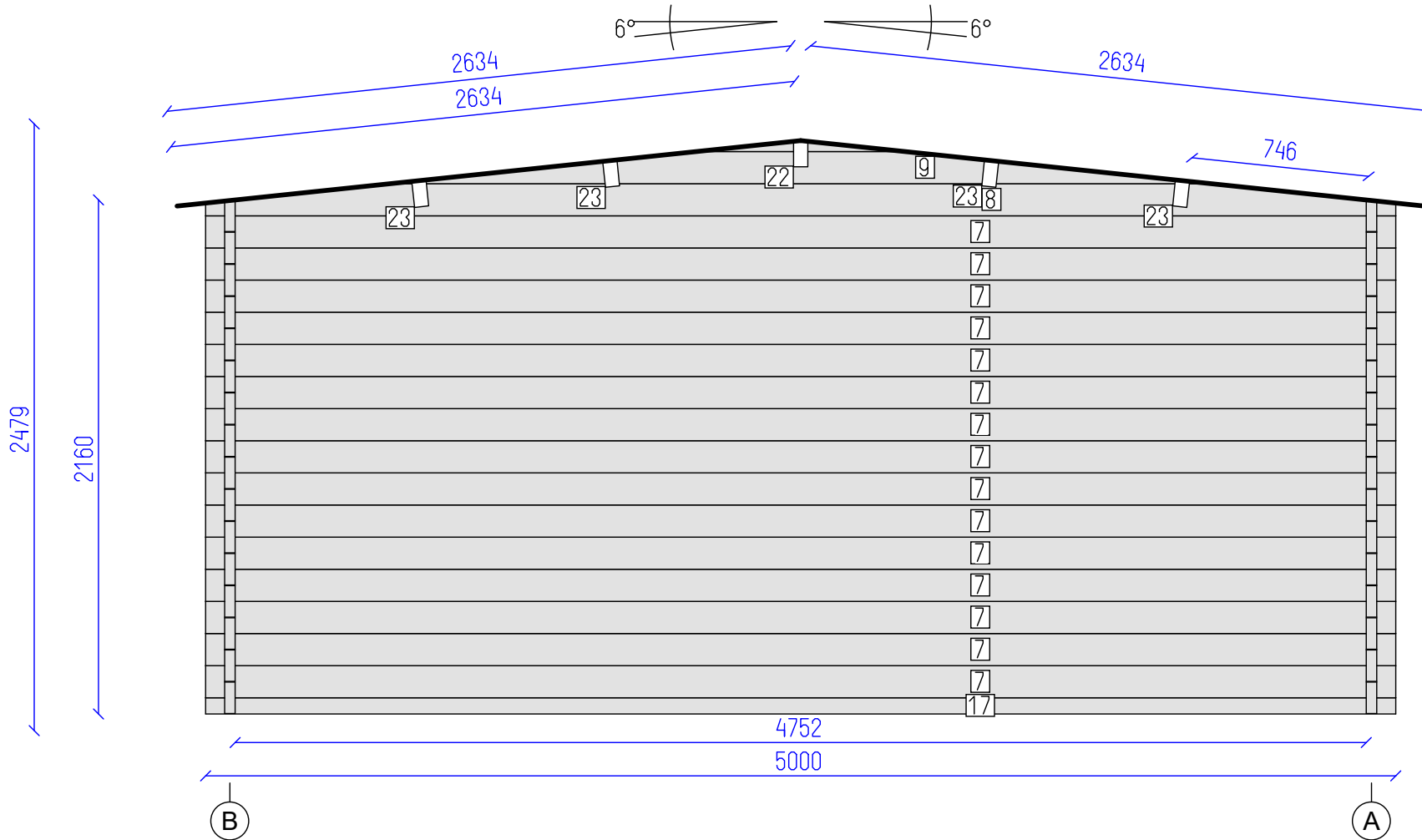

DETAILS

N	QTY
17	1
7	15
8	1
9	1
22	1
23	4

LIST OF ELEMENTS

- 17. Wall 68x44x5000
- 7. Wall 135x44x5000
- 8. Wall 135x44x5000
- 9. Wall 135x44x3450
- 22. Roof beam 140x70x4040
- 23. Roof beam 140x70x4040
- Total 14.43 m²



Display Yorkie 44

Wall 2

Tikr.
AND

Dare
AND

6
SHEET

33
OF

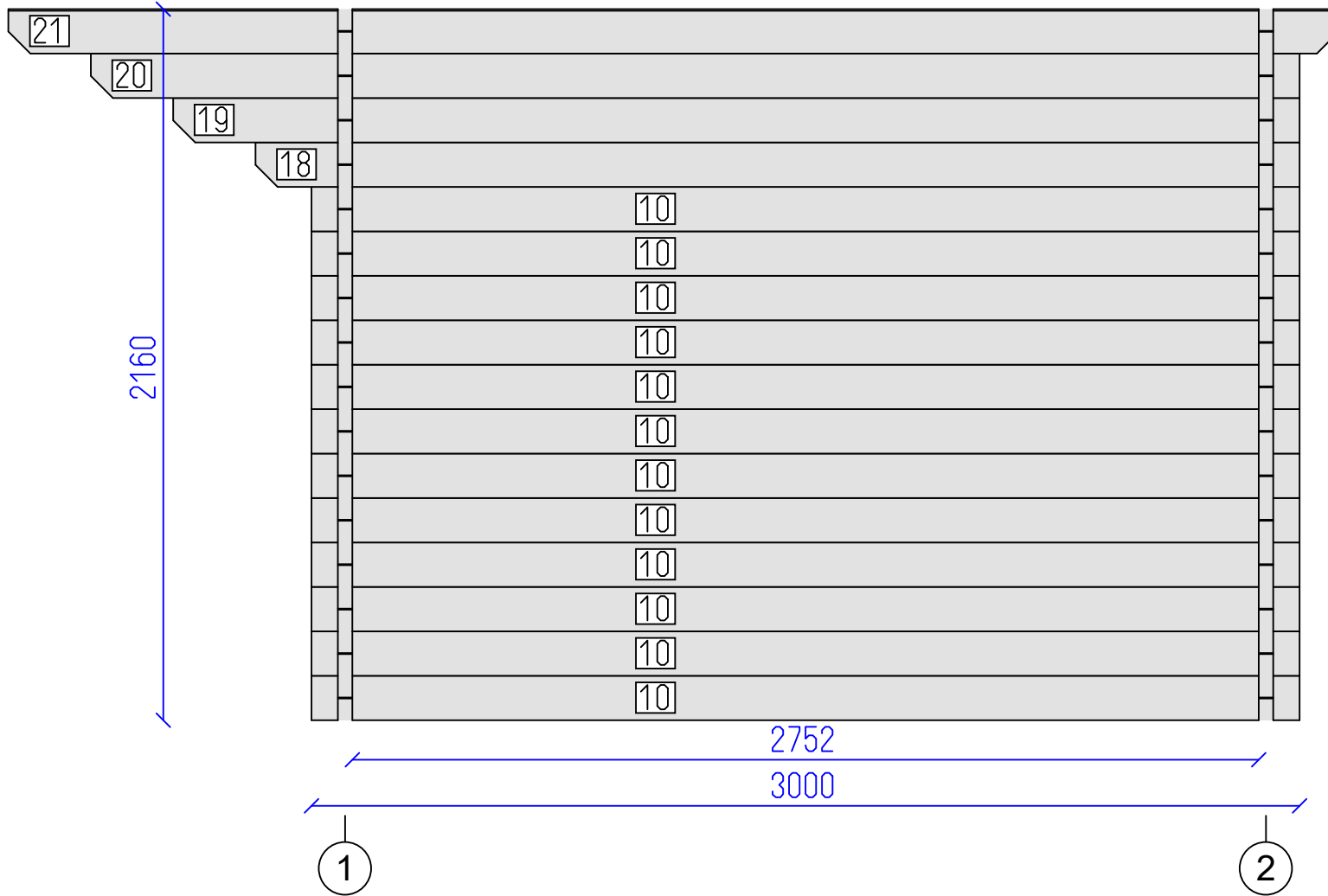

DETAILS







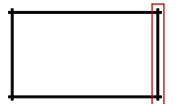





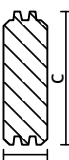

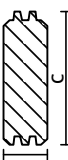

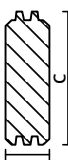

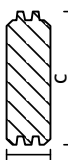

















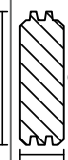









N	QTY
10	12
18	1
19	1
20	1
21	1

LIST OF ELEMENTS











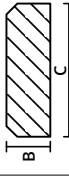

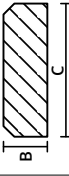

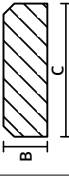

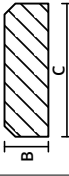



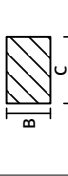









- 10. Wall 135x44x3000
 - 18. Wall 135x44x3170
 - 19. Wall 135x44x3420
 - 20. Wall 135x44x3670
 - 21. Wall 135x44x4040
- Total 6.79 m²









Display Yorkie 44

	Dimensions, mm	Pos.	Quantity				
				A	B	C	
Wall			1790	44	68	1	2
Wall			1790	44	135	2	2
Wall			1790	44	135	3	2
Wall			597	44	135	4	12
Wall			473	44	135	5	24
Wall			597	44	135	6	12
Wall			5000	44	135	7	16
Wall			5000	44	135	8	2
Wall			3450	44	135	9	2
Wall			3000	44	135	10	18
Wall			790	44	135	11	6
Wall			790	44	135	12	9
Wall			960	44	135	13	1
Wall			1210	44	135	14	1
Wall			1460	44	135	15	1
Wall			4040	44	135	16	1
Wall			5000	44	68	17	1
Wall			3170	44	135	18	1
Wall			3420	44	135	19	1
Wall			3670	44	135	20	1
Wall			4040	44	135	21	1
Roof beam			4040	70	140	22	1
Roof beam			4040	70	140	23	4

Display Yorkie 44

			Dimensions, mm			Pos.	Quantity
			A	B	C		
Front fascia			2834	17	115	24	4
Top fascia			2674	17	115	25	4
Side fascia			4040	17	115	26	2
Fascia beam			2000	41	31	27	2
Fascia beam			1540	41	31	28	2
Fascia beam			500	41	31	29	2
Roof board			2634	19	135	30	62
Floor beam			4732	50	70	31	9
Floor beam			2832	50	70	32	2
Floorboard			2742	19	110	33	44
Baseboard			2000	19	40	34	4
Baseboard			2000	19	40	35	2
Baseboard			752	19	40	36	4
Extra Wall Log			5000	44	135	37	1

Nr.	vnt.	Mounting parts
	1 komp.	AS-01 + AS-02 + AS-03 + AS-04 / Sukimo antgaliai / Drill Bits / T15, T20, T25, T30 
	83 vnt.	MS-04 / Medsraigčiai / Woodscrews / 5x120 / bearers connection 
	14 vnt.	MS-05 / Medsraigčiai / Woodscrews / 6x180 / Bottom logs and bearers connection 
	499 vnt.	MS-06 / Medsraigčiai / Woodscrews / 4x45 / fastening of floor boards, window/door architraves, fascia battens, fascia boards, OSB 
	206 vnt.	VN-01 / Vinys / Nails / 3,0x70 / Roof boards, battens, purlins fastening 
	110 vnt.	VN-04 / Vinys / Nails / 1,8x50 / Skirting and revestment boards fastening 
	8 komp.	VM-06 + VR-02 / Varžtai ir ikalamos verzles / Bolts and tee nuts / M8x28, M8 / Door and window position fixation 

DEAR CLIENT,

Thank you for choosing one of our environment-friendly wooden houses!

Your wooden house is an eco-product manufactured from 100% renewable natural resources. It is made with the highest-quality wood, grown in Nordic conditions. Our caring attitude towards the sustainable use of natural resources is reflected in the FSC certificate issued to our company.

We use advanced technology in the production of our products and we implement our extensive experience in the field of wooden house production. We can assure you that, before your wooden house was delivered to you, it had undergone (and passed) a thorough inspection procedure.

Wood is a 100% natural material which can expand and shrink (by less than 3% of its width or thickness).

There can also be slight differences in its colour, and some elements may be slightly twisted or bent, but these peculiarities will not hamper the installation of your wooden house.

Besides ecological cleanness, wood is widely considered to be the most appealing construction material. Every wooden element in a wooden house is unique and special, due to its texture and the size and shape of its branches. The stability of the product is not impaired by intact or ingrown knots, resin pockets, small fissures or cracks caused by the drying process of each element, if they have not penetrated through it. There may be finger-jointed elements in your wooden house which, during processing, have become even more stable to withstand twisting and bending that could occur in the future. When using your wooden house, you should take the normal physical phenomena (e.g., condensation forming on windows) into consideration.

IMPORTANT INFORMATION:

- These are general installation instructions that apply to different types of wooden houses. Before starting to install your house, verify that the set is complete and that all the elements are of high quality. The list of elements can be found on the illustrations of the house. If you happen to find a damaged or missing element, the problem should be immediately recorded by taking photos (before you start assembling) and reported to the Seller. Please, also acquaint yourself with the terms and conditions of the warranty that applies to your wooden house.
- Before you start installing your wooden house, read these instructions carefully. They will help you prevent potential problems.
- Do not leave the package containing the elements of the wooden house or the elements themselves exposed to weather conditions, in contact with the ground or in heated rooms.
- Ensure that there is no transport damage. If you detect any damage to the packaging or elements, immediately record it by taking photos and send them (along with a description) to the Seller.
- Prepare foundations that match the size of the house and the peculiarities of the soil into account. Only strong, perfectly levelled foundations will ensure a smooth installation process.
- During the installation, pay attention to any weather conditions (wind, snow, ice or rain) that could damage the product.
- The minimum distance between the upper edge of the foundation and the first wall element of the wooden house should be 45 mm.
- A damp-proof barrier should be used between the foundation and the wooden structure.
- The sub-frame should be level and square.
- The outer edge of the bottom wall row should be installed 5 mm beyond the outer edge of the foundation.
- To ensure the safety and long life of the wooden house, it is important to protect it from weather conditions with the help of anchors, storm strips and roofing felt strips — even if these accessories are not included in your set.
- Do not rigidly fix any objects to the walls which could hamper the normal drying, shrinking, settling and expansion of the wooden house. (This should also be borne in mind when fastening the nut of the storm strip.)
- Roofing felt as a covering material (if included in the set) is designed for short-term use only. However, it is also suitable for use as an underlayer with other roofing materials.
- When installing roof boards, the need for a 1-2 mm expansion gap should be borne in mind.
- After installation, in order to prevent discolouration, bending and expansion, the garden house must be finished in its entirety with a wood preservative, at least on the outside (including windows and doors, which must be treated on both sides) not later than 14 days after the assembly. Regarding the choice of wood preservative, we recommend consulting an expert/paint specialist or the Seller of the garden house.
- It is necessary to install rainwater systems and provide for the discharge of excess water to ensure improved resistance to weather conditions and longer life for your wooden house. For instance, you should mount rain gutters and subsills (not included in delivery). Otherwise, water may penetrate through crevices at windows, doors and corners of the house. For detailed advice, please contact the distributor or a construction specialist.

RECOMMENDATIONS:

- To prevent splits in the wood, we recommend pre-drilling screw holes.
- There may be unplanned areas, dull areas or areas where knots extend beyond the edge of the roof or floor boards of the wooden house. To achieve the best results, the boards can be placed so that these defects remain hidden by rotating the boards as necessary.
- To achieve better weather resistance, the points of contact between the glass and the wood should be sealed with silicon, once the doors and windows have been painted.

Please inform the Seller of the wooden house of your experience regarding this product, be it positive or negative. Such feedback helps us improve the quality of our products and the service so as to be able to meet your needs and expectations.

ASSEMBLING THE JOISTS

The foundation is a structure that supports the whole building. Its uneven settling may cause loss of stability and affect the entire building. The type of foundation should be based on the geographical peculiarities of the location (e.g., the soil and the freezing depth of the ground) in which the wooden house will be built and on the nature of the particular building. We recommend the following types of foundations: block foundation, strip footing, pier foundation, or base slab. It is important to ensure that, when building the wooden house, the sub-frame is level and square. Squareness can be checked by comparing the lengths of the diagonals. Depending on the type of the house, the cross-sections and installation methods of a sub-frame may be different - check this in the installation instructions of the wooden house. In order to prevent complaints later on, please consult an expert.

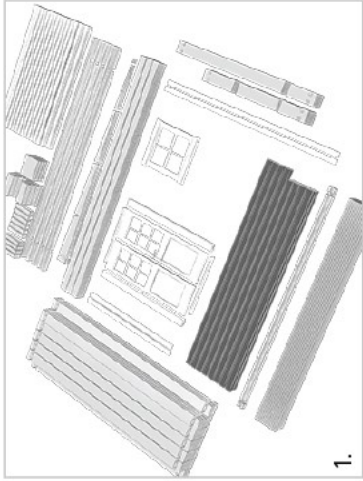

1.

First of all, unpack all the items and group them by form and size.

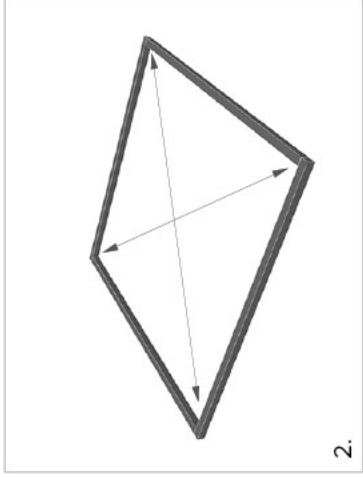

2.

Place the outside joists on the foundations. Check the level, angles and diagonals. Then, anchor them in the foundations.

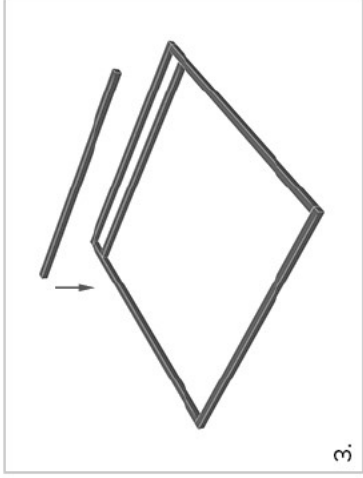

3.

Place the inner joists in regular intervals as specific to your cabin plan.

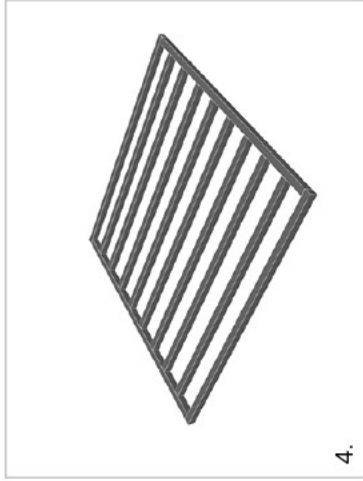

4.

Screw the inner joists to the outside joists.

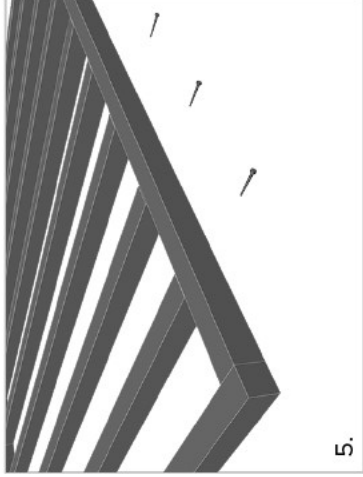

5.

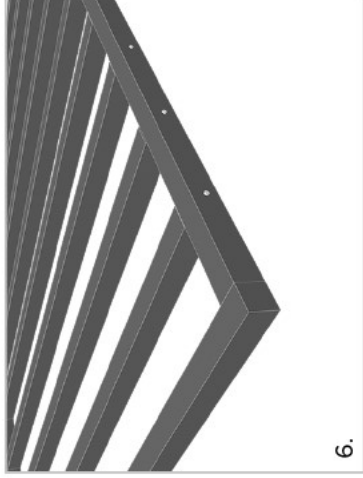

6.

ASSEMBLING THE FIRST BEAMS



IMPORTANT! If your cabin is without floor and joists, after laying the first beams, check the level, angles and diagonals; and then anchor the first beams to the foundations!

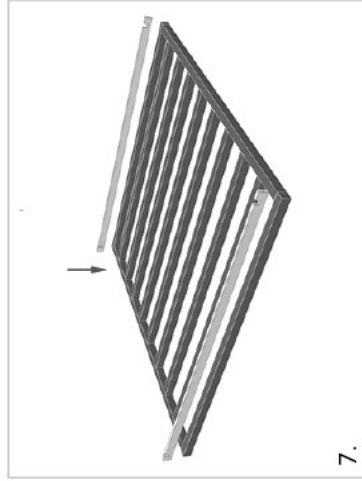

7.



8.

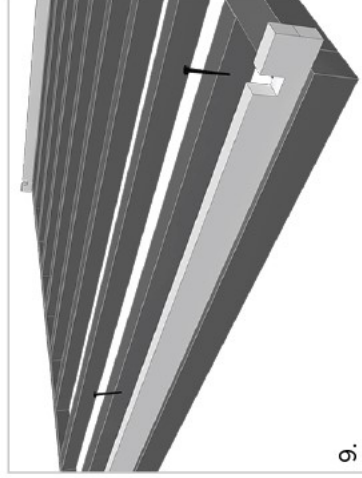

9.

Place the half-beams first, as shown in the picture, and once they are at the right place, screw them to the joist.



10.

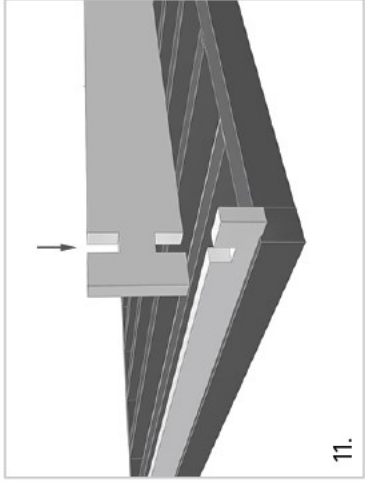

11.

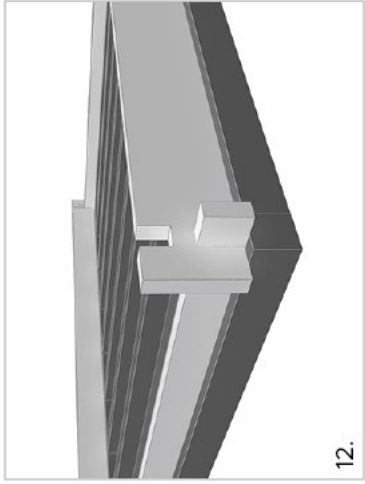

12.

Then, the full beams can be placed on both remaining sides.

ASSEMBLING WALLS

Do not over-tighten the bottom nut of the threaded bar - otherwise, you may damage the upper part of the gable element.

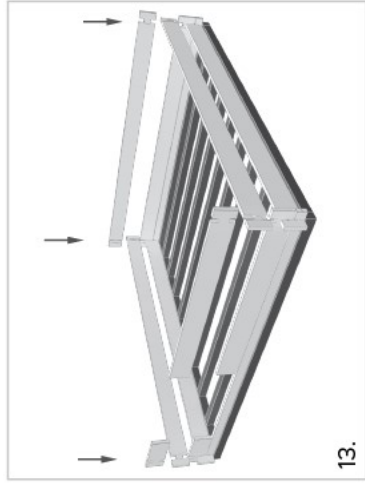

13.

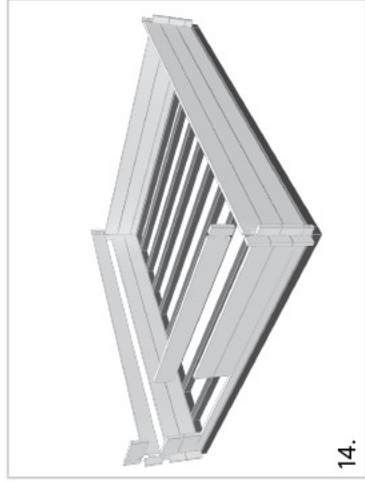

14.

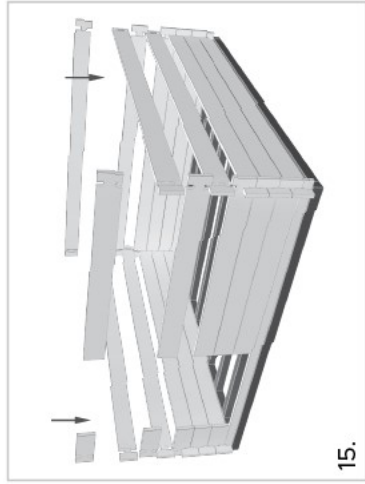

15.

Place the beams one by one in their numerical order as per the technical plan of your particular cabin.



16.

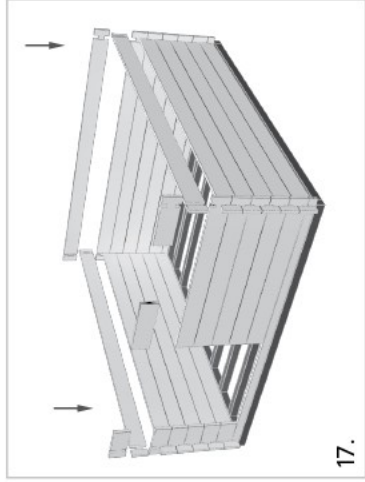

17.

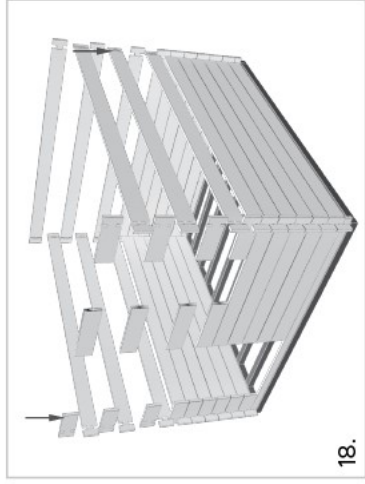

18.

! IMPORTANT! Regularly check the level of the walls.



**FOR HOUSES THAT ARE
LONGER THAN 6 M LENGTH**

In the case of wall beams longer than 6 meters, they must be connected together with a metal plate (included in the package). Put the two beams together and fix the metal plate with four screws.

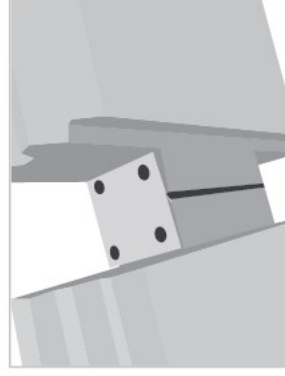



19.

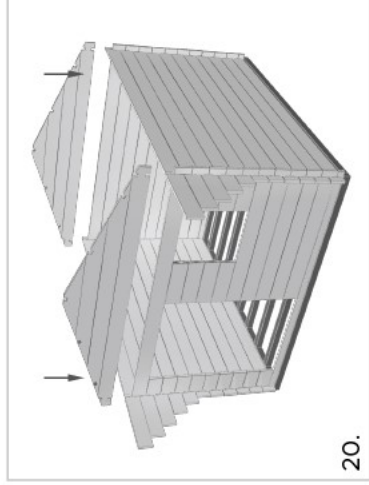

20.

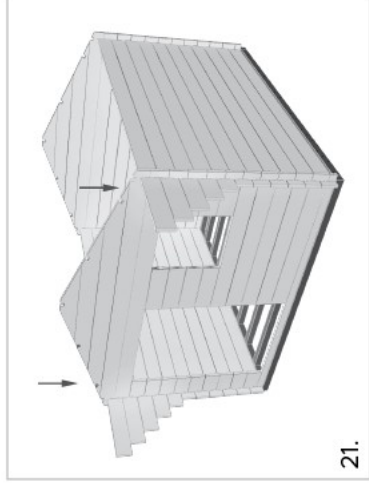

21.

In most cases the gables are already made. Once the last wall beams are in place, fit the gables as per instructions on the front and rear face and fix them with screws.



IMPORTANT! If the sides of the gable are not level with the upper wall beams, you should tap the upper wall beams gently with a hammer to lower them and/or shave the gable until it is at the right level.



Support boards may be needed to stabilize the vertical edges of the openings where doors and windows are going to be fixed. If that is the case with your house, fix them by putting them in the recesses of the edges. Don't screw them to each of the wall logs, because this will prevent the settling of the house.

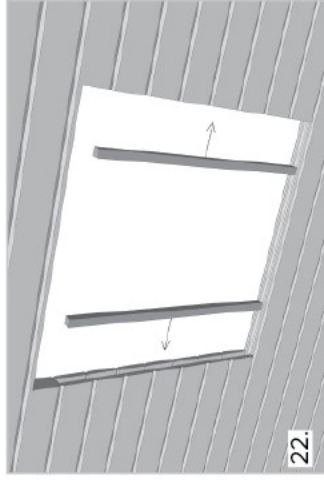

22.

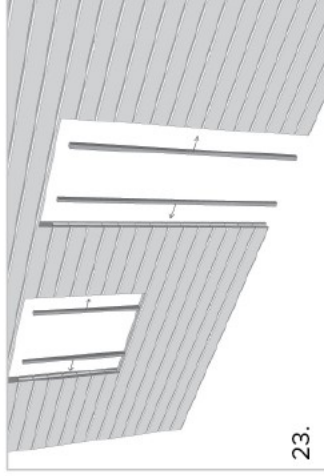

23.



24.



25.

Place the storm braces inside the cabin in all corners.



Depending on the model, the gable may also be made of several pieces!

ASSEMBLY OF THE POSTS

Your house may include posts. Assemble them in accordance with the drawings provided. If an adjustable post base is included and you decide to use it, shorten the post by cutting the bottom in accordance with the specifics of your house. Then, fix the base underneath the post during the assembly of the house. The adjustable post base should be adjusted periodically as the house will be setting down gradually.

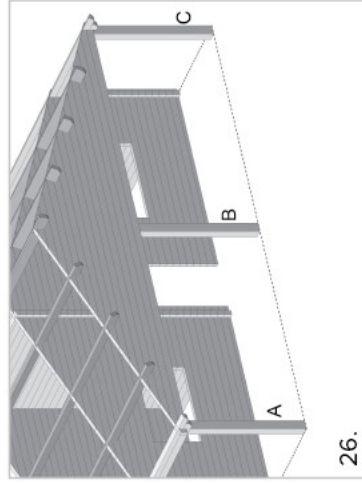

26.

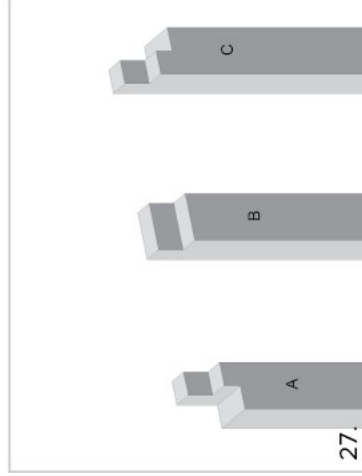

27.

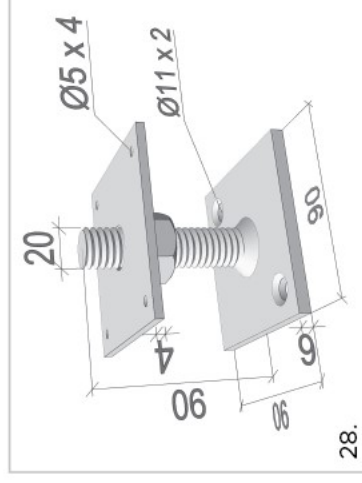

28.

ASSEMBLY OF DOUBLE WALLS

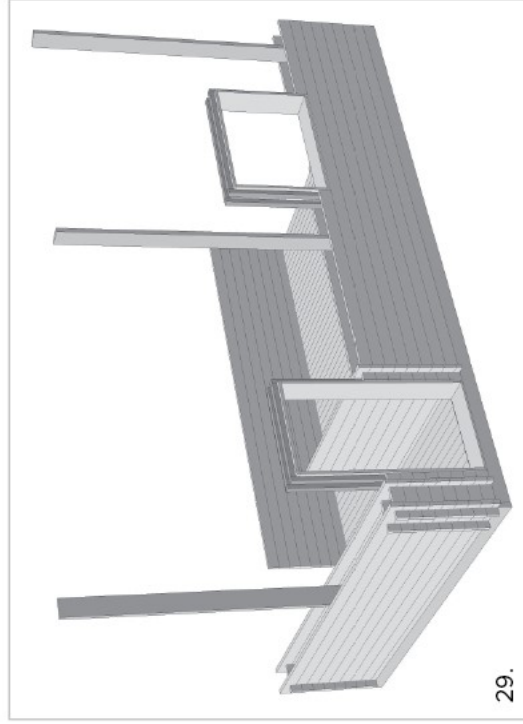

29.

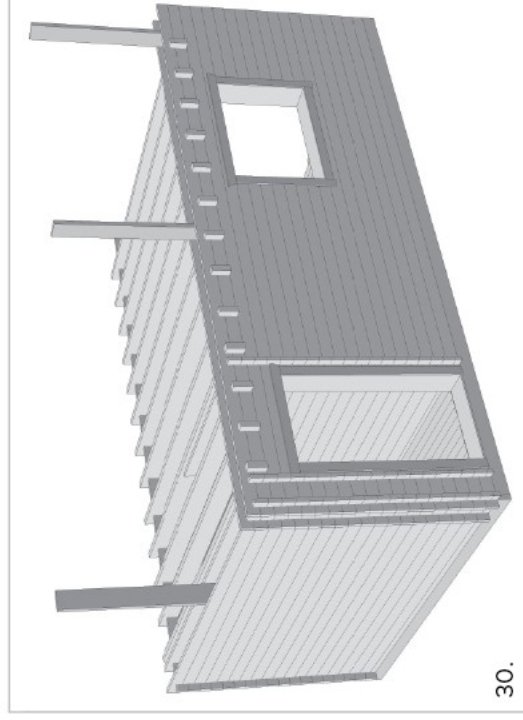

30.

A long board might be included to be attached between the double walls for stability. If that is the case with your house, make sure to place the board in the middle between the two walls in a vertical position, according to the drawings provided. These boards might not be cut to the correct length. Make sure to cut them, leaving around 80 mm on the top to allow room for the house to settle down over time. An alternative way to place this beam is to cut it to the right length, leaving 80 mm underneath it and securing its upper end to the upper logs of the wall. This way, it will settle together with the house and there will be enough space underneath for it to sit down.



For assembly of door and windows in double walls, check the paragraph below.

ASSEMBLY OF THE ROOF

When assembling the roof boards, use a stable ladder. Start installing from the side of the front wall. Use nails and fasten the roof boards to all rafters, side walls and gables. During the assembly, pay attention to the diagonals of the roof surface. Natural bending in the rafters can be eliminated during the assembly of the roof boards. The boards should end on the rafter ends on both the front and rear walls. If needed, cut the last roof board to a suitable width.

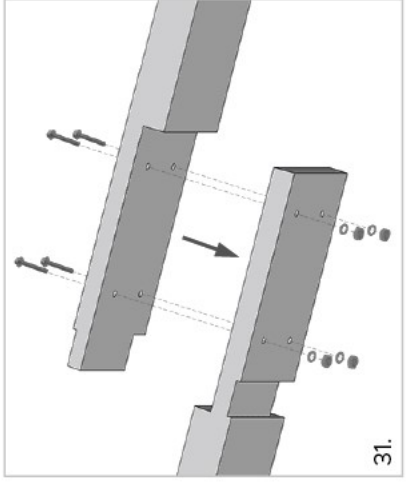

31.

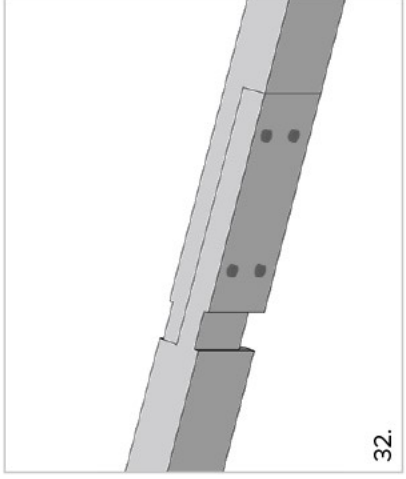

32.

For rafters that are longer than 6 metres, there is a special connection. Connect as shown in the picture, with 4 bolts (included in the package), before placing on the ridge triangle.

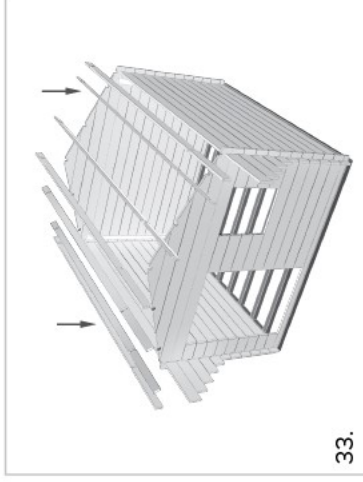

33.



34.

Place the rafters in the precut spaces, as shown in the technical plan.



IMPORTANT! If the sides of the triangles are not level with the wall beam, gently tap the wall beams with a hammer to lower them and/or shave the triangles until they come to the right level.

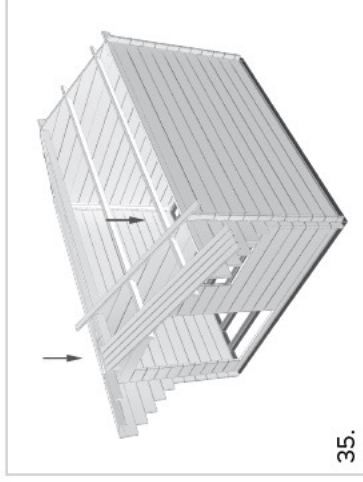

35.



36.

Start laying roof boards from the extremity of the house. Nail them carefully. Do not hit the nails or boards too hard.



37.



38.

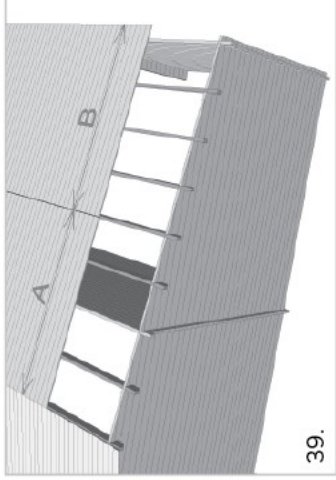

39.



Roof boards may be divided into two parts. Make sure they will meet directly in the middle of a rafter when you assemble them.

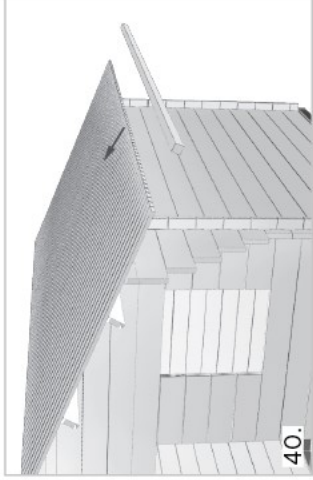

40.

Mount/screw the fascia support board under the extremity of the roof boards on the sides.

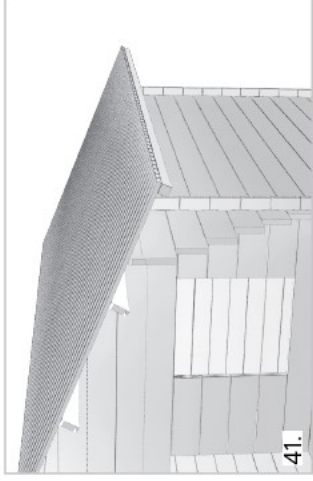

41.

When installing covering strips and roofing felt, use a stable ladder. First, fasten the eave reinforcement and eave. Next, install the roofing felt (if included in the assembly set). Cut the felt to the length shown in the felt producer's instructions and pay attention to the same instructions when placing the first piece, so that it overlaps with the eave. Depending on the type of wooden house, the eave and the eave reinforcement may vary.



42.

Screw the front and back fascia boards.



43.

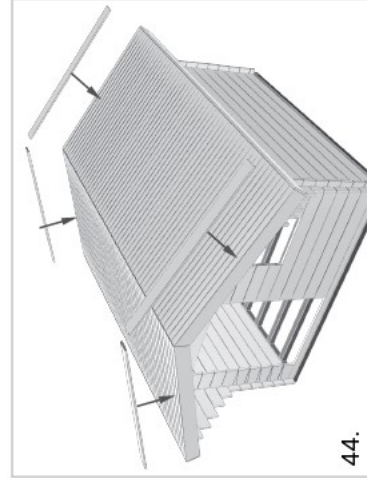

44.

Screw the top fascia boards.



45.



IMPORTANT! Mount the top fascia boards only after you lay the roofing (shingles or other).

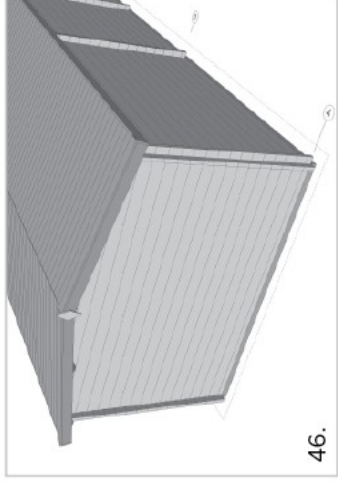

46.

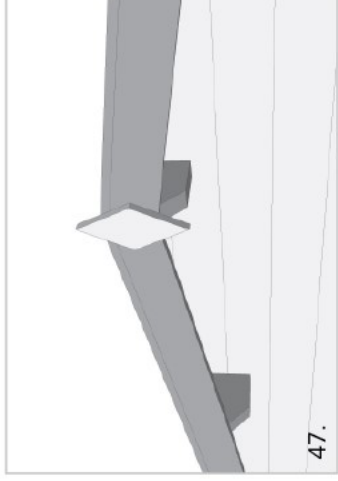

47.

If your house has a rhombic ornament on the ridge, fix it in the centre of the ridge, where the two front fascia boards meet. Make sure it stays straight.

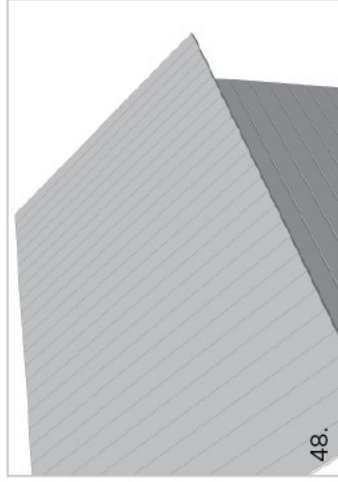

48.

If your house has a dormer (a clock house), first finish assembling the roof boards on the side where the dormer is going to be assembled.

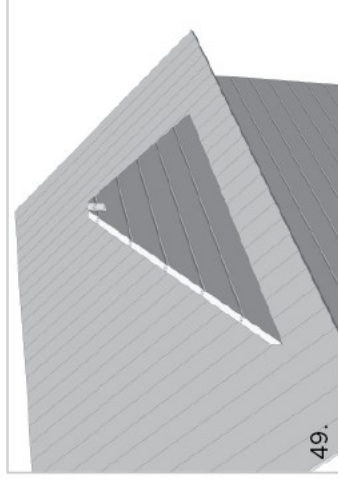

49.

Assemble the gable of the dormer on top of the roof boards, directly over the wall of the house.

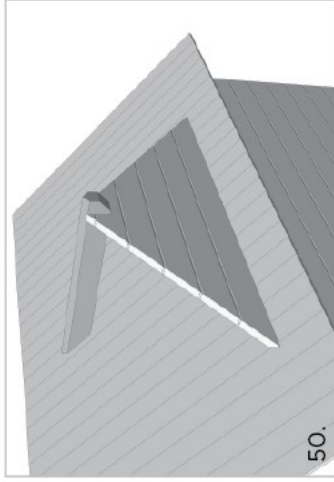

50.

Assemble the rafter by fixing one side on the gable and resting the other side on the roof boards.

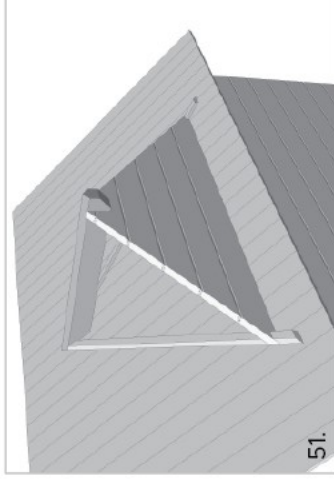

51.

Fix the diagonal support boards on both sides, as shown in the picture.

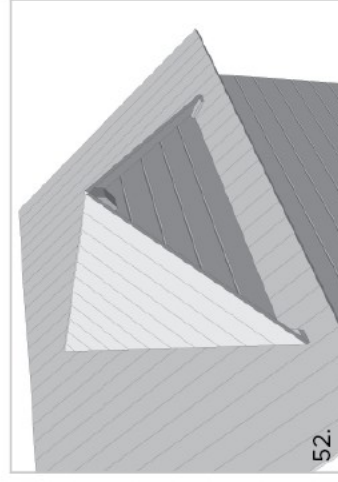

52.

Lay the roof boards and nail them carefully. Do not hit the nails or boards too hard.

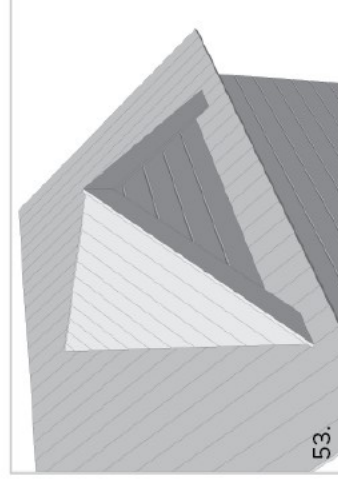

53.

Finish off by screwing the fascia boards.

ASSEMBLY OF INSULATED ROOF

If the roof of your house has insulation, first assemble the roof boards, then fix the insulation beams on top of them. Continue adding the insulation material and the membrane (diffusion film). Then, fix the battens (ventilation beams) on top of the membrane, directly over the insulation beams.

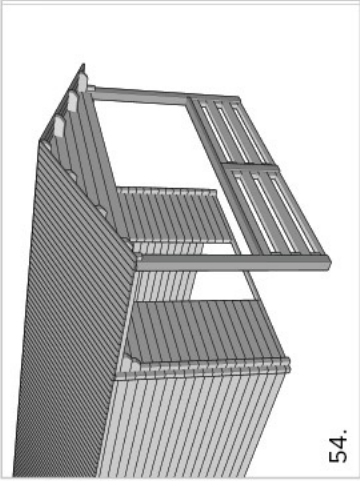

54.

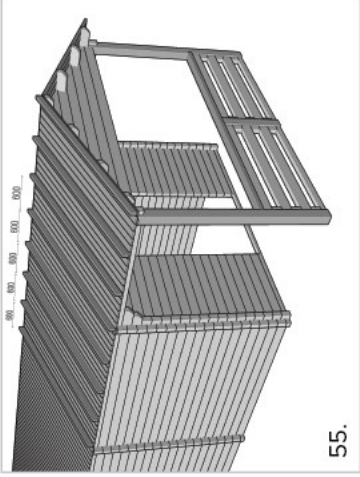

55.

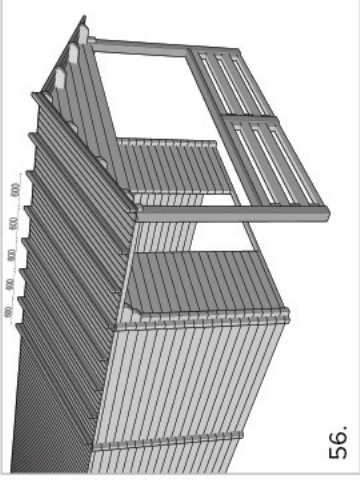

56.

Depending on the roofing, continue by laying either purlins or another layer of roof boards.

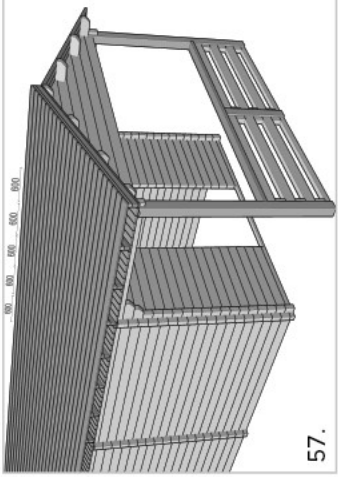

57.

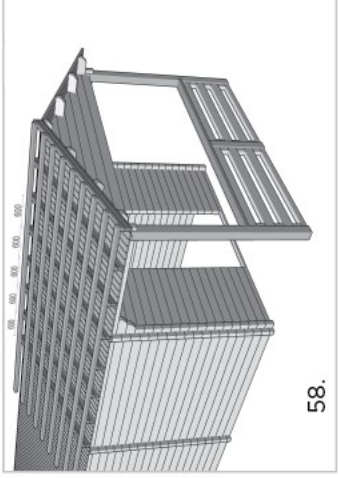

58.

LAYING THE FLOOR

Floor boards should be installed on the beams of the sub-frame and fastened with nails. Fasten the first floor board using two nails on each beam of the sub-frame; the remainder should be fastened with one nail. If you plan to treat the floor boards after installation, you will need to protect them with paper, cardboard or another suitable covering material, as untreated floorboards quickly become soiled. After the floor boards have been installed, fasten the skirting.



IMPORTANT! Lay the floor only once the cabin is finished to avoid dirt on it.



59.

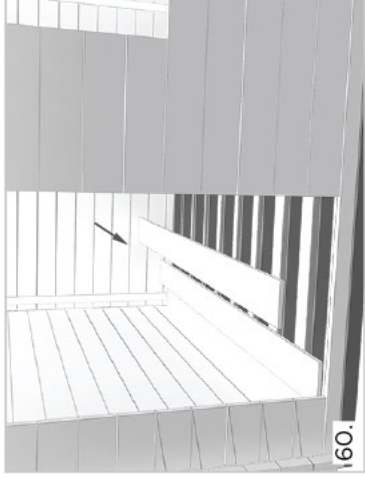

60.

Place floor boards on the joists, taking care to join them well. If needed, carefully push one against another with a hammer. If needed, cut the last boards to size.

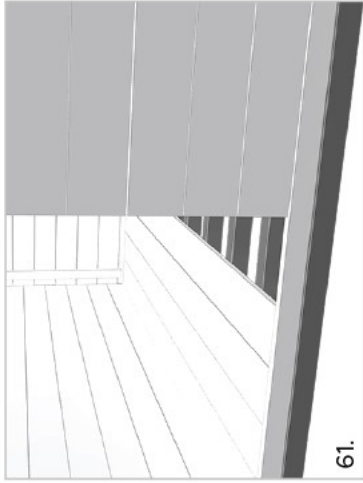

61.

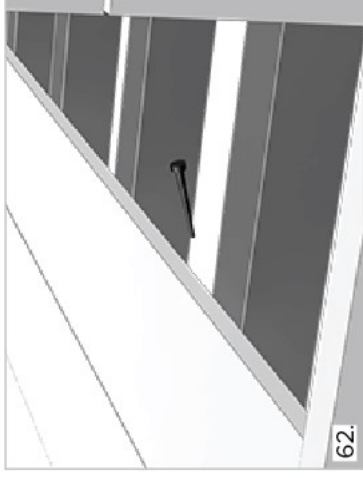

62.

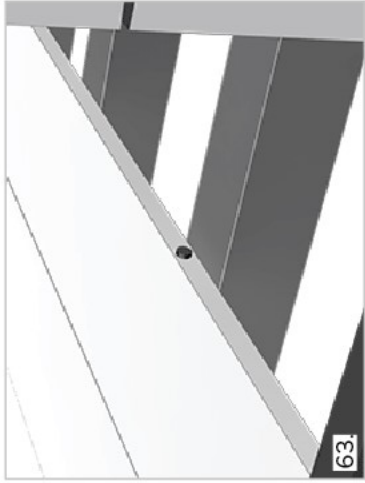

63.



64.

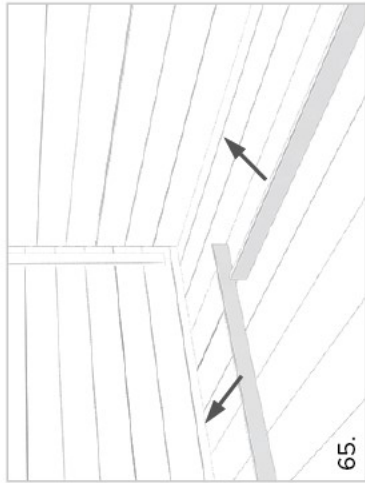

65.

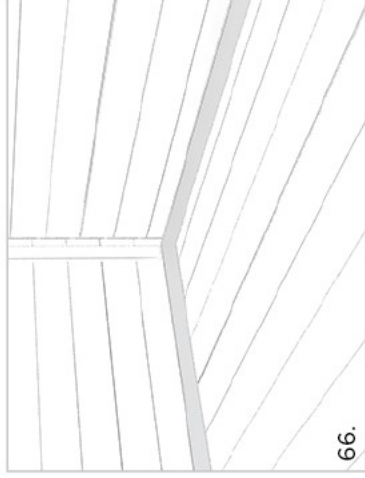

66.

To finish, install the baseboards to hide the connections. If needed, cut them to size.

ASSEMBLY AND MOUNTING OF DOOR FRAMES FOR DOUBLE WALLS

If your house has double outer walls, first assemble the frame (where the door will be fitted later) and then attach two boards on each side and on the top of the frame, as shown in a picture. These boards will go inside, between the double walls around the opening of the door, so bear in mind that they should fit in the gaps perfectly.



34.

Screw the front and back fascia boards.

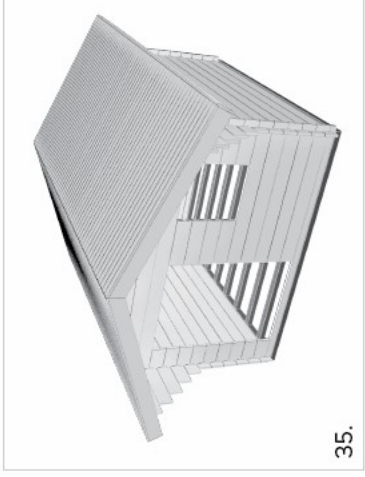

35.

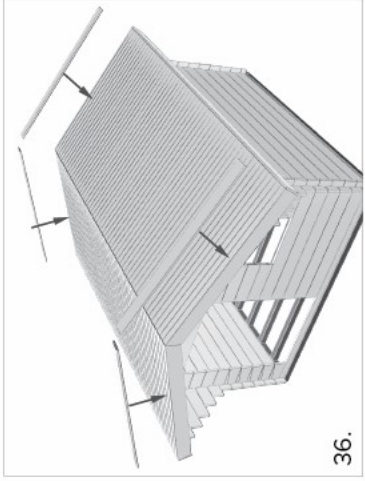

36.

Screw the top fascia boards.



37.



IMPORTANT! Mount the top fascia boards only after you lay the roofing (shingles or other).

LAYING OF THE FLOOR

Floor boards should be installed on the beams of the subframe and fastened with nails. Fasten the first floor board using two nails on each beam of the subframe; the remainder should be fastened with one nail. If you plan to treat the floor boards after installation, you will need to protect them with paper, cardboard or another suitable covering material, as untreated floor boards quickly become soiled. After the floor boards have been installed, fasten the skirting.



IMPORTANT! Lay the floor only once the cabin is finished to avoid dirt on it.



38.

Place floor boards on joist taking care they join well. If needed carefully push them one against another with a hammer. If needed cut last boards to size.

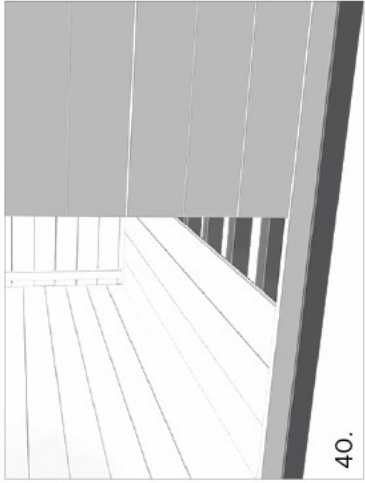

40.

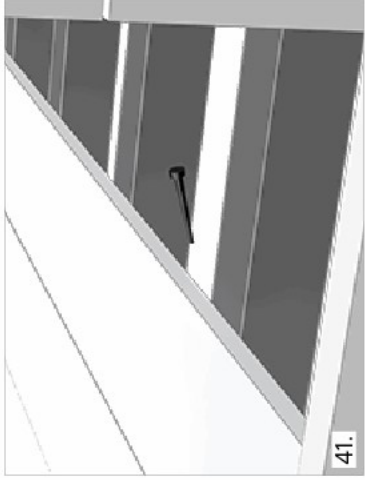

41.

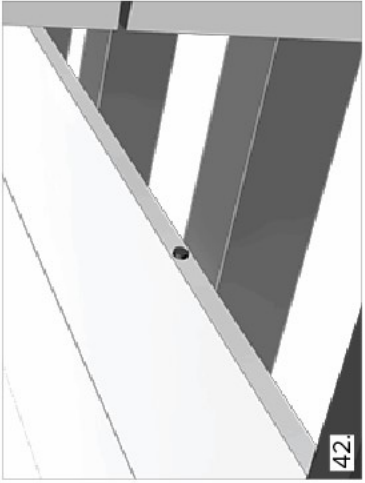

42.



43.

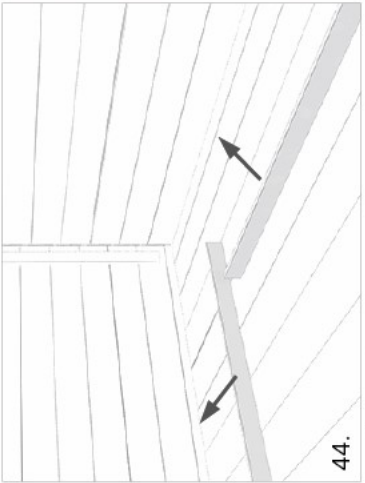

44.

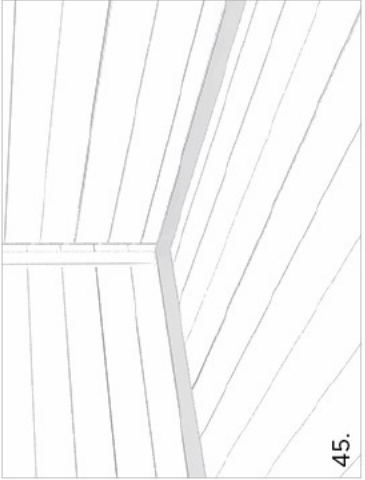

45.

To finish, install the baseboards to hide the connections. If needed, cut them to size.

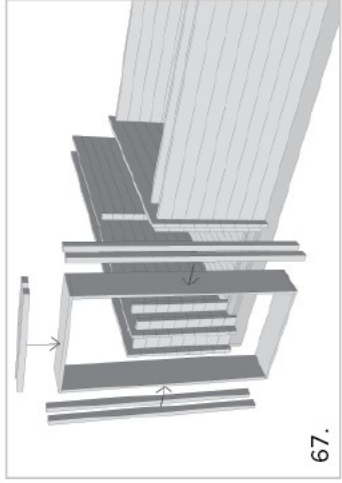

67.

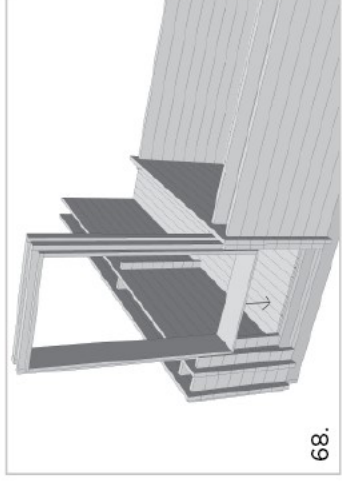

68.

Place the assembled frame in its position while only a few layers of the wall logs are assembled. Do not screw these frames to the wall logs.

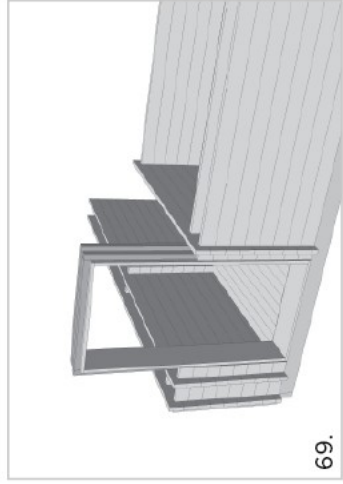

69.

Continue assembling the rest of the wall logs.

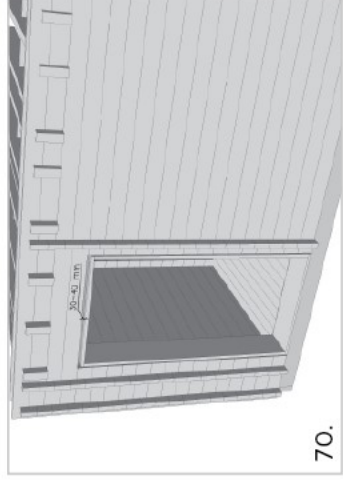

70.

Keep in mind that around 30 to 40 mm gap should be left between the top of the inner frame of the door and the log directly above it.

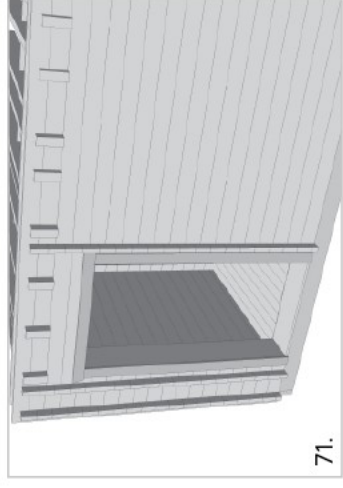

71.

Later, fit the door itself with the architraves.

ASSEMBLY AND MOUNTING OF WINDOW FRAMES FOR DOUBLE WALLS

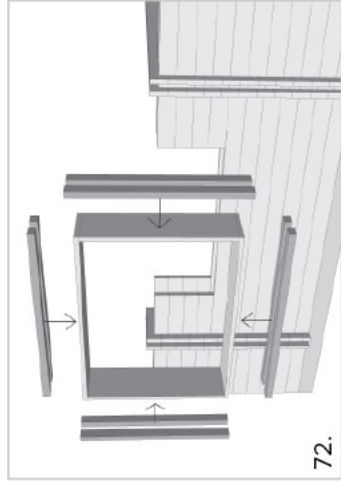

72.

The window frame is assembled exactly in the same way as that of the door, except that in the case of the former, there are also two additional boards underneath the inner frame.

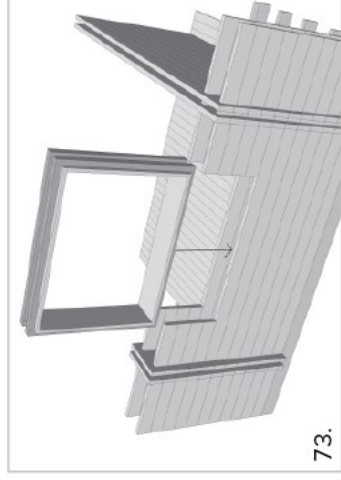

73.

Place the assembled frame in its position. Do not screw these frames to the wall logs.

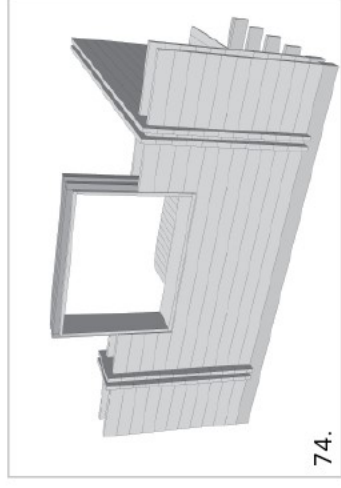

74.

Continue assembling the wall logs.

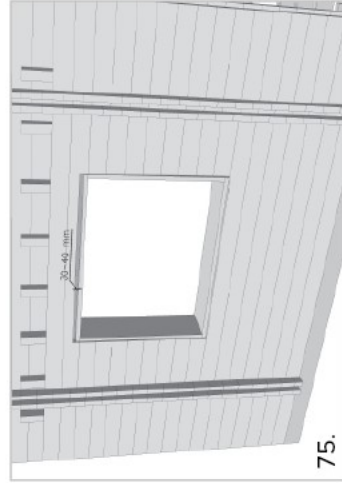

75.

Keep in mind that around 30 to 40 mm gap should be left between the top of the inner frame of the window and the log directly above it.

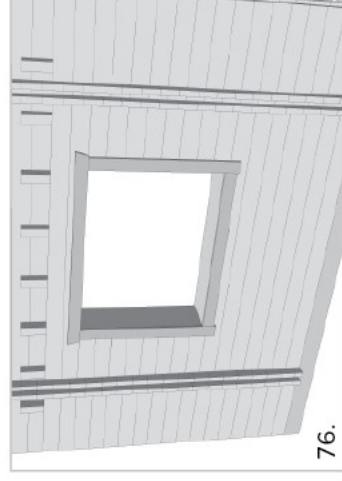

76.

Later, fit the window itself with the architraves.

ASSEMBLY AND MOUNTING OF WINDOWS

Depending on the transport requirements and the type of wooden house, windows can be delivered either disassembled or pre-assembled. For window types delivered in disassembled form, detailed assembly instructions accompany the drawings of the wooden house. Window handles should always remain inside. Cover strips (if included in the assembly set of a window) should be fastened with screws. When installing the windows in the house, ensure they open in the right direction.

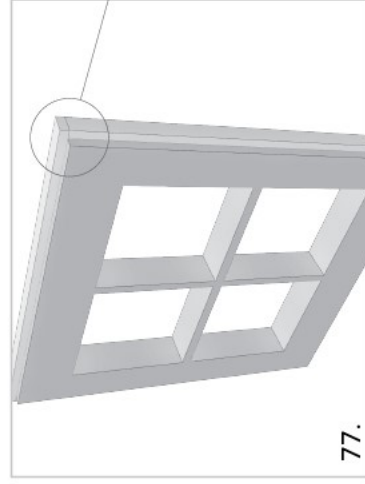

77.



IMPORTANT! Do not screw/nail windows or frame boards to the walls.

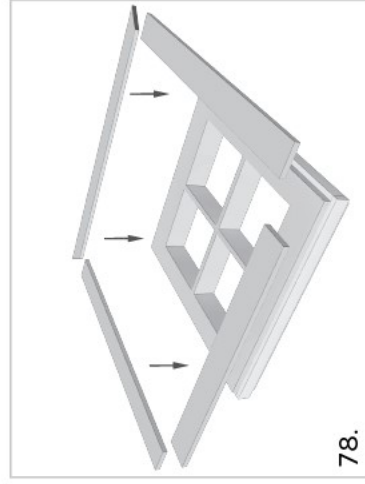

78.

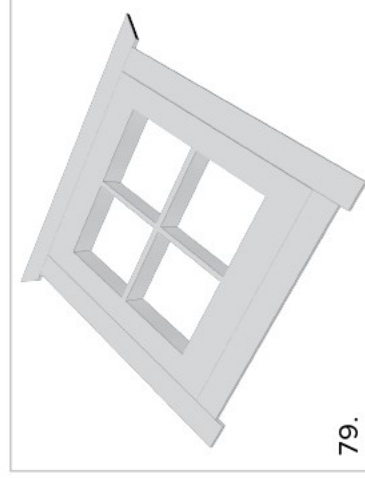

79.

Screw the frame boards on the 2cm frame support around the windows, as in the picture.

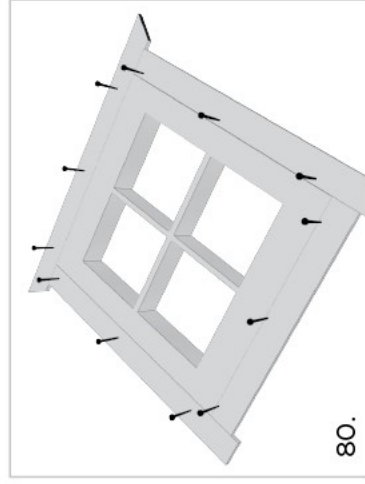

80.

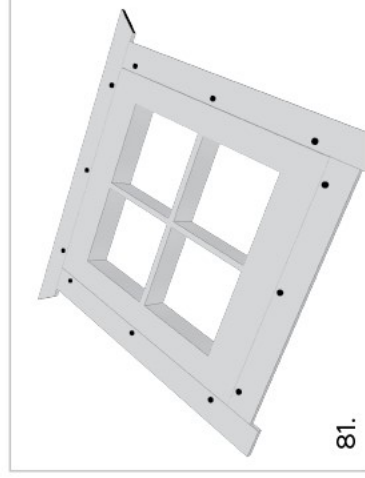

81.

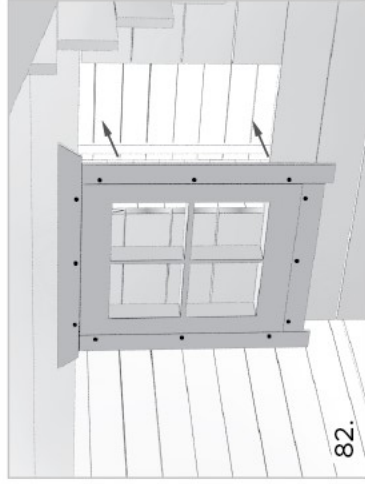

82.

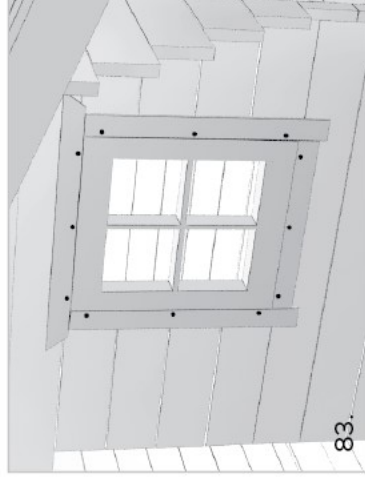

83.

Position the windows in place and screw the frame boards of the other side, following the same process.

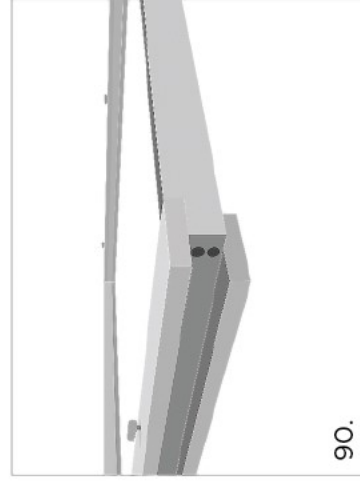
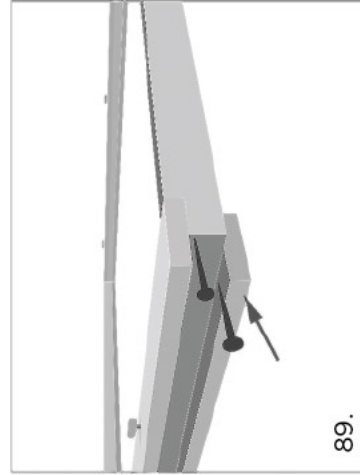
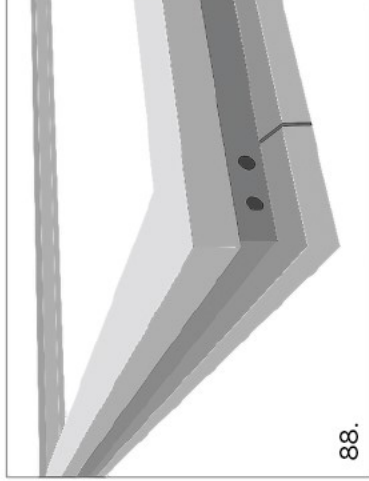
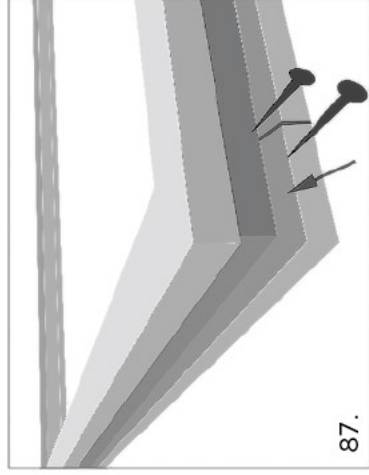
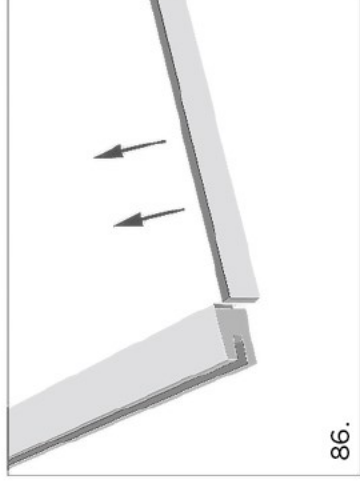
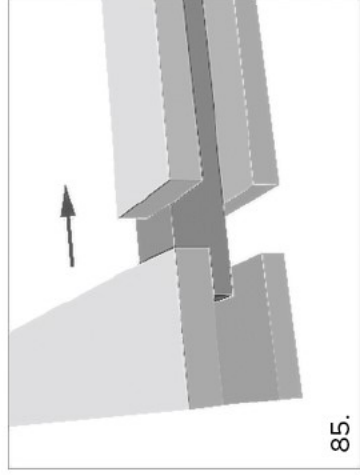
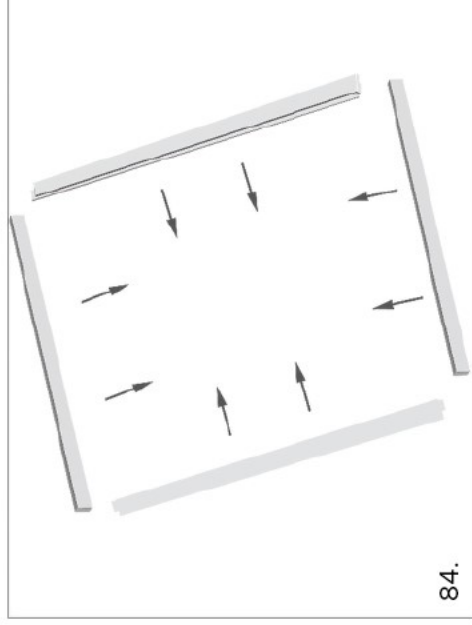

Assemble the door frame and secure it together with screws, as shown in the picture.

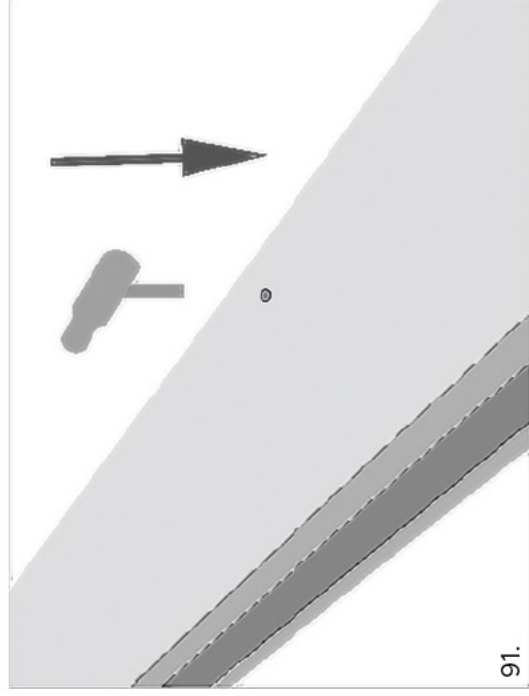

Attach the door hinges to the frame.

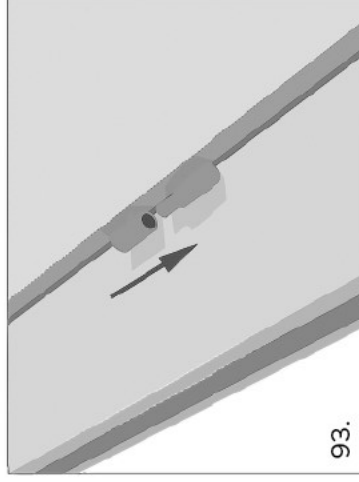
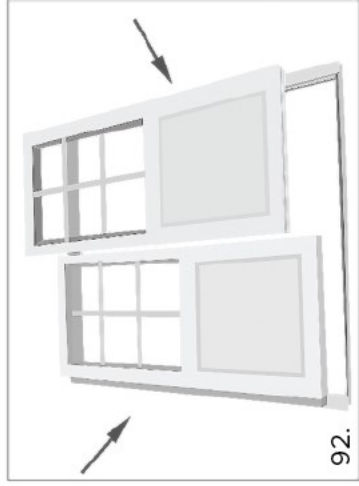

Attach the door to the frame by means of the hinges.

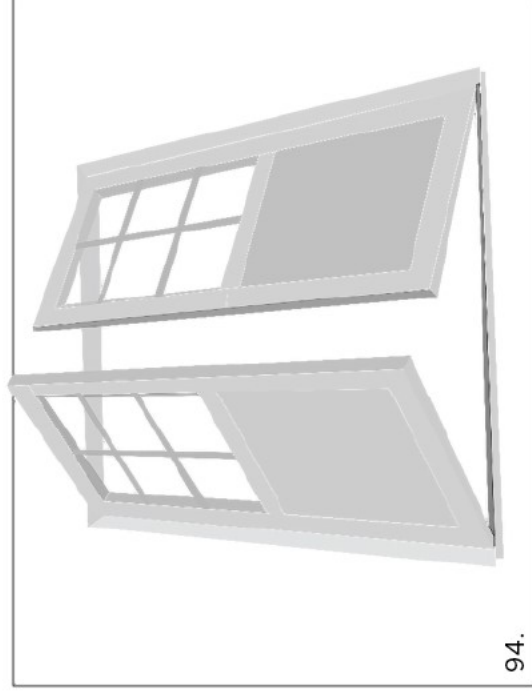



95.

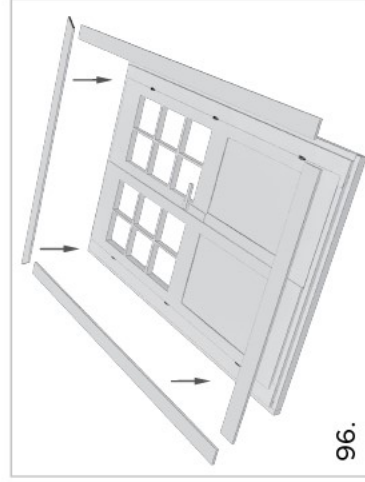
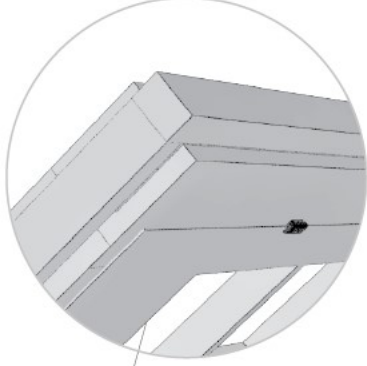

96.

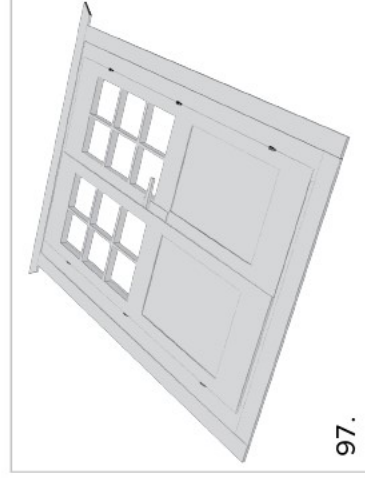

97.

Screw the frame boards on the 2 cm frame support around the doors, as in the picture.

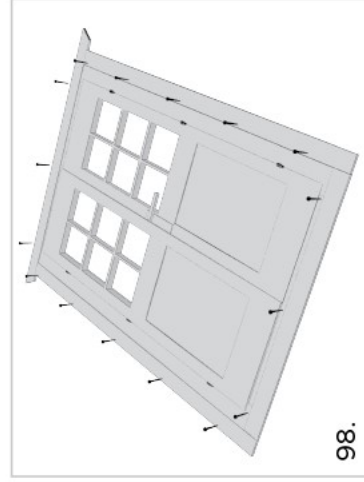

98.

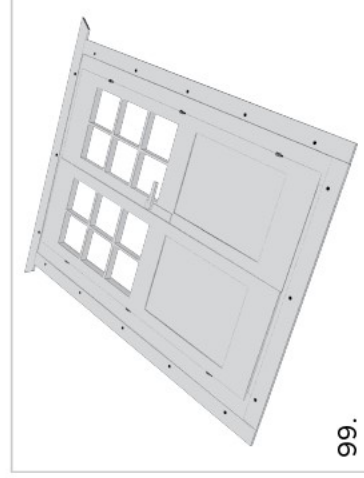

99.



100.



101.

Place the door in its place and screw the frame boards of the other side following the same process.



IMPORTANT! When placing the doors, you must check the diagonals of the doors and adjust them by moving the frame.

WINDOWS ADJUSTMENT INSTRUCTION

For adjustment, you will need

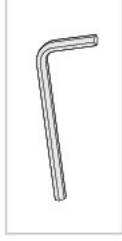

a 4 mm hex key.

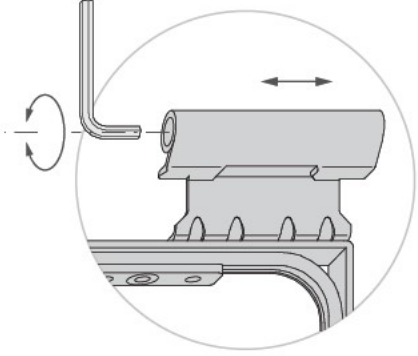

102.

Remove the top cover cap from the hinge. Place and turn the hex key left or right. The window will be tilted up or down accordingly.

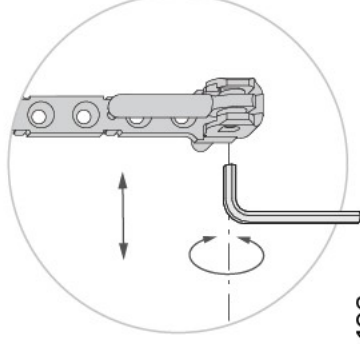

103.

By turning the side regulator, the window will be adjusted to the left or to the right.

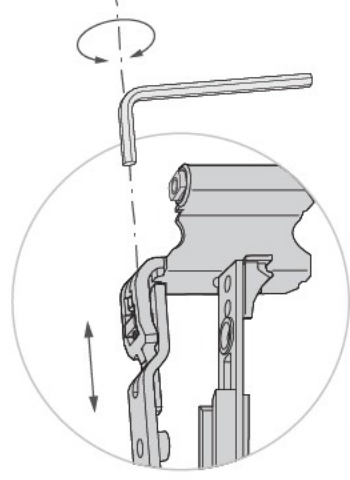

104.

Adjustment of the top hinge of the window hash: as you open the hash, you will see the regulator. By turning the hex key to either side, you will adjust the window hash to either left or right.

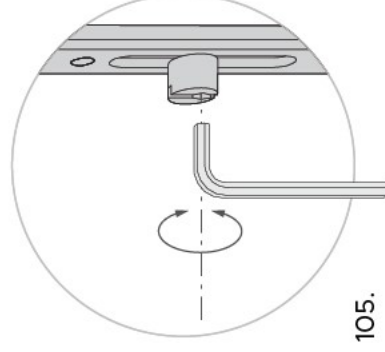

105.

At the side of the hash, there are several regulators. When you adjust these, make sure you turn all the regulators equally. By turning left, you will loosen the hash. By turning right, you will press it tighter.

HOW TO PAINT, VARNISH WINDOWS AND DOORS

Acrylic paints and varnishes are the most suitable for your products. Before painting or varnishing products, please follow the basic painting recommendations:

- WINDOW / DOOR can be painted before installation.
 - Remove and or cover with tape parts that should not be painted (fittings, fixtures, gaskets)
 - Before painting, prepare the surface by wiping the dust with a dry soft cloth.
 - Do not use abrasive or other surface cleaning agents.
 - Use grease removers or primers before painting.
 - Read and follow paint / varnish manufacturer's instructions before applying
 - Do not paint sealing seams, gaskets, latches, handles, plastic trim, silicone seam, insect nets and other moving parts.
 - Only paint open windows and do not close them until the paint has dried. The paint stripper or primer must dry completely before painting.
 - Make sure that the painted surface is not damaged when it is in contact with other surfaces until the paint / varnish is completely dry.
 - Product is considered painted when it is coated on all sides, otherwise it will not be weatherproof or moisture resistant.
- Window or door moving part may become deformed and leak.

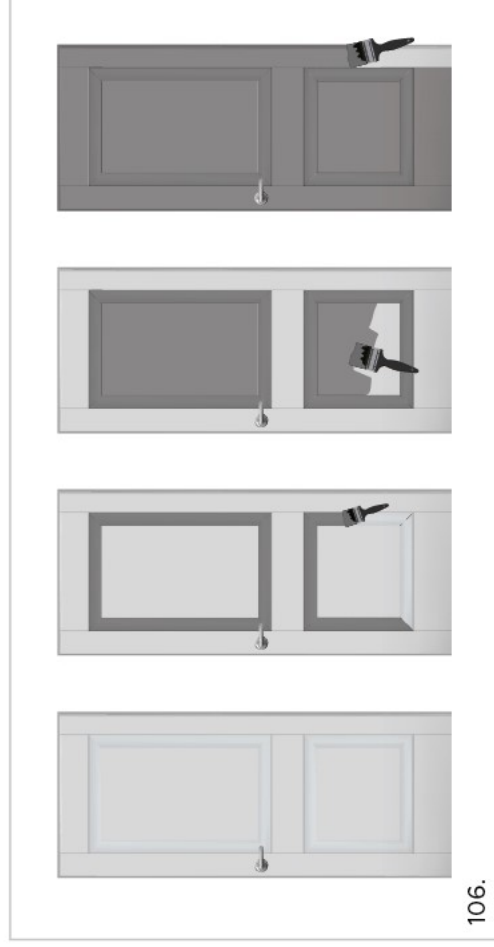

106.



Attention! Sanding, chemical cleaning, painting, varnishing and other finishing work must be carried out in a well-ventilated area.

MAINTAINING GASKETS AND WATER DRAININGS

If your window or door have rubber gaskets, they must be greased with silicone grease at least twice a year (e.g. used to grease car door gaskets). This way the gaskets are not cracked, will be elastic, will not freeze in winter, will fit well to the frame - the window will be tight. When cleaning windows, be sure to clean the gaskets as well. Different debris can tear or deform them. While inspecting and cleaning the gaskets also check for condensate run-out cavities, which are located in the aluminum slab that is attached to the underside of the window frame. If there is debris or dirt in the cavities, be sure to clean it so that any water that enters can run out, otherwise it may accumulate on the frame and run inside.



ATTENTION!

- Window condensation is one of the signs that the temperature / humidity ratio (microclimate) in your home is inadequate.
- Condensation on windows or doors can affect mold formation, deformation of the glazing and frame.
- Windows or doors must be operated in rooms that are not exposed to excessive or insufficient humidity (35%–50% of relative humidity). Do not raise the indoor temperature above 25 ° C during the winter when there is extreme cold outside. Otherwise, the window or door hinges may become deformed and will leak.
- Protect products from debris, dust, glue and paint while inside finishing works are carried out. Failing to do so may damage the product.
- If you cover windows or doors from damage during construction, be careful not to damage the glass and the frame.
- Do not overload, support or lift the window sash to prevent damage to the window or door fittings.
- Do not place any additional objects between the sash and the frame, as this may result in deformation of the window or door frame, fittings.

MAINTAINING FITTINGS

The fittings must be kept clean and greased at all times for proper operation and long-term use. We recommend doing the following couple of times per year (autumn, spring):

- Clean window fittings dry cloth or with mild detergents (e.g. soapy water) and dry them after cleaning. Acid and powder cleaners can damage the hardware's anti-corrosion coating and cause it to start corroding.
- After cleaning, lubricate the moving assemblies and sealing points with grease or oil. Suitable for this is general lubricant oil, sewing machine lubricant.
- Check that the hinges of windows and doors are secure and that they are not sagged. Adjust the windows / doors if necessary
- If the hinges are without cover caps, make sure that the stem of the upper hinge is completely inserted.

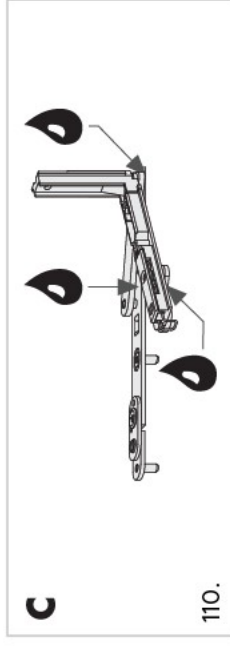
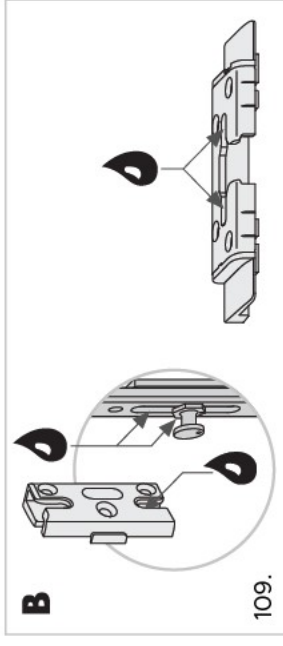
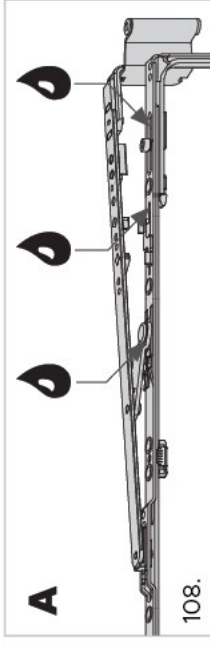
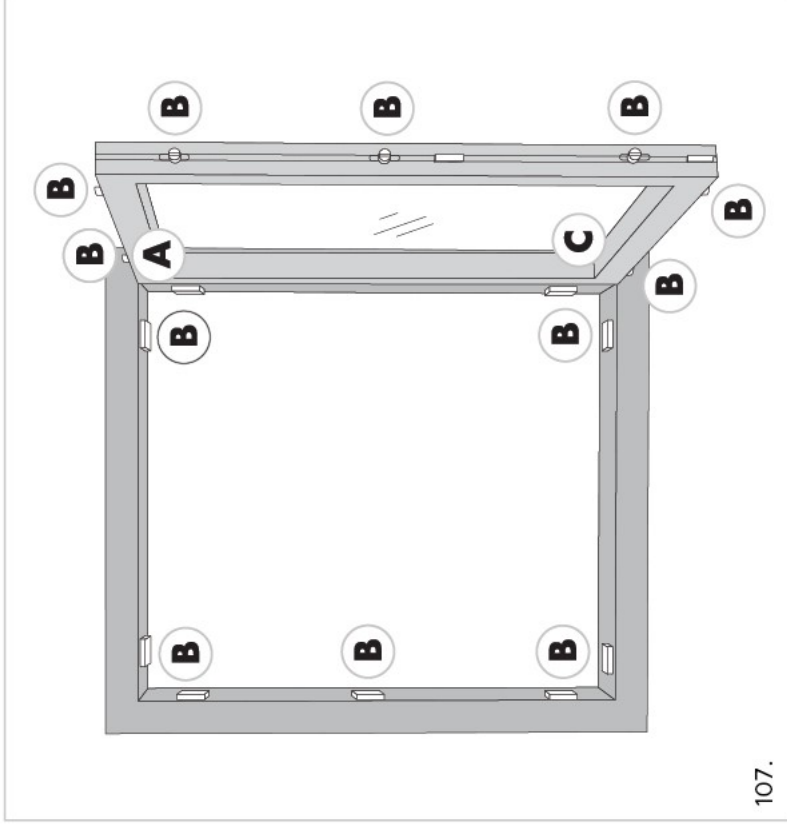

WARRANTY

Your wooden house has a two-year warranty, and we give the wooden wall elements a special extended warranty of five years. You will find the terms and conditions of the warranty below. Repairing or replacing the product during the warranty period will not extend the warranty period or grant a new warranty with a new warranty period. The warranty on elements replaced or repaired during the warranty period expires at the same time as the warranty period of the product.

1. GENERAL WARRANTY CONDITIONS

- 1.1. The wooden house (hereinafter: the Product) shall be purchased from a Manufacturer or an authorised distributor of the Manufacturer (hereinafter: the Seller) and the end-user of the Product (hereinafter: the Buyer) must have fully paid for the Product by the time of the warranty incident.
- 1.2. The Buyer shall ensure that the Product is selected for its intended purpose and is suitable for installation in the planned location (e.g., year-round use as an office).
- 1.3. The warranty period starts from the moment the Product is delivered to the Buyer and the accompanying documents have been signed. The warranty is valid provided that the installation instructions are strictly followed. Modifications made to the Product or parts thereof shall be coordinated in advance with the Seller.
- 1.4. A warranty incident is considered to be a possible fault in the structure of the Product or a defect in and/or missing element which is not excluded from the warranty as per Article 2.
- 1.5. The Seller must be notified immediately of any deficiencies in the Product detected during the warranty period, at the latest within five working days from the date the deficiency was discovered. When submitting a complaint, it must be accompanied by one or more photos, a description of the deficiency, the article number of the Product and the serial number given by the manufacturer (as marked on the page of the Inspection Certificate and on the label attached to the packing).
- 1.6. The scope of warranty liability is exclusively limited to the faulty element to be replaced under warranty. The Buyer and Seller shall agree on the fastest possible delivery date and location. The scope of warranty liability excludes transport, installation, time and communication costs related to the detection of the defect and installation. The Seller shall not be held liable before the Buyer or a third party for any incidental or consequential damage arising from the deficiency in the Product.
- 1.7. In case of doubt, the Seller reserves the right to process the incident for longer than 14 working days and to involve experts, of its own volition, to establish whether the Product was installed according to the provided installation instructions and circumstances exist which exclude the warranty liability described in Article 2.
- 1.8. The Seller has the right to claim compensation from the Buyer for the costs incurred in processing an unjustified complaint.

2. THIS WARRANTY EXCLUDES THE FOLLOWING:

- 2.1. Damage caused by the incorrect storage of the Product after the Product has been delivered to the Buyer (exposed to weather conditions, in contact with the ground or in heated rooms) or damage occurring during transport and installation. Damage occurring during transport (if the Product was delivered to the home address or another address of the Buyer) which can be determined before accepting the goods (i.e., before unloading from the vehicle) shall be recorded by taking one or more photos, which shall be forwarded to the Seller.
- 2.2. Minor transport damage to product elements that does not affect the static functionality of such elements. For example, a broken corner of hipped end in the transport package. This does not compromise static strength and can be easily repaired by using screws or special timber glue to restore proper visual appearance.
- 2.3. Mistakes made during the installation of the Product:
 - the installation instructions were ignored during the installation process;
 - weather conditions (strong wind, snow, ice or rain) which could harm the Product were not taken into consideration during installation;
 - the distance between the upper edge of the foundation or the first wall element of the house is less than 45 mm;
 - the outer edge of the bottom wall row is not installed 5 mm beyond the outer edge of the foundation;
 - the sub-frame is not level and square;
 - no damp-proof barrier has been installed between the foundation and structure;
 - the entire Product has not been finished with wood preservative within 14 days after installation, including the doors and windows, which should be finished on both sides (to prevent discolouration, bending and expanding). When choosing wood preservatives, an expert/paint seller should be consulted;
 - in terms of ensuring the durability of the Product, it has not been sufficiently protected against weather conditions, e.g., by means of roofing covering strips and fastening strips, anchors, storm strips or other means, even if the listed accessories are not included in the wooden house set;
 - objects have been rigidly fastened to a wall which prevents the normal drying, shrinking, settling or expanding of the Product (which must also be taken into consideration when fastening the nut of the storm strip);
 - during installation of the roof boards 1-2 mm of expansion space has not been provided;
 - for roofing felt (if this is included in the wooden house set) meant to be used as an underlayer with the roofing material.We are not responsible for customer-initiated modifications to the wooden houses that may affect both the partial and complete assembly and operation of the house.
- 2.4. Peculiarities of wood as a natural material:
 - expanding, shrinking (below 3% in width and thickness), differences in colour and twisting and bending of elements, none of which hamper the installation of the wooden house;
 - intact/ingrown knots in elements of the Product which do not harm its stability;
 - unplanned areas, dull areas or areas where knots extend beyond the edge of the roof or floor boards of the wooden house, if the boards can be installed so that these defects remain hidden after final finishing (e.g. by rotating the boards);
 - knots with a max. diameter of 20 mm extending beyond the elements of the Product, including its appearance on the edge of an element of the Product, but remain hidden in the structure after final finishing;
 - small fissures or cracks formed in the Product (as a result of drying) which have not penetrated through and do not hamper the stability of the Product's structure;
 - wax pockets in elements of the Product.

WARRANTY

- 2.5. Finger-jointed wooden elements used in the Product.
- 2.6. Damage related to the normal wear and tear of the Product (e.g. signs of wear on floor boards or the doorsill).
- 2.7. Glazed units/glass panes mechanically damaged by the Buyer, broken or thermally broken (which may occur when the difference in temperature of the glass in the central area and in the hidden edge area of a pane or glazed unit exceeds the critical value).
- 2.8. Reasons related to normal physical phenomena. For example, condensation of moisture caused by greater differences between interior and exterior temperatures, and excessive humidity. This mostly affects windows or corners of the wooden house (spots or mould may develop). This can be avoided only by using heating or ventilation systems.
- 2.9. Damage related to unforeseeable factors (e.g., vandalism, flooding, storms or tornadoes).
- 2.10. Product elements installed in an environment that is unsuitable for the product (excessive humidity, temperature differences, etc.). For example, wooden doors (included in delivery) are not designed for wet rooms (like bathrooms or saunas). Using them in wet environments may cause excessive bending or expansion that compromises their functionality.
- 2.11. Damage resulting from negligence whilst using the product. For example, entrance doors that may be flipped open by wind or storm and slammed against the wall or beyond their opening range. This could break the hinges or cause cracks to develop in the wood. We recommend using latches or stoppers (not included in delivery) to avoid this. Excessive snow loads should be removed from the wooden house roof during winter, particularly if there is heavy snowfall or melting which poses a major risk for buildings with a flat or low-pitched roof. Be sure to follow safety precautions if you decide to remove the snow from the roof by yourself. The Buyer shall lose their entitlement to the warranty in the following cases:
- the Buyer does not verify the quantity, completeness and quality of the Product and elements thereof within a reasonable time following delivery and acceptance of the Product and, in all cases, before installation;
 - elements with defects have already been installed or painted, but the deficiency in the Product would have been noticeable during inspection. The detected deficiency shall be recorded as described in article 1.5;
 - and/or the Buyer submits to the Seller wrong or insufficient data regarding the Product or warranty incident or the documents proving the purchase are not submitted.

*In accordance with EU regulations

RECLAMATION FORM

Client's name			
Project's name			
Wall thickness			
Reclamation type			
<input type="checkbox"/>	Missing parts	Number Quantity	_____ _____
<input type="checkbox"/>	Broken parts	Number Quantity	_____ _____
<input type="checkbox"/>	Bad cut	Number Quantity	_____ _____
<input type="checkbox"/>	Other (please describe):		
Specification			
<input type="checkbox"/>	Logs		
<input type="checkbox"/>	Windows		
<input type="checkbox"/>	Doors		
Windows and doors range			
<input type="radio"/>	SILVER line		
<input type="radio"/>	SUPERIOR line		
<input type="radio"/>	PREMIUM line		
Delivery date			
Additional comments:			

**please attach pictures for reference*

Responsible person	E-mail	Phone