



VIKING  
INDUSTRIER

SAUNA CABINS

SAUNA BARRELS

SAUNA PODS

SAUNA CUBES

HOT TUBS

COLD TUBS

# SAUNA PRODUCTS



REAL PRODUCTS FOR REAL PEOPLE

„All people are created equal;  
but nowhere more so than in sauna“

*Finnish saying*

Sauna is not a hobby  
It's a way of LIFE

# SAUNA CABINS

# SAUNA CABIN 4.5 m<sup>2</sup>



This Sauna Cabin of 4.5 m<sup>2</sup> can carry heavy snow loads, making them equally adaptable in the mountains or in the privacy of your backyard. In this tiny sauna cabin is the available convenience of our stylish electric or wood-burning heaters.

Our sauna cabin provides the ultimate in sauna enjoyment. This cabin is constructed of solid, thick spruce log sections that are profiled for a precise fit.

## STANDARD SET

- ..... Wall, floor panels;
- ..... Insulated roof panels;
- ..... Roof covered with bitumen shingles of your selected color;
- ..... 1 double glass window (hexagonal);
- ..... Door with a lock and a hexagon window;
- ..... Sauna benches from deciduous wood;
- ..... Heat-resistant plate for the heater/stove.

## TECHNICAL SPECIFICATION

..... People	..... 5-6 persons
..... Timber	..... Spruce
..... Shape	..... Hexagon
..... Room	..... 1
..... Inside area	..... 4.5 m <sup>2</sup>
..... Sauna room area / volume	..... 4.5 m <sup>2</sup> / 9 m <sup>3</sup>
..... Total height	..... 2712 mm
..... Wall height	..... 1545 mm
..... Floor thickness	..... 18 mm
..... Wall thickness	..... 45 mm
..... External dimension	..... 2740 x 2373 mm
..... Door size	..... 782 x 1630 mm
..... Window size	..... 607 x 607 mm

## OPTIONS

### ROOF COLOR

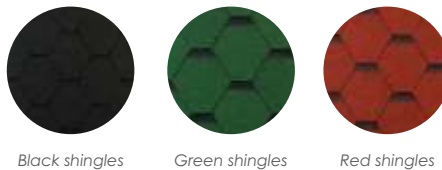

Black shingles      Green shingles      Red shingles

### OTHER OPTIONS

- ..... Exterior painting
- ..... Roof panel with window
- ..... Heater and chimney KIT

## INSIDE PLAN

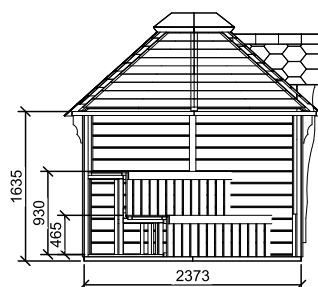
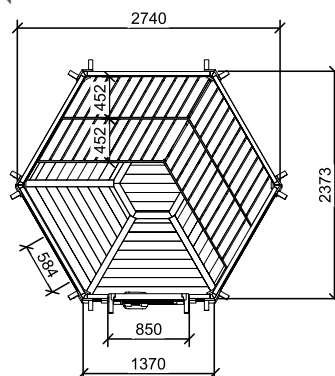

Sauna room volume 9 m<sup>3</sup>



## TRANSPORTATION AND ASSEMBLY

Sauna Cabin is delivered to the customer fully complete but **not assembled**, packed on a pallet (KIT), with detailed assembly instructions, drawings and maintenance recommendations.

**Size of pallet (L x W x H):** 2.35 x 1.20 x 2.40 m.

**Weight:** 980 kg.

**Assembly:** 2 people can assemble Sauna Cabin in **6 hours**.



Sauna Cabin 4.5 m<sup>2</sup> with wood burning heater

# SAUNA CABIN 7 m<sup>2</sup>

ONE OF THE BESTSELLER



Rustic style hooks for opening windows



Sauna benches are made of deciduous wood. This wood does not contain resin

Sauna cabins are very popular and we are happy to offer one of the most petite sizes of cabins - 7 m<sup>2</sup>. We believe in delivering the best, so our sauna cabins come with a lifetime guarantee. It's a perfect place for enjoying relaxation with a few friends. Our sauna cabins are built based on the design of a grill cabin. It has six roof parts, six walls (two with square double-glazed windows), a wooden door, and wide sauna benches.

## STANDARD SET

- ..... Wall, floor panels;
- ..... Insulated roof panels;
- ..... Roof covered with bitumen shingles of your selected color;
- ..... 2 double glass windows;
- ..... Door with a lock and window;
- ..... Sauna benches from deciduous wood;
- ..... Heat-resistant plate for the heater/stove;
- ..... Safety fence for the heater/stove.

## TECHNICAL SPECIFICATION

..... People	5-7 persons
..... Timber	Spruce
..... Shape	Hexagon
..... Room	1
..... Inside area	7 m <sup>2</sup>
..... Sauna room area / volume	7 m <sup>2</sup> / 13 m <sup>3</sup>
..... Total height	3530 mm
..... Wall height	1415 mm
..... Floor thickness	18 mm
..... Wall thickness	45 mm
..... External dimension	3200 x 2771 mm
..... Door size	780 x 1760 mm
..... Window size	670 x 380 mm

## OPTIONS

### ROOF COLOR

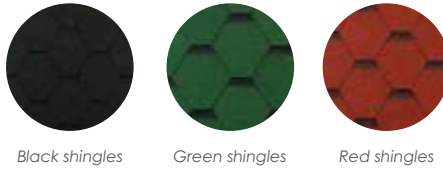

Black shingles

Green shingles

Red shingles

### OTHER OPTIONS

- ..... Exterior painting
- ..... Heater and chimney KIT

### TRANSPORTATION AND ASSEMBLY

Sauna Cabin is delivered to the customer fully complete but **not assembled**, packed on a pallet (KIT), with detailed assembly instructions, drawings and maintenance recommendations.  
**Size of pallet (L x W x H):** 3 x 1.20 x 2.50 m.  
**Weight:** 1300 kg.  
**Assembly:** 2 people can assemble Sauna Cabin in **8 hours**.



## INSIDE PLAN

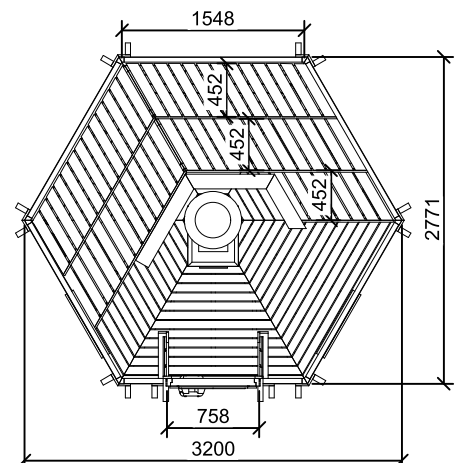

Stylish diamond-shaped window in the door



Sauna Cabin 7 m<sup>2</sup> with wood-burning heater Harvia M3 and water tank (22 l)

# SAUNA CABIN 9.2 m<sup>2</sup>



Sauna room volume 19 m<sup>3</sup>

Finnish saunas, tracing their history to old smoke saunas built from logs, today are highly popular all around the world. As they have become a part of everyday lives, we offer a range of beautiful saunas. Our sauna cabins are built based on the design of a grill cabin. It has six roof parts, six walls (two of them with hexagonal double-glazed windows), a wooden door, and wide sauna benches.

## STANDARD SET

- ..... Wall, floor panels;
- ..... Insulated roof panels;
- ..... Roof covered with bitumen shingles of your selected color;
- ..... 2 hexagon double glass windows;
- ..... Door with a lock and a hexagon window;
- ..... Sauna benches from deciduous wood;
- ..... Heat-resistant plate for the heater/stove;
- ..... Safety fence for the heater/stove.

## TECHNICAL SPECIFICATION

People	6-8 persons
Timber	Spruce
Shape	Hexagon
Room	1
Inside area	9.2 m <sup>2</sup>
Sauna room area / volume	9.2 m <sup>2</sup> / 19 m <sup>3</sup>
Total height	3395 mm
Wall height	1415 mm
Floor thickness	18 mm
Wall thickness	45 mm
External dimension	3256 x 3760 mm
Door size	780 x 1760 mm
Window size	607 x 607 mm

## OPTIONS

### ROOF COLOR

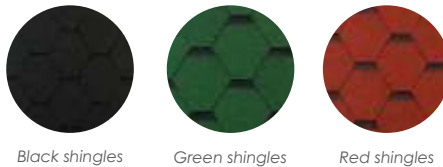

### TRANSPORTATION AND ASSEMBLY

Sauna Cabin is delivered to the customer fully complete but **not assembled**, packed on a pallet (KIT), with detailed assembly instructions, drawings and maintenance recommendations.  
**Size of pallet (L x W x H):** 3 x 1.20 x 2.55 m.  
**Weight:** 1400 kg.  
**Assembly:** 2 people can assemble Sauna Cabin in **9 hours**.

### OTHER OPTIONS

- ..... Exterior Painting
- ..... Heater and chimney KIT
- ..... Roof panel with window
- ..... Tongue and groove floor



Sauna door with hexagonal window

## INSIDE PLAN

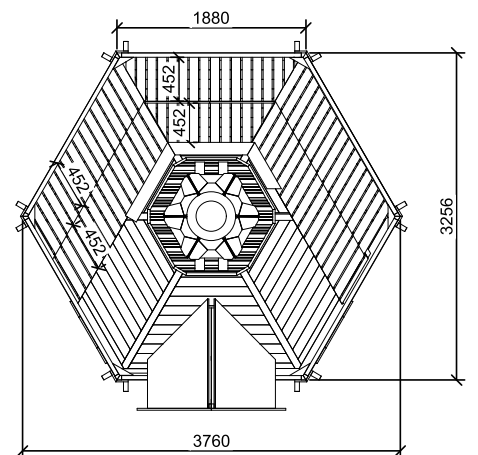

## VIKING TIP!

### USE FRAGRANCE.

Aromatherapy oil such as eucalyptus, pine, citrus, lavender or peppermint can add to your experience in the sauna. The benefits of using these oils vary. Eucalyptus is the favorite scent for its clean and natural aroma. Lavender is good for tension relief.





Sauna Cabin 9.2 m<sup>2</sup> inside with electric heater  
Harvia Cilindro PC90XE

# SAUNA CABIN 9.2 m<sup>2</sup>

## WITH CHANGING ROOM

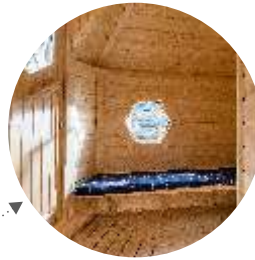

Two rooms inside:  
the changing and the sauna rooms.

The interior is arranged for comfortable and safe bathing in the sauna. Inside you can find two-tier wide sauna benches along three walls, an electric heater to the wall, and a protective fence installed near the heater. The sauna cabin is lockable, and at the entrance, there is a small porch with a roof.

### STANDARD SET

- ..... Wall, floor panels;
- ..... Insulated roof panels over the sauna room;
- ..... Roof covered with bitumen shingles of your selected color;
- ..... 2 hexagon double glass windows;
- ..... Door with a lock and a hexagon window;
- ..... Sauna benches from deciduous wood;
- ..... Safety fence for the heater/stove;
- ..... Heat-resistant plate for the heater/stove;
- ..... Tempered glass door for sauna room;
- ..... Sitting bench in changing room.

### TECHNICAL SPECIFICATION

..... People	6-8 persons
..... Timber	Spruce
..... Shape	Hexagon
..... Room	2
..... Inside area	9.2 m <sup>2</sup>
..... Sauna room area / volume	9.2 m <sup>2</sup> / 11 m <sup>3</sup>
..... Total height	3395 mm
..... Wall height	1415 mm
..... Floor thickness	18 mm
..... Wall thickness	45 mm
..... External dimension	3256 x 3760 mm
..... Door size	780 x 1760 mm
..... Window size	590 x 510 mm
..... Interior tinted glass door	620 x 1600 mm

### OPTIONS

#### ROOF COLOR



Black shingles



Green shingles



Red shingles

#### OTHER OPTIONS

- ..... **Cushions.** Brown or blue color
- ..... **Benches.** With or without changing room benche
- ..... Exterior Painting
- ..... Heater and chimney KIT

#### TRANSPORTATION AND ASSEMBLY

Sauna Cabin is delivered to the customer fully complete but **not assembled**, packed on a pallet (KIT), with detailed assembly instructions, drawings and maintenance recommendations.

**Size of pallets (L x W x H):** 2.40 x 1.20 x 2.50 m;  
2.50 x 1.20 x 2.10 m.

**Weight:** 1450 kg.

**Assembly:** 2 people can assemble Sauna Cabin in **10 hours**.



Inside door from tempered glass



### INSIDE PLAN

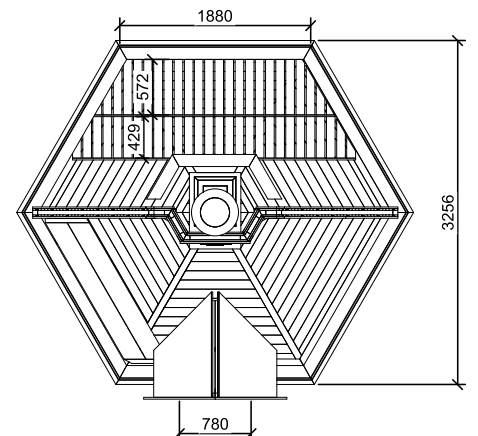



Sauna Cabin 9.2 m<sup>2</sup> with a changing room

# SAUNA CABIN 16.5 m<sup>2</sup>



Grill included in standard set

Spacious lounge area



Do you want to not only bathe in a sauna but also take a rest or organize a small party and have some grilled food? Sauna cabin 16.5 m<sup>2</sup> will be perfect for you because it has both a sauna and a room with a grill for pleasant rest after a bath.

The lounge area is equipped with three benches covered with specially designed cushions. It has a grill with a table around it and a chimney above the grill.

## STANDARD SET

Wall, floor panels;

Insulated roof panels over the sauna room;

Roof covered with bitumen shingles of your selected color;

3 double glass windows (1 of them is opening);

Door with a lock and a hexagon window;

Two rooms inside: a sauna room and a grill room;

Inside grill with adjustable chimney, the cooking platforms and a table around the grill;

Changing room benches with cushions;

Sauna benches from deciduous wood;

Tempered glass door for sauna room;

Heat-resistant plate for the heater/stove.

## OPTIONS

### ROOF COLOR



Black shingles



Green shingles



Red shingles

### GRILL AND CHIMNEY SET

Standard 8-corner grill and chimney

"Viking" grill and chimney

Luxury grill and chimney

"Premium" 8-corner grill and chimney set

Available **without** grill and chimney set

### OTHER OPTIONS

**Cushions.** Brown or blue color

**Benches.** With or without changing room benches

Exterior Painting

Heater and chimney KIT

### TRANSPORTATION AND ASSEMBLY

Sauna Cabin is delivered to the customer fully complete but **not assembled**, packed on a pallet (KIT), with detailed assembly instructions, drawings and maintenance recommendations.

**Size of pallets (L x W x H):** 3.50 x 1.20 x 2.55 m;  
2.50 x 1.20 x 2.55 m.

**Weight:** 2200 kg.

**Assembly:** 2 people can easily assemble Sauna Cabin in **9 hours**.

## TECHNICAL SPECIFICATION

People	10-15 persons
Timber	Spruce
Shape	Octagonal
Room	2
Inside area	16.5 m <sup>2</sup>
Sauna room area / volume	9.2 m <sup>2</sup> / 14 m <sup>3</sup>
Total height	3819 mm
Wall height	1415 mm
Floor thickness	18 mm
Wall thickness	45 mm
External dimension	4538 x 4538 mm
Door size	780 x 1760 mm
Window size	870 x 510 mm
Interior tinted glass door	620 x 1600 mm



## INSIDE PLAN

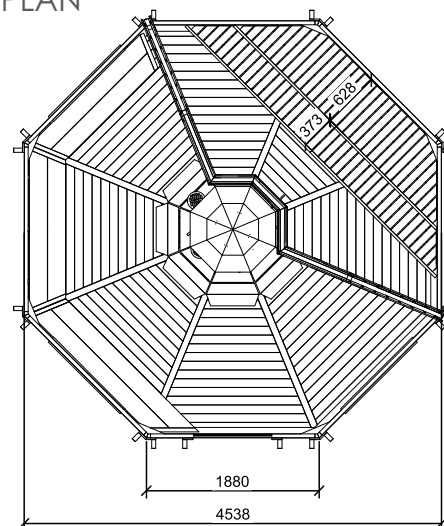



Sauna Cabin 16.5 m<sup>2</sup> inside. Changing room with standard 8 corners Grill and Chimney KIT



Eye catching design.  
Functionality and high-quality.

# SAUNA BARRELS



Sauna Barrel (thermo wood) Ø1.9 x 2.5 m  
LAYOUT PLAN: Without terrace / 2.22 m sauna room

# SAUNA BARREL $\varnothing 1.9 \times 1.63 \text{ m}$ $\varnothing 1.9 \times 2 \text{ m}$

You can choose roof color

2 m long sauna barrel with 2 tempered glass windows in the back wall



1.63 m long sauna barrel with tempered glass window in the back wall

WILL FIT IN ANY GARDEN

These unique Sauna Barrels 2 m or 1.63 m in length and 1.9 m in diameter, can freely fit in any size of the garden. The Barrel can be assembled from start to finish in just eight hours. The Sauna Barrel can be made of **spruce** wood or **thermo**.

## STANDARD SET $\varnothing 1.9 \times 1.63 \text{ m}$

Sauna Barrel from spruce;  
Roof covered with bitumen shingles of your selected color;  
Stainless steel tightening bands;  
Tempered glass window in the back wall (brown);  
Door with a lock and a tempered glass window;  
Sauna benches;  
Heat-resistant plates for the heater/stove.

## TECHNICAL SPECIFICATION

People	2 persons
Timber	Spruce
Shape	Round
Room	1
Sauna room volume	4.1 m <sup>3</sup>
Total height	2100 mm
Floor thickness	18 mm
Wall thickness	38 mm
External dimension	1938 x 1630 mm
Door size	690 x 1600 mm
Window size	1600 x 690 mm

## STANDARD SET $\varnothing 1.9 \times 2 \text{ m}$

Sauna Barrel from spruce or thermowood;  
Roof covered with bitumen shingles of your selected color;  
Stainless steel tightening bands;  
2 tempered glass windows in the back wall (brown);  
Door with a lock and a tempered glass window;  
Sauna benches;  
Heat-resistant plates for the heater/stove.

## TECHNICAL SPECIFICATION

People	2-4 persons
Timber	Spruce / Thermowood
Shape	Round
Room	1
Sauna room volume	5 m <sup>3</sup>
Total height	2100 mm
Floor thickness	18 mm
Wall thickness	38 mm
External dimension	1933 x 2000 mm
Door size	690 x 1600 mm
Window size	213 x 665 mm

## OPTIONS

### AVAILABLE THICKNESS OF THE SIDE BOARDS

38 mm boards from spruce (standard)  
58 mm boards from spruce (available)  
38 mm boards from thermowood (for 2 m long sauna) (available)

### AVAILABLE WINDOWS only for 2 m long sauna

2 rectangular windows in back wall (standard)  
2 windows in front wall  
2 in front and 2 in back wall  
Without windows in front, with big windows in back  
2 in front and big windows in back  
Full glass back wall, without windows in front  
Full glass back wall and 2 windows in front  
Half glass back wall for  $\varnothing 1.90 \text{ m}$ , without windows in front  
Half glass back wall with 2 windows in front

### AVAILABLE FRONT DOOR

Wooden door with tempered glass window  
**(standard)**  
Wooden door with large rectangular tempered glass window  
Tempered glass door

### OTHER OPTIONS

Exterior painting.  
Led lighting (for assembled product).

### TRANSPORTATION AND ASSEMBLY

$\varnothing 1.9 \times 1.63 \text{ m}$  size sauna.  
**Not assembled, KIT (L x W x H):** 2 x 1.20 x 1.30 m.  
**Assembled (L x W x H):** 1.69 x 2.03 x 2.09 m.  
 $\varnothing 1.9 \times 2 \text{ m}$  size sauna.  
**Not assembled, KIT (L x W x H):** 2 x 1.20 x 1.30 m.  
**Assembled (L x W x H):** 2.06 x 2.03 x 2.09 m.  
**Weight:** 500 - 600 kg.  
**Assembly:** 2 people can assemble in **8 hours**.

## INSIDE PLAN

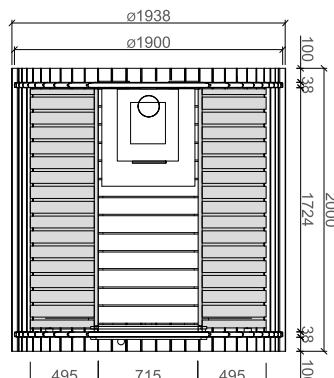
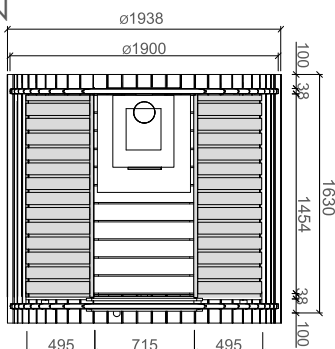



Sauna Barrel Ø1.9 x 3 m with full glass back wall and wood-burning heater Harvia M3

# SAUNA BARREL Ø1.9 X 3.5 m



WITH CHANGING ROOM

## STANDARD SET

Sauna Barrel from spruce or thermowood;  
Roof covered with bitumen shingles of your selected color;

Stainless steel tightening bands;

2 tempered glass windows in the back wall

(brown);

Door with a lock and a tempered glass window;

Sauna benches;

For the saunas with a changing room inside

benches;

For the saunas with a changing room inside glass

door;

Heat-resistant plates for the heater/stove.

## TECHNICAL SPECIFICATION

People	6-8 persons
Timber	Spruce / Thermowood
Shape	Round
Room	1 or 2
1.88 m length sauna room volume	7 m <sup>3</sup>
2.72 m length sauna room volume	8 m <sup>3</sup>
2.38 m length sauna room volume	9 m <sup>3</sup>
3.22 m length sauna room volume	7 m <sup>3</sup>
Total height	2100 mm
Floor thickness	18 mm
Wall thickness	38 mm
External dimension	1938 x 3500 mm
Door size	690 x 1600 mm
Interior tinted glass door	688 x 1650 mm
Window size	213 x 665 mm

## TRANSPORTATION AND ASSEMBLY

**Not assembled, KIT (L x W x H):** 3.50 x 1.20 x 1.30 m.

**Assembled (L x W x H):** 3.56 x 2.03 x 2.09 m.

**Weight:** 700-900 kg; **Assembly:** 2 people in 8 hours.

## OPTIONS

### ROOF COLOR



Black shingles



Green shingles



Red shingles

### AVAILABLE THICKNESS OF THE SIDE BOARDS

38 mm boards from spruce (standard)

58 mm boards from spruce (available)

38 mm boards from thermowood (available)

### AVAILABLE WINDOWS

2 rectangular windows in back wall (standard)

2 windows in front wall

2 in front and 2 in back wall

Without windows in front, with big windows in back

2 in front and big windows in back

Full glass back wall, without windows in front

Full glass back wall and 2 windows in front

Half glass back wall without windows in front

Half glass back wall with 2 windows in front

### AVAILABLE FRONT DOOR

Wooden door with tempered glass window (standard)

Wooden door with large rectangular tempered glass window

Tempered glass door

### OTHER OPTIONS

Exterior painting.

Led lighting (for assembled product).

Barrel sauna can be made of spruce or thermo wood. Upon the customer's request, we can install a wood-fired or an electric heater in the sauna.

Also, there are 5 layout options for this sauna barrel: with or without the terrace, with or without a changing room, which means shorter or longer saunaroom.

## INSIDE PLAN

### AVAILABLE LAYOUT

1. With 0.60 m terrace at the front, 0.80 m length changing room, 1.88 m sauna room (7 m<sup>3</sup>)

2. With 0.60 m terrace at the front, 2.72 m sauna room (8 m<sup>3</sup>)

3. With 0.80 m changing room and 2.38 m length sauna room (9 m<sup>3</sup>)

4. With 1.30 m changing room and 1.88 m length sauna room (9 m<sup>3</sup>)

5. With 3.22 m length sauna room (11 m<sup>3</sup>)

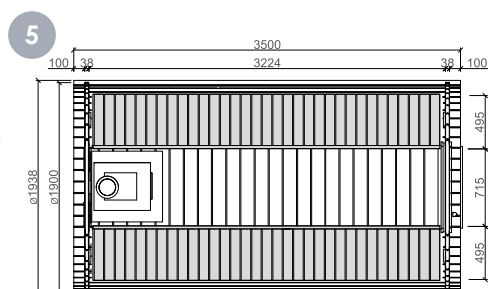
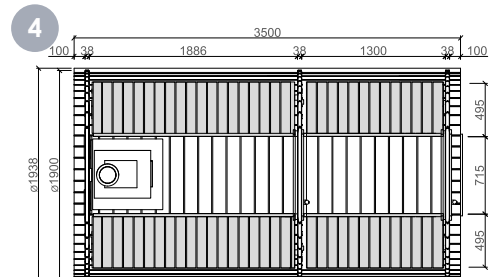
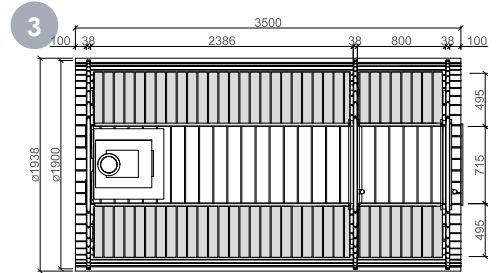
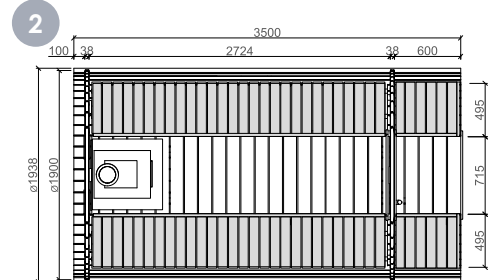
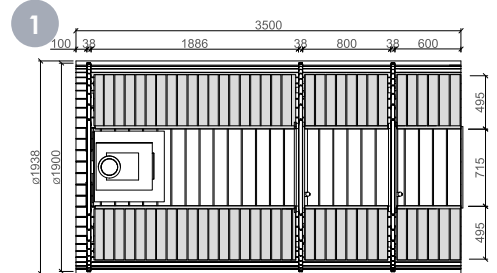



Sauna Barrel (spruce wood) Ø1.9 x 3.5 m  
LAYOUT PLAN: Without terrace / 3.2 m sauna room

# SAUNA BARREL Ø2.2 X 3.5 m



WITH CHANGING ROOM

Available to choose from three different types of front door

Available with or without terrace at front



Restore, body and soul, without going to the spa!  
Two-room sauna has a separate changing room and a sauna room that allows up to 8 persons to enjoy sauna benefits at once!

## INSIDE PLAN

### AVAILABLE LAYOUT

1. With 0.60 m terrace at the front, 0.80 m length changing room, 1.88 m sauna room (7 m<sup>3</sup>)
2. With 0.60 m terrace at the front, 2.72 m sauna room (10 m<sup>3</sup>)
3. With 0.80 m changing room and 2.38 m length sauna room (9 m<sup>3</sup>)
4. With 1.30 m changing room and 1.88 m length sauna room (7 m<sup>3</sup>)
5. With 3.22 m length sauna room (12 m<sup>3</sup>)

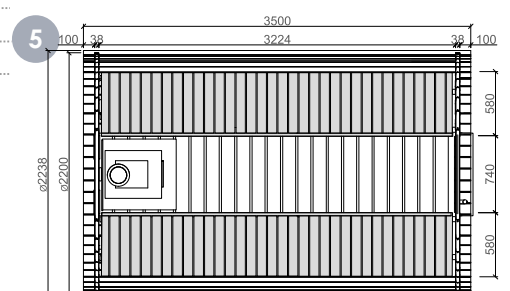
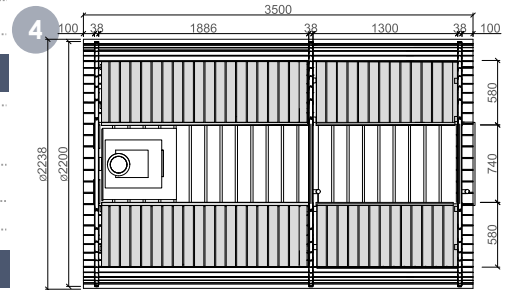
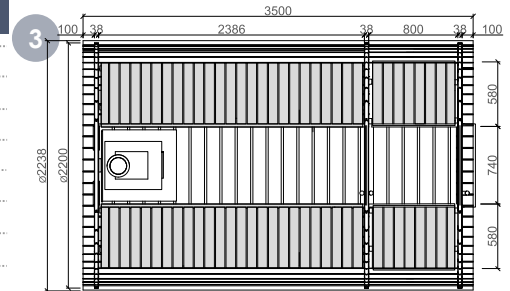
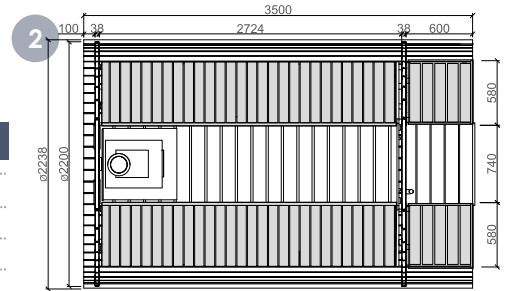
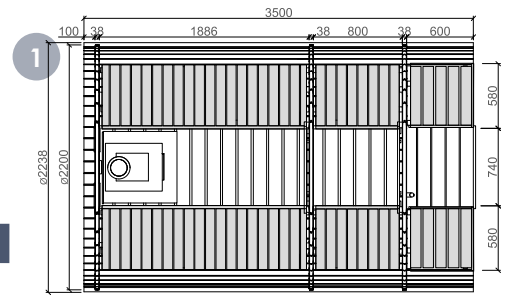

## STANDARD SET

- Sauna Barrel from spruce or thermowood;
- Roof covered with bitumen shingles of your selected color;
- Stainless steel tightening bands;
- 2 tempered glass windows in the back wall (brown);
- Door with a lock and a tempered glass window;
- Sauna benches;
- For the saunas with a changing room inside benches;
- For the saunas with a changing room inside glass door;
- Heat-resistant plates for the heater/stove.

## TECHNICAL SPECIFICATION

People	6-8 persons
Timber	Spruce / Thermowood
Shape	Round
Room	1 or 2
1.88 m length sauna room volume	7 m <sup>3</sup>
2.72 m length sauna room volume	10 m <sup>3</sup>
2.38 m length sauna room volume	9 m <sup>3</sup>
3.22 m length sauna room volume	12 m <sup>3</sup>
Total height	2400 mm
Floor thickness	18 mm
Wall thickness	38 mm
External dimension	2238 x 3500 mm
Door size	690 x 1800 mm
Interior tinted glass door	685 x 1850 mm
Window size	213 x 665 mm

## OPTIONS

### ROOF COLOR

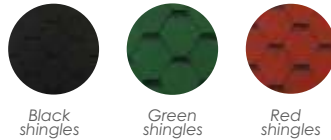

### AVAILABLE THICKNESS OF THE SIDE BOARDS

- 38 mm boards from spruce (standard)
- 58 mm boards from spruce (available)
- 38 mm boards from thermowood (available)

### AVAILABLE WINDOWS

- 2 rectangular windows in back wall (standard)
- 2 windows in front wall
- 2 in front and 2 in back wall
- Without front windows, with big windows in back
- 2 in front and big windows in back
- Full glass back wall, without windows in front
- Full glass back wall and 2 windows in front
- Half glass back wall without windows in front
- Half glass back wall with 2 windows in front

### AVAILABLE FRONT DOOR

- Wooden door with tempered glass window (standard)
- Wooden door with large window
- Tempered glass door

### OTHER OPTIONS

- Exterior painting.
- Led lighting (for assembled product).

### TRANSPORTATION AND ASSEMBLY

- Not assembled, KIT (L x W x H): 3.50 x 1.20 x 1.40 m.
- Assembled (L x W x H): 3.56 x 2.32 x 2.40 m.
- Weight: 700-900 kg; Assembly: 2 people in 8 hours.



# SAUNA BARREL Ø2.2 X 4 m



Available to order sauna with eco friendly roof (wooden shingles)

Half glass back wall (as option)



Sauna barrels with the glass back wall are delivered only fully assembled

3 types of plan layouts

## STANDARD SET

- .....
- Sauna Barrel from spruce or thermowood;
- .....
- Roof covered with bitumen shingles of your selected color or wooden shingles;
- .....
- Stainless steel tightening bands;
- .....
- 2 tempered glass windows in the back wall (brown);
- .....
- Door with a lock and a tempered glass window;
- .....
- Sauna benches;
- .....
- For the saunas with a changing room inside benches;
- .....
- For the saunas with a changing room inside glass door;
- .....
- Heat-resistant plates for the heater/stove.
- .....

## TECHNICAL SPECIFICATION

People	6-8 persons
Timber	Spruce / Thermowood
Shape	Round
Room	2
2.18 m length sauna room volume	8 m <sup>3</sup>
2.69 m length sauna room volume	10 m <sup>3</sup>
Total height	2400 mm
Floor thickness	18 mm
Wall thickness	38 mm
External dimension	2238 x 4000 mm
Door size	690 x 1800 mm
Interior tinted glass door	685 x 1850 mm
Window size	213 x 665 mm

## OPTIONS

### ROOF COLOR

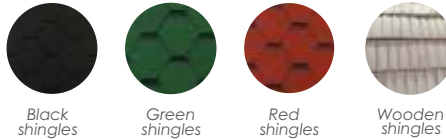

### AVAILABLE THICKNESS OF THE SIDE BOARDS

- .....
- 38 mm boards from spruce (standard)
- .....
- 58 mm boards from spruce (available)
- .....
- 38 mm boards from thermowood (available)
- .....

### AVAILABLE WINDOWS

- .....
- 2 rectangular windows in back wall (standard)
- .....
- 2 windows in front wall
- .....
- 2 in front and 2 in back wall
- .....
- Without front windows, with big windows in back
- .....
- 2 in front and big windows in back
- .....
- Full glass back wall, without windows in front
- .....
- Full glass back wall and 2 windows in front
- .....
- Half glass back wall without windows in front
- .....
- Half glass back wall with 2 windows in front
- .....

### AVAILABLE FRONT DOOR

- .....
- Wooden door with tempered glass window (standard)
- .....
- Wooden door with large window
- .....
- Tempered glass door
- .....

### OTHER OPTIONS

- .....
- Exterior painting.
- .....
- Led lighting (for assembled product).
- .....

### TRANSPORTATION AND ASSEMBLY

- .....
- Not assembled, KIT (L x W x H):** 4.10 x 1.20 x 1.30 m.
- Assembled (L x W x H):** 4.10 x 2.32 x 2.40 m.
- Weight:** 1200 kg; **Assembly:** 2 people in 8 hours.
- .....
- Sauna Barrel with the eco-friendly roof is delivered only fully assembled.
- .....

## INSIDE PLAN

### AVAILABLE LAYOUT

1. With 0.6 m terrace at the front, 1 m length changing room, 2.18 m length sauna room (8 m<sup>3</sup>)
- .....
2. Without terrace, 1 m length changing room, 2.68 m length sauna room (10 m<sup>3</sup>)
- .....
3. Without terrace, 1.49 m length changing room, 2.19 m length sauna room (8 m<sup>3</sup>)
- .....

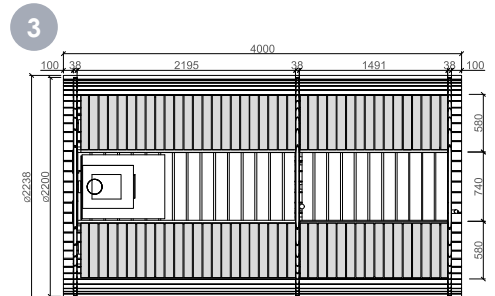
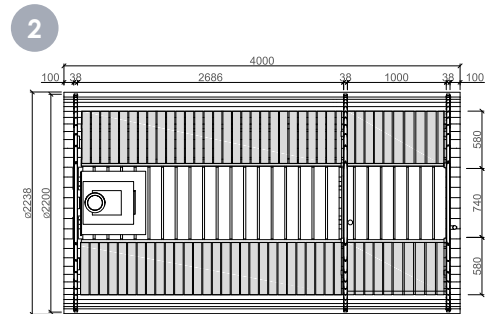
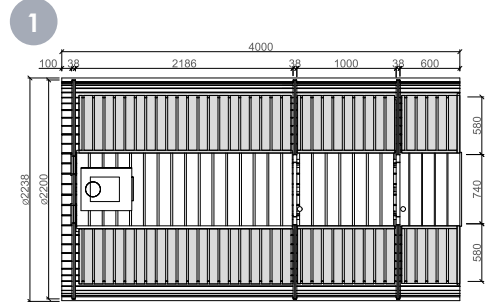



**BESPOKE**  
Sauna Barrel (thermo wood) Ø2.2 x 4 m with eco friendly roof  
Location: Lake Zürich, Switzerland.





ORIGINAL SHAPE



Vertical sauna is delivered almost fully assembled, only a roof needs to be attached

If you're looking for something a little more unique in appearance, then this type of model is probably right up for you.

Original, two-level seating and a high-quality vertical sauna! This type of model has better air circulation than other saunas and is ideal for very small gardens or backyards.

## STANDARD SET

- .....
- Oval shape sauna;
- .....
- Roof covered with bitumen shingles of your selected color;
- .....
- Stainless steel tightening bands;
- .....
- 6 tempered glass windows (not opening);
- .....
- Door with a lock and a tempered glass window;
- .....
- Sauna benches;
- .....
- Heat-resistant plates for the heater/stove.
- .....

## TECHNICAL SPECIFICATION

.....	.....
People	5-7 persons
.....	.....
Timber	Spruce
.....	.....
Shape	Oval
.....	.....
Room	1
.....	.....
Inside area	7.7 m <sup>2</sup>
.....	.....
Sauna room area / volume	4.5 m <sup>2</sup> / 9 m <sup>3</sup>
.....	.....
Total height	3041 mm
.....	.....
Floor thickness	18 mm
.....	.....
Wall thickness	38 mm
.....	.....
External dimension	2059x 2450 mm
.....	.....
Door size	690 x 1800 mm
.....	.....
Window size	200 x 200 mm
.....	525 x 200 mm
.....	850 x 200 mm
.....	.....

## OPTIONS

**ROOF COLOR**



Black shingles



Green shingles



Red shingles

**TRANSPORTATION AND ASSEMBLY**

Vertical Sauna is delivered to the customer fully assembled, only a roof needs to be attached.

**Size of cargo (L x W x H):** 2.60 x 2.40 x 2.55 m and 2 x 1.20 x 2 m.

**Weight:** 1100 kg.

**Assembly:** 2 people can assemble Sauna in 3 hours.

Ideal for small garden or backyard



## INSIDE PLAN

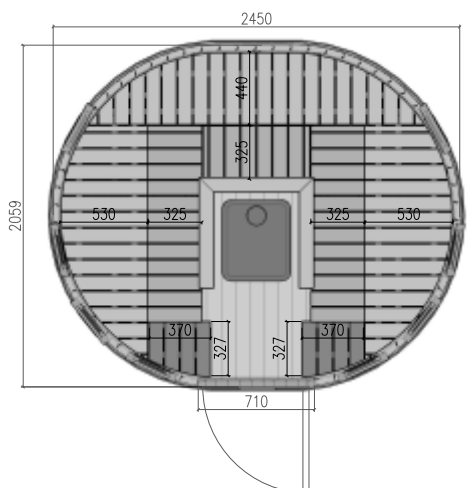

# OTHER SIZES OF SAUNA BARRELS

These are several sizes of one or comfortable two rooms Sauna Barrels from spruce or thermowood.

PRODUCT	AVAILABLE LAYOUTS	STANDARD SET
Sauna Barrel Ø1.9 X 2.5 m SPRUCE / THERMOWOOD	<ol style="list-style-type: none"> <li>1. With 0.60 m terrace at the front, 1.72 m length sauna room (5 m<sup>3</sup>)</li> <li>2. Without terrace, only 2.22 m length sauna room (7 m<sup>3</sup>)</li> </ol>	<p>Sauna Barrel from spruce or thermowood; Roof covered with bitumen shingles of your selected color; Stainless steel tightening bands; 2 tempered glass windows in the back wall (brown); Door with a lock and a tempered glass window; Sauna benches; Heat-resistant plates for the heater/stove.</p>
Sauna Barrel Ø1.9 X 3 m SPRUCE / THERMOWOOD	<ol style="list-style-type: none"> <li>1. With 0.60 m terrace at the front, 2.22 m length sauna room (7 m<sup>3</sup>)</li> <li>2. Without terrace, only 2.72 m length sauna room (8 m<sup>3</sup>)</li> </ol>	<p>Sauna Barrel from spruce or thermowood; Roof covered with bitumen shingles of your selected color; Stainless steel tightening bands; 2 tempered glass windows in the back wall (brown); Door with a lock and a tempered glass window; Sauna benches; Heat-resistant plates for the heater/stove.</p>
Sauna Barrel Ø2.2 X 2 m SPRUCE WOOD	Without terrace at the front, 1.72 m length sauna room (6 m <sup>3</sup> )	<p>Sauna Barrel; Roof covered with bitumen shingles of your selected color; Stainless steel tightening bands; 2 tempered glass windows in the back wall (brown); Door with a lock and a tempered glass window; Sauna benches; Heat-resistant plates for the heater/stove.</p>
Sauna Barrel Ø2.2 X 2.5 m SPRUCE WOOD	<ol style="list-style-type: none"> <li>1. With 0.6 m terrace at the front, 1.72 m length sauna room (7 m<sup>3</sup>)</li> <li>2. Without terrace, only 2.22 m length sauna room (8 m<sup>3</sup>)</li> </ol>	<p>Sauna Barrel; Roof covered with bitumen shingles of your selected color; Stainless steel tightening bands; 2 tempered glass windows in the back wall (brown); Door with a lock and a tempered glass window; Sauna benches; Heat-resistant plates for the heater/stove.</p>
Sauna Barrel Ø2.2 X 3 m SPRUCE / THERMOWOOD	<ol style="list-style-type: none"> <li>1. With 0.6 m terrace at the front, 2.22 m length sauna room (8 m<sup>3</sup>)</li> <li>2. Without terrace, only 2.72 m length sauna room (10 m<sup>3</sup>)</li> </ol>	<p>Sauna Barrel; Roof covered with bitumen shingles of your selected color; Stainless steel tightening bands; 2 tempered glass windows in the back wall (brown); Door with a lock and a tempered glass window; Sauna benches; Heat-resistant plates for the heater/stove.</p>



# SAUNA BARREL

## AVAILABLE WINDOWS IN BACK WALL

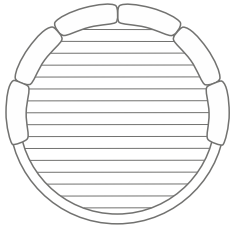

### FULL BACK WALL

Full wooden back wall. Available for all Sauna Barrels.

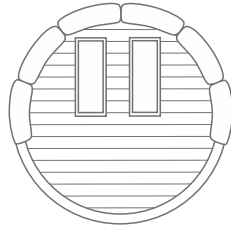

### 2 WINDOWS IN BACK WALL

For all Sauna Barrels, standard 2 windows in back wall. Window size is 213 x 665 mm.

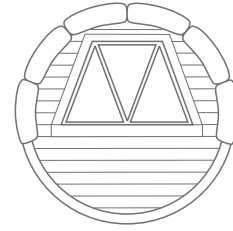

### DECORATIVE WINDOW IN BACK WALL

For  $\varnothing 1.9$  m Sauna Barrels, custom big window.

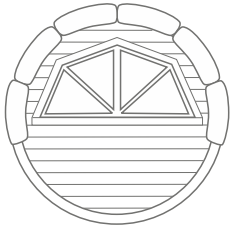

### DECORATIVE WINDOW IN BACK WALL

Only for  $\varnothing 2.2$  m Sauna Barrels, custom big window.

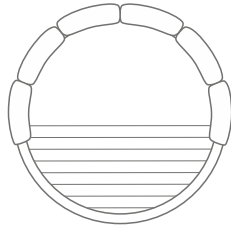

### HALF GLASS BACK WALL

Half glass back wall available for  $\varnothing 1.9$  m and  $\varnothing 2.2$  m Sauna Barrels.

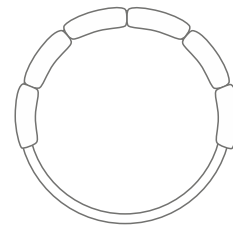

### FULL GLASS BACK WALL

Full glass back wall available for  $\varnothing 1.9$  m and  $\varnothing 2.2$  m Sauna Barrels.

Glass is 10 mm thick, tempered, brown-toned and covered with a 100 micron protective film.

## AVAILABLE DOORS AND WINDOWS IN FRONT WALL

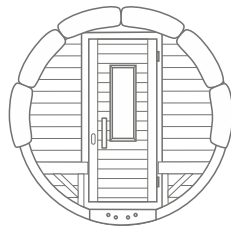

### STANDARD DOOR

Standard wooden front door with window (690 x 1800 mm).

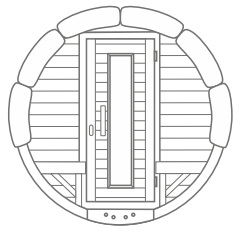

### STANDARD DOOR WITH LARGE WINDOW

Custom wooden front door with large glass window (690 x 1800 mm).

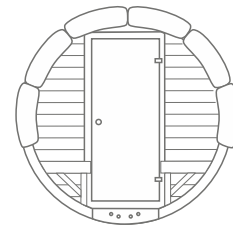

### TEMPERED GLASS FRONT DOOR

Custom tempered glass front door.

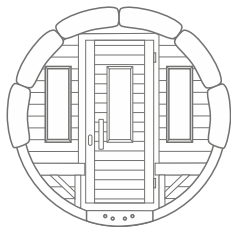

### 2 EXTRA WINDOWS IN FRONT WALL

For all sauna barrels, 2 extra windows in front wall. Windows size are 213 x 665 mm.

## AVAILABLE LAYOUT PLAN

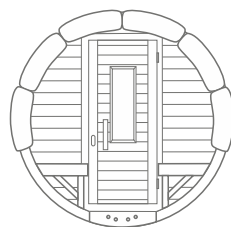

### MINI TERRACE IN FRONT

**0.6 m length terrace** + sauna room. Available for all Sauna Barrels, except for 2 m length Sauna Barrel.

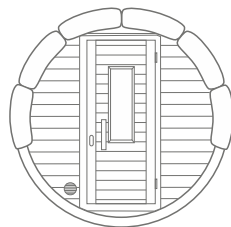

### WITHOUT TERRACE

Available for all Sauna Barrels.

# SAUNAS

## ROOF SHINGLES

Bitumen tiles consist of durable and highly resistant fiberglass bases coated with a polymer-reinforced bitumen mix made of high-quality bitumen and aggregate.

The top layer of tiles is surfaced with mineral granules that lend color to the tiles and ensure high UV- protection and other weather conditions resistance qualities. The granules are painted at high temperatures using the thermal method of pigment being burned into the surface of granules which guarantees long durability of the color.

The bottom of the tiles is coated with an adhesive polymer-reinforced bitumen layer protected with an easily removed silicon membrane. As a result of sun heat exposure, the overlapped tiles stick to each other thus forming a double hydro-insulating layer, which guarantees excellent leak resistance of the roof.

You may choose black, green, or red color bitumen tiles.

The products correspond to the requirements of harmonized EU standard EN 544.

## USAGE

### PREPARING YOUR SAUNA FOR USE

- If you have a wood-burning heater, make sure to remove the protective film of the heater chimney before heating.
- Ensure that the Sauna door is unlocked and easy to open before using it.
- Do not mount any additional accessories or shelves above the heater.
- Turn the Sauna heater on.
- The thermometer should be located at head level in the Sauna.
- Wait for the Sauna to reach the required temperature (**normally 80 - 90° C**).

All users should be aware of the potential dangers and requirements prior to participation in the Sauna!

### THINGS TO NOTE WHEN USING THE SAUNA

Enjoy the many health benefits of the relaxing heat of your Sauna. But remember: being inside the hot Sauna for long periods of time raises your body temperature, which may be dangerous, especially for those with a heart condition or other health risks. Generally, the recommended time inside a Sauna is **from 10 to 15 minutes**. After a period of heating, take a five-minute break and then repeat.

- Be very careful when moving in the Sauna, as the benches and floors may be slippery!
- The Sauna should not be used by pregnant women or very young children.
- Remove all jewelry before entering the hot Sauna.

## MAINTENANCE

Wood is a natural material and can change through time. Cracks of various sizes and structural or color changes are not defects – rather, they are features of the wood. Natural wood (not impregnated) becomes grayish after being left untouched for a while. Later it can turn blue and get covered with mold.

- Impregnate and paint the wood to protect the product from the outside. We recommend inspecting Sauna every 6 months and evaluating the need of re-impregnation, and re-painting.
- When not in use, keep a bucket full of water in the Sauna during summer.
- The doors of the Sauna must be adjusted regularly.
- You should keep the sauna ventilation open all the time, to allow it time to dry and air out to avoid mold.
- To remove bench stains, use mild soapy water and a soft cotton cloth. This can also be used on the heater itself - just make sure it's off and completely cool when you clean it.
- Don't use harsh or abrasive chemicals on benches, as these can bleach and warp the wood, ruining the grain and turning it grey.

## AVAILABLE WOOD AND THICKNESS



**Thermo wood**  
44 mm thickness boards

**Spruce wood**  
38 mm thickness boards

**Spruce wood**  
58 mm thickness boards

Barrel sauna can be made of FSC-certified spruce wood or thermo wood. The thickness of the sauna barrel wall is 38 mm or 58 mm. The thickness of solid wood flooring is 18 mm.

The thermal modification process uses high heat in a controlled atmosphere to improve the durability (significantly longer wood life) of the wood as well as to increase its dimensional stability: reduces swelling and shrinkage, as well as breaking and checking. Dissolution of Moisture: The process of sealing the structure of the cellular tree makes it waterproof and moisture-proof. Solid brown color to the center of the board itself.

In order to avoid branchiness and resin flow, we produce the benches sauna only from deciduous wood. Benches of deciduous wood are in all saunas, regardless of whether they are made from spruce or from thermo wood.



Where traditions meet innovation.  
Where the space you own meets the product we have.  
Where the real people meet the unreal experience.

# LUXURY SAUNAS

# DELIGHT SAUNA 2.4 X 4.3 m



MODERN PRODUCT



Unique design, different diameter sauna!



Our new model of sauna with half glass window in front and LED lightening!

Different diameter sauna for more sitting and standing comfort! The new model makes for a space-saving, yet comfortable, sauna experience for the users. While great consideration was given to budget and function, equal consideration was given to unique form as this sauna is beautifully finished inside and out with several upgrade features like a new sauna room backrest model a and new design of sitting room benches.

## STANDARD SET

- "Delight sauna" is made from spruce wood;
- Roof covered with bitumen shingles of your selected color;
- Stainless steel tightening bands;
- The half glass window in the front wall;
- Door with a lock and a big tempered glass window;
- "Storage benches" in the sitting room has a hinged top which can be opened;
- 2 sauna benches from deciduous wood;
- 3 pcs of ventilation;
- Backrest in sauna room;
- Heat-resistant plates for the heater/stove.

## TECHNICAL SPECIFICATION

People	6-8 persons
Timber	Spruce
Shape	Oval
Room	2
Inside area	4.6 m <sup>2</sup>
Sauna room area / volume	2.2 m <sup>2</sup> / 9.6 m <sup>3</sup>
Total height	2500 mm
Floor thickness	18 mm
Wall thickness	38 mm
External dimension	2440 x 4290 mm
Door size	700 x 1800 mm
Interior tinted glass door	700 x 1860 mm
Window size (in front)	0.95 x 1.90 mm
Sitting room benches	2.07 x 0.42 x 0.52 mm 1.46 x 0.46 x 0.52 mm
Sauna benches (alder wood)	2.07 x 0.50 x 0.52 mm 1.17 x 0.54 x 0.52 mm

### AVAILABLE WINDOWS

Round Ø100 cm window, not opening

## OPTIONS

### ROOF COLOR

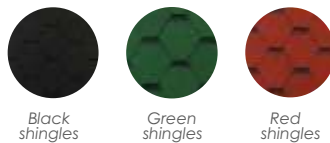

### AVAILABLE THICKNESS OF THE SIDE BOARDS

- 38 mm boards from spruce (standard)
- 58 mm boards from spruce (available)
- 38 mm boards from thermowood (available)

### AVAILABLE LIGHTENING FOR SAUNA

- Front wall: between wall and panoramic window
- On the sides of the front door
- Sauna room: both sides under the sauna benches
- Sitting room: in the ceiling

### TRANSPORTATION AND ASSEMBLY

- Size of assembled cargo (L x W x H): 4.30 x 2.40 x 2.50 m.
- Size of pallet (L x W x H): 4.30 x 1.20 x 2.55 m.
- Weight: 1200 kg.

## INSIDE PLAN

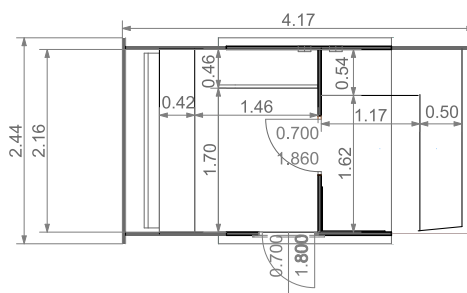

## CUT VIEW

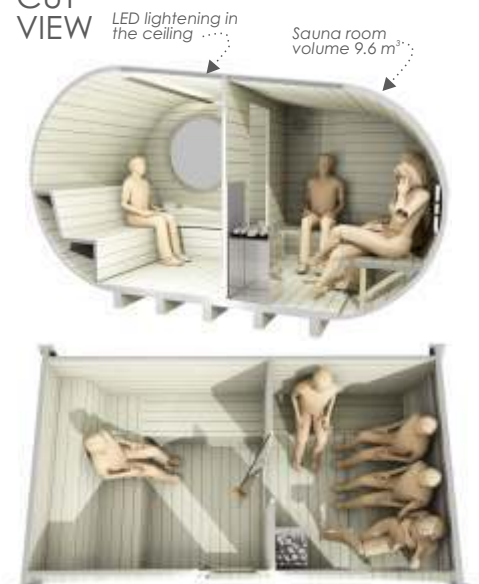



"Delight Sauna" 2.4 x 4.3 m



Sitting room with "storage benches"

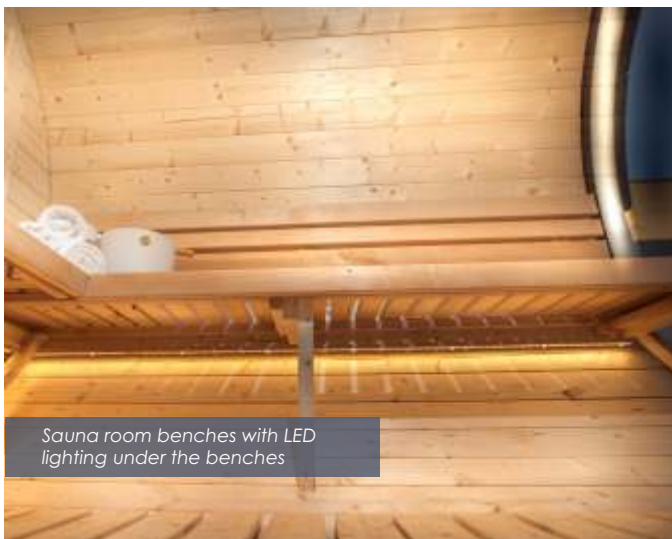

Sauna room benches with LED lighting under the benches



Sitting room with LED lighting and accessories (as an option)

# SAUNA BARREL Ø2.2 X 3 m

LUXURY

Full glass window in the back wall

Modern looking backrests



WITH LED LIGHTS

This sauna model goes fully assembled, painted and with LED lighting!

The sauna is equipped with led lights. LEDs strips are used on the outside of the sauna, 2 meters on the sides of the sauna, under the roof edge, and on the sides of the front door. 8 meters of LEDs are used inside of the sauna: on both sides of the sauna under the benches and under the back supports (2 meters on each side).

## STANDARD SET

- Sauna Barrel from thermo wood;
- Roof covered with bitumen shingles of your selected color;
- 3 (without terrace) and 4 (with terrace) stainless steel tightening bands;
- The full glass window in the back wall;
- 2 opening windows in the front wall;
- Door with a lock and a rectangle tempered glass window;
- Modern looking and solid backrests from deciduous wood;
- 2 sauna benches from deciduous wood;
- Heat-resistant plates for the heater/stove;
- Ventilation;
- 7 m of led strips are used on the outside of the sauna and 8 m inside sauna;
- This sauna goes to the customer fully assembled, painted in white and black, in a complete set.

## TECHNICAL SPECIFICATION

People	7-8 persons
Timber	Thermowood
Shape	Round
Room	1
2.22 m sauna room volume	9 m <sup>3</sup>
2.72 m sauna room volume	11 m <sup>3</sup>
Total height	2400 mm
Floor thickness	18 mm
Wall thickness	38 mm
External dimension	2237 x 3000 mm
Door size	690 x 1800 mm
Window size	213 x 665 mm

## OPTIONS

### ROOF COLOR

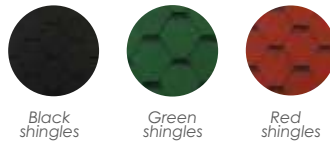

Black shingles

Green shingles

Red shingles

### AVAILABLE FRONT DOOR

- Wooden door with tempered glass window (standard)
- Wooden door with large rectangular tempered glass window
- Tempered glass door

### TRANSPORTATION AND ASSEMBLY

Assembled (L x W x H): 3.10 x 2.32 x 2.40 m.  
Weight: 1000 kg.

\*Sauna barrel with the glass back wall is delivered only fully assembled.

Electric heater Harvia Cilindro (as extra)



## INSIDE PLAN

### AVAILABLE LAYOUT

- With 0.6 m terrace at the front, 2.22 m length sauna room (9 m<sup>3</sup>)
- Without terrace, only 2.72 m length sauna room (11 m<sup>3</sup>)

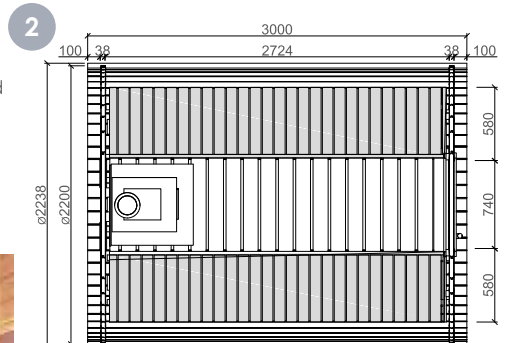
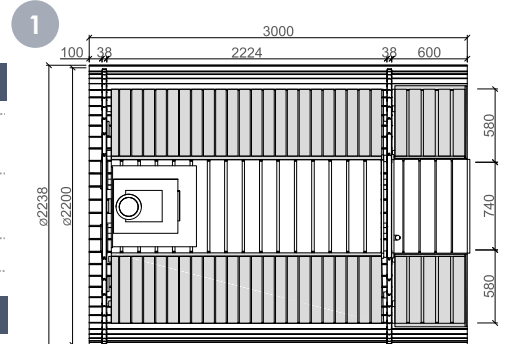

## VIKING TIP!

### USE "VASTA"

A "vasta" or "vihta" (the name depends on the region) is a bundle of fresh birch twigs that you gently whip yourself with. It sounds strange, but is really good for your skin - you'll feel the smoothness afterwards.



# SAUNA LUNA 2.3 X 2.4 m

LUXURY



Sauna room volume 10 m<sup>3</sup>

Large window (1711x768 mm) in the back wall (as extra)



Luna goes with inside LED lighting! (as extra)

Meet the Luna, our new outdoor Sauna model that looks as good on the inside as it does on the outside. From its smooth curves to its large windows, it's built with a mix of comfort and modernity. The gently rounded corners have added appeal and give you lots of space for the Sauna. Door and windows with tempered tinted glass and eye-catching finishing details complete the high-quality impression, which continues confidently in the interior.

## STANDARD SET

- Marine plywood frame construction;
- Walls and roof made from spruce wood;
- Two windows at the front wall;
- Door with a lock and a big tempered glass window;
- Premium quality door fittings;
- Adjustable ventilation;
- Two sauna room benches and backrests inside.

## TECHNICAL SPECIFICATION

People	4-6 persons
Timber	Spruce
Shape	Rectangle
Room	1
Sauna room volume	10 m <sup>3</sup>
Total height	2370 mm
Exterior cladding	18 mm
Interior cladding	12 mm
External dimension	2347 x 2240 mm
Door size	740 x 1725 mm
Window size	180 x 880 mm

### TRANSPORTATION

Not assembled, KIT (L x W x H): 2.40 x 1.20 x 2.48 m.  
Assembled (L x W x H): 2.44 x 2.35 x 2.40 m.

## OPTIONS

### AVAILABLE WINDOWS

- 2 windows in front wall (standard)
- 2 windows in back wall
- 2 in front and 2 in back wall
- Without front windows, with big window in back
- 2 in front and big window in back
- Full glass back wall, without windows in front
- Full glass back wall and 2 windows in front

### OTHER OPTIONS

- Sauna room interior from deciduous wood
- Inside LED lighting
- Insulated walls, roof
- Exterior painting

## INSIDE PLAN

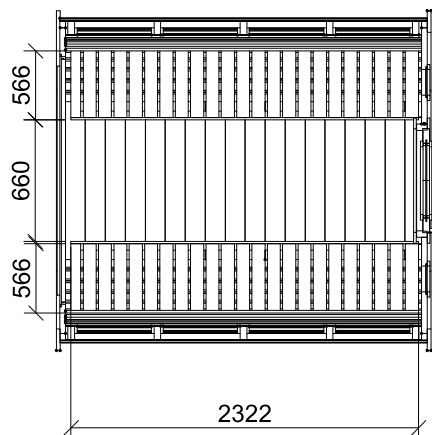

Luna with full glass back wall



# SAUNA LUNA 3.3 X 2.4 m

LUXURY



Sauna room volume 8 m<sup>3</sup>

The large sauna room window invites sunshine into the room and lets you look out into the breathtaking views.



Back wall without windows as a standard

NEW DESIGN

Say yes to relaxing in your own backyard!

An outdoor sauna that comes in a minimalist and modern design combination. LUNA really redefines the concept of home wellness. You are making it all about relaxing in true elegance, with a minimalist and contemporary design.

This outdoor sauna model also comes with a changing room. You can easily use it to store your stuff or maybe you need quickly to change before stepping into the sauna.

## STANDARD SET

- Marine plywood frame construction;
- Walls and roof made from spruce wood;
- 2 rooms inside: sauna and changing room;
- Front wall with large sauna room window;
- Back wall without windows;
- Door with a lock and a big tempered glass window;
- Tempered glass sauna room door;
- Premium quality door fittings;
- Two sauna room benches and backrests inside;
- Adjustable ventilation.

## TECHNICAL SPECIFICATION

People	6-8 persons
Timber	Spruce
Shape	Rectangle
Room	2
Sauna room volume	8 m <sup>3</sup>
Total height	2356 mm
Exterior cladding	18 mm
Interior cladding	12 mm
External dimension	3300 x 2241 mm
Door size	740 x 1725 mm
Window size	1442 x 1948 mm

## OPTIONS

### OPTIONS

- Sauna room interior from deciduous wood
- Big window in a back wall
- Inside LED lighting
- Insulated walls, roof
- Changing room bench

## DRAWINGS

Cut view

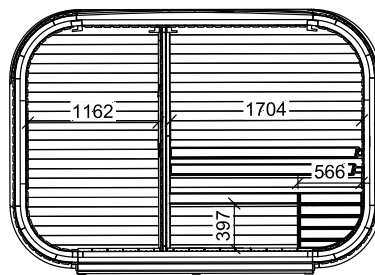

### TRANSPORTATION

Not assembled, KIT (L x W x H): 3.30 x 1.20 x 2.48 m.

Assembled (L x W x H): 3.30 x 2.44 x 2.37 m.

Weight: 1360 kg.



We say that being different is beautiful.  
So is our Sauna Pod!

# SAUNA PODS

# SAUNA POD 2.4 X 2.3 m



Low sauna benches for legs

Sauna Pod 2.4 x 2.3 m is a beautiful solution for gardens with "soft edges". It looks nice and is different from the popular sauna cabins or sauna barrels. It can also be built next to the Camping Pod and make your camping place look smooth and cozy.

Handcrafted with spruce wood this quality kit will give you years of sauna enjoyment!

## STANDARD SET

- ..... Sauna pod made from spruce;
- ..... Roof covered with bitumen shingles of your selected color;
- ..... One room inside: a sauna room;
- ..... 2 tempered glass windows in the back wall;
- ..... Tempered glass door with wooden handle;
- ..... Benches for sitting and 2 low sauna benches for legs of deciduous wood in sauna room;
- ..... Heat-resistant plates for heater/stove.

## OPTIONS

**ROOF COLOR**



Black shingles



Green shingles



Red shingles

**TRANSPORTATION AND ASSEMBLY**

**Size of pallet (L x W x H):** 2.30 x 1.20 x 2.55 m.

**Size of assembled cargo:** 2.30 x 2.45 x 2.60 m.

**Weight:** 1400 kg.

**Assembly:** 2 people can assemble Sauna in 8 hours.

## TECHNICAL SPECIFICATION

People	2-3 persons
Timber	Spruce / Thermowood
Shape	Pod
Room	1
Inside area	4.7 m <sup>2</sup>
Sauna room area / volume	4.7 m <sup>2</sup> / 8.8 m <sup>3</sup>
Total height	2585 mm
Floor thickness	28 mm
Wall thickness	38 mm
External dimension	2454 x 2390 mm
Door size	685 x 1854 mm
Window size	209 x 654 mm
Sauna benches	595 x 2024 mm

## DRAWINGS

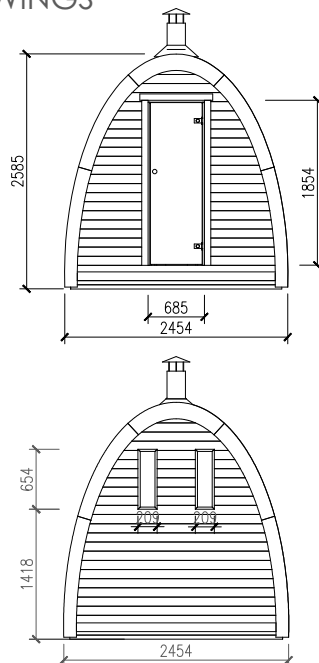

## INSIDE PLAN

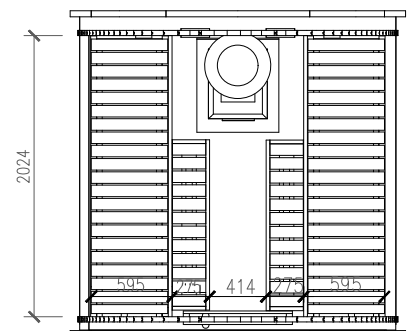

**BACK WALL OPTION**

..... Pod with full glass back wall

# SAUNA POD 2.4 X 4 m



Sauna Pod is made from spruce wood. Upon the customer's request, we can install a wood-fired furnace or an electric heater in the sauna. The thickness of the Sauna pod walls is 38 mm; thickness of the solid wood flooring is 28 mm. A roof is covered with bitumen shingles of selected color: black, red, or green. The sauna pod is 4 m long and 2.4 m wide. The overall height including the roof is 2.58 m.

## STANDARD SET

- .....
- Sauna pod made from spruce;
- .....
- Roof covered with bitumen shingles of your selected color;
- .....
- Two rooms inside: a sauna room and a changing room;
- .....
- 2 tempered glass windows in the back wall;
- .....
- Double doors with a lock and the double glass windows;
- .....
- Inside glass door between a sauna and a changing room;
- .....
- Benches for sitting and 2 low sauna benches for legs of deciduous wood in sauna room;
- .....
- Heat-resistant plates for heater/stove.
- .....

## TECHNICAL SPECIFICATION

People	2-4 persons
Timber	Spruce / Thermowood
Shape	Pod
Room	2
Inside area	9.6 m <sup>2</sup>
Sauna room area / volume	5.3 m <sup>2</sup> / 9.3 m <sup>3</sup>
Total height	2585 mm
Floor thickness	28 mm
Wall thickness	38 mm
External dimension	2400 x 4000 mm
Door size	1020 x 1900 mm
Interior tinted glass door	698 x 1855 mm
Window size	220 x 660 mm
Sitting room benches	500 x 1500 mm
Sauna benches	600 x 2224 mm

## OPTIONS

**ROOF COLOR**



Black shingles



Green shingles



Red shingles

**BACK WALL OPTION**

Pod with full glass back wall

**TRANSPORTATION AND ASSEMBLY**

- .....
- Size of pallet (L x W x H):** 4 x 1.20 x 2.60 m.
- Size of assembled cargo:** 4 x 2.40 x 2.60 m.
- Weight:** 1700 kg.
- Assembly:** 2 people assemble Sauna in **10 hours**.

## INSIDE PLAN

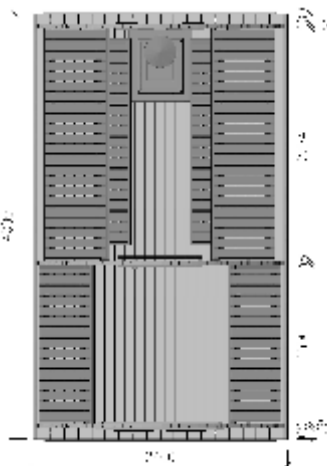

Sauna benches  
600 x 2224 mm (W x L)  
from deciduous wood

# SAUNA POD

2.4 x 2.4  
2.4 x 3  
2.4 x 4

## HALF

Can be customized front, back and side walls

Can choose different pod sides: left or right

Three different sizes

MODULAR DESIGN



Can be connected with other half pod

Inspired by you produced by Viking!

In today's market, leisure products come in many shapes and sizes. We aim to provide our customers with a product to suit their needs today, or simply ready for use in the backyard, office, or campsite. With Half Pod's modular design, you can create a completely customized product to suit your needs and budget!

## STANDARD SET

Half pod made from spruce wood;

Roof covered with bitumen shingles of your selected color;

Left or Right side alignment;

Pod front, back and side walls customization;

Heat-resistant plates for heater/stove.

## TECHNICAL SPECIFICATION

People	2-4 persons
Timber	Spruce
Shape	Pod
Room	1-2
Total height	2585 mm
Floor thickness	28 mm
Wall thickness	38 mm

With this modular design available to connect two totally customized pods



## OPTIONS

### ROOF COLOR



Black shingles



Green shingles



Red shingles

### MORE OPTIONS

Different layouts: with or without terrace; one or two rooms inside

Different Half pod sides: left, right

Front/back/side walls modifications: without door and windows; glass door; 2 tempered glass windows for Sauna room

Two pods connection: 2 customized Half Pods connected through the side wall

Exterior painting

### TRANSPORTATION AND ASSEMBLY

**2.4 x 2.4 m Pod size of pallet (L x W x H):**

2.50 x 1.20 x 1.25 m.

**2.4 x 3 m Pod size of pallet (L x W x H):**

3.10 x 1.20 x 1.25 m.

**2.4 x 4 m Pod size of pallet (L x W x H):**

4.10 x 1.20 x 1.25 m.

**2.4 x 2.4 m size of assembled cargo:**

2.50 x 2.40 x 2.60 m.

**2.4 x 3 m size of assembled cargo:**

3.10 x 2.40 x 2.60 m.

**2.4 x 4 m size of assembled cargo:**

4.10 x 2.40 x 2.60 m.



Available three different layouts:

1. Sauna room without terrace;
2. Sauna room with terrace
3. Sauna room with changing room and without terrace



# HALF SAUNA POD

## FRONT / BACK / SIDE WALL

### AVAILABLE DOOR IN FRONT/BACK WALL

Tempered, brown-toned glass door (690 x 1890 mm)

TEMPERED GLASS DOOR

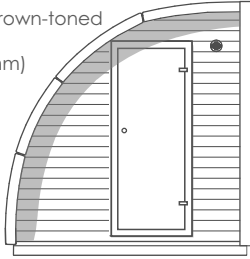

### AVAILABLE WINDOWS IN FRONT/BACK WALL

2 pcs of opening and brown-toned windows, suitable for Pods with sauna room

One window size is 750 x 350 mm

TEMPERED GLASS WINDOWS FOR SAUNA ROOM 750 x 350 mm

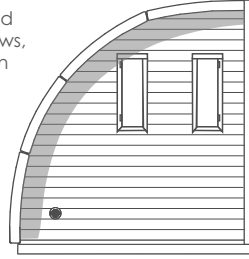

### AVAILABLE EMPTY FRONT/BACK WALL

Side wall modifications available only for Single Pod versions!

WITHOUT DOOR AND WINDOWS

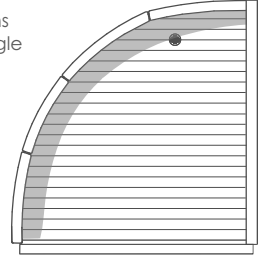

LEFT POD

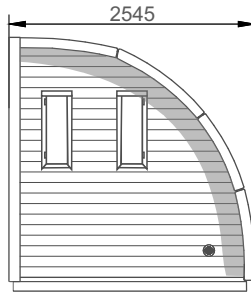
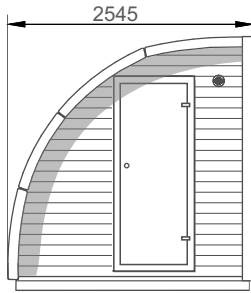

RIGHT POD

### SIDE WALL AVAILABLE WITH DOOR, WINDOWS OR EMPTY

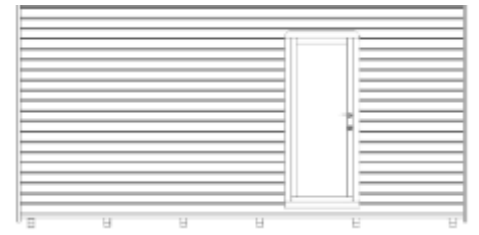

## HALF POD - MODULAR DESIGN

### IDEAS FOR YOUR NEXT PROJECT

Connected two Half Pods:

Left Side Pod, 2.4 x 4 m size Half Pod with sauna and changing room

Right Side Pod 2.4 x 4 m size Half Pod with terrace.

Connected two Half Pods:

Left Side Pod, 2.4 x 4 m size Half Pod with sauna room

Right Side Pod 2.4 x 4 m size Half Pod with terrace.



And here is an interior idea of what you can create with two empty Half Pods . . . . .



With this modular design available to connect two totally customized pods



# SAUNA CUBES

Modern appearance to fit in modern garden.  
With an *old-school* heat benefit.



# SAUNA CUBE<sup>2x2</sup>



Insulated full panel wall. Wall frame 75 x 45 mm, panel covered with inside 96 x 12 mm and outside 145 x 18 mm horizontal spruce cladding boards

990 x 2195 mm (W x H) wooden door with large tempered glass windows

Sauna benches from deciduous wood

Wall frame (75 x 45 mm) with full tempered glass window



## FRAME

The frames are made from glue-laminated spruce beams. The frame consists of a bottom frame (100 x 140 mm), columns (140 x 140 mm), top frame (140 x 200 mm) and withstands 295 kg/m<sup>2</sup> roof load.

## STANDARD SET

- ..... Sauna cube frame from spruce;
- ..... Wooden floor;
- ..... Roof panels with self-adhesive bitumen membrane;
- ..... 2 wooden tempered glass walls;
- ..... 5 insulated full panel walls;
- ..... 2 insulated roof panels;
- ..... Sauna benches from deciduous wood;
- ..... Heat-resistant plates for the heater/stove;
- ..... Wooden door with tempered glass window.

### TRANSPORTATION AND ASSEMBLY

Sauna cube 2 x 2 is delivered to the customer not assembled, but with detailed assembly instructions and drawings, and packed on a pallet (KIT).  
**Size of the cargo (L x W x H), not assembled product on pallet ready for transportation:**

2.60 x 1.20 x 2.55 m.

Two or three people can assemble sauna cube 2 x 2 m in 6 hours.

## TECHNICAL SPECIFICATION

Shape	4 corners
External dimension (W x L)	2286 x 2286 mm
Inside area / sauna room volume	2853 mm / 17 m <sup>3</sup>
Total high (H)	4 m <sup>2</sup> / 17 m <sup>3</sup>
Number of sauna benches	2
Size of door (W x H)	990 x 2170 mm
Group of people	2-4 persons
Weight	1300 kg
Size of pallet (L x W x H)	2600 x 1200 x 2550 mm Not assembled
Wood	Spruce

## INSIDE PLAN

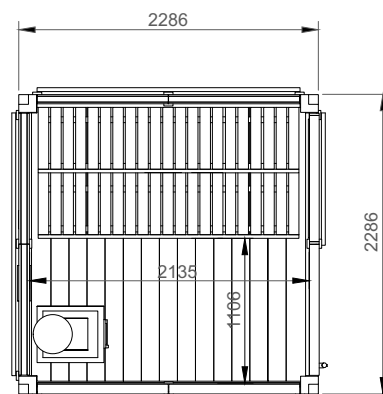

Sauna room volume is 17 m<sup>3</sup>



# SAUNA CUBE<sup>2x3</sup>

## WITH/WITHOUT CHANGING ROOM



Sauna room volume is 24 m<sup>3</sup>



WITH CHANGING ROOM

Sauna room volume is 17 m<sup>3</sup>

### STANDARD SET (WITHOUT CHANGING ROOM)

- ..... Garden cube frame from spruce;
- ..... Wooden floor;
- ..... Roof panels with self-adhesive bitumen membrane;
- ..... 3 wooden tempered glass walls;
- ..... 6 insulated full panel walls;
- ..... Insulated roof panels;
- ..... Sauna benches from deciduous wood;
- ..... Heat-resistant plates for the heater/stove;
- ..... Wooden door with windows.

### TECHNICAL SPECIFICATION

..... Shape	..... 4 corners
..... External dimension (W x L)	..... 2286 x 3286 mm
..... Total high (H)	..... 2853 mm
..... Inside area	..... 4 m <sup>2</sup> / 6 m <sup>2</sup>
..... Number of sauna benches	..... 2
..... Size of door (W x H)	..... 990 x 2170 mm
..... Group of people	..... 2-5 persons
..... Weight	..... 1680 kg
..... Wood	..... Spruce

#### TRANSPORTATION AND ASSEMBLY

Sauna cube 2 x 3 is delivered to the customer not assembled, but with detailed assembly instructions and drawings, and packed on a pallet (KIT).

**Size of the cargo (L x W x H), not assembled product on pallet ready for transportation:**

3.40x1.20x2.60 m

### STANDARD SET (WITH CHANGING ROOM)

- ..... Garden cube frame from spruce;
- ..... Wooden floor;
- ..... Roof panels with self-adhesive bitumen membrane;
- ..... 2 wooden tempered glass walls;
- ..... 7 insulated full panel walls;
- ..... 1 decorative sunscreen wall with tempered glass;
- ..... Insulated roof panels;
- ..... Sauna benches from deciduous wood;
- ..... Heat-resistant plates for the heater/stove;
- ..... Wooden door with windows;
- ..... Inside glass door;
- ..... Two spaces inside: a sauna and a changing room.

### INSIDE PLAN

Without changing room



With changing room



Bespoke Sauna Cube project in Czech Republic

# SAUNA CUBE 2x4



WITH CHANGING ROOM

Sauna room volume is 24 m<sup>3</sup>



Possible modifications. An example of a unique project

## FRAME

The frames are made from glue-laminated spruce beams. Frame consists of bottom frame (100 x 140 mm), columns (140 x 140 mm), top frame (140 x 200 mm) and withstands 295 kg/m<sup>2</sup> roof load.

## STANDARD SET

- ..... Garden cube frame from spruce;
- ..... Wooden floor;
- ..... Insulated roof panels;
- ..... 1 decorative sunscreen wall with tempered glass;
- ..... 3 wooden tempered glass walls;
- ..... 7 insulated full panel walls;
- ..... 2 insulated roof panels;
- ..... Sauna benches from deciduous wood;
- ..... Two spaces inside: a sauna and a changing room;
- ..... Heat-resistant plates for the heater;
- ..... Inside tempered glass door;
- ..... Wooden door with windows.

## TECHNICAL SPECIFICATION

Shape	4 corners
External dimension (W x L)	2286 x 4286 mm
Total high (H)	2853 mm
Inside area	8 m <sup>2</sup>
Sauna area / sauna room volume	6 m <sup>2</sup> / 24 m <sup>3</sup>
Number of sauna benches	2
Size of door (W x H)	990 x 2170 mm
Group of people	2-5 persons
Size of pallet (L x W x H)	4400 x 1200 x 2550 mm Not assembled
Wood	Spruce

## INSIDE PLAN

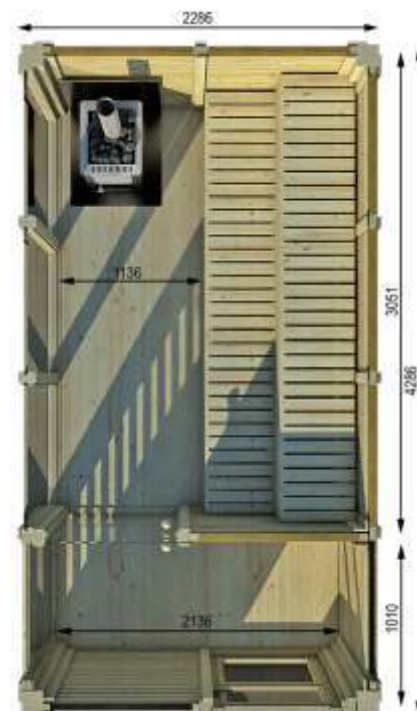

## TRANSPORTATION AND ASSEMBLY

Sauna Cube 2 x 4 with changing room is delivered to the customer not assembled, but with detailed assembly instructions and drawings, and packed on a pallet (KIT).

**Size of the cargo (L x W x H), not assembled product on pallet ready for transportation:**  
4.40 x 1.20 x 2.55 m

Two or three people can assemble sauna cube 2 x 4 m with changing room in 8 hours.

# SAUNA CUBE 3x3



The frames are made from glue-laminated spruce beams. Frame consists of bottom frame (100 x 140 mm), columns (140 x 140 mm), top frame (140 x 200 mm) and withstands 183 kg/m<sup>2</sup> roof load.

## INSIDE VIEW



## ROOF

The roof panels are built with double rafters construction and covered with 18 x 145 mm finishing boards. This construction withstands 295 kg/m<sup>2</sup>. All cube buildings' roofs are 2.9 m high and 1.310 (2.29%) slope. We use MIDA SELF KSK for roof covering, its self-

adhesive elastomeric bitumen membrane covering the entire surface. Installation of the rolled roofing is a quick, simple, and safe way to cover all Cube. All you must do is unroll, attach with nails, remove the protective film, and press.

Sauna room volume is 17 m<sup>3</sup>

## STANDARD SET

- ..... Garden cube frame from spruce;
- ..... Roof panels with self-adhesive bitumen membrane;
- ..... 6 standard full panel walls;
- ..... 7 insulated full panel walls;
- ..... 1 insulated full panel wall with rectangle window;
- ..... Insulated roof panels;
- ..... Sauna benches from deciduous wood;
- ..... Four spaces inside:
  1. A sauna room 2 x 2 m (4 m<sup>2</sup>).
  2. Lobby 1 x 2 m.
  3. Wardrobe 1 x 1 m.
  4. A shower room 1 x 2 m.
- ..... Heat-resistant plates for the heater/stove;
- ..... Inside glass doors for sauna;
- ..... Wardrobe room door;
- ..... Shower room door;
- ..... Wooden door with tempered glass windows;

## TECHNICAL SPECIFICATION

Shape	4 corners
External dimension (W x L)	3286 x 3286 mm
Total high (H)	2853 mm
Inside area	9 m <sup>2</sup>
Sauna area / sauna room volume	4 m <sup>2</sup> / 17 m <sup>3</sup>
Number of sauna benches	2
Wooden door	990 x 2170 mm
Size of shower door (W x H)	852 x 1890 mm
Size of sauna glass door (W x H)	685 x 1850 mm
Group of people	6 persons
Wood	Spruce

## INSIDE PLAN

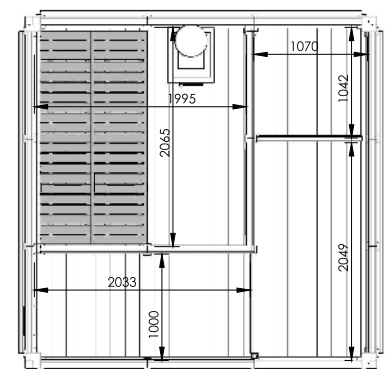

### AVAILABLE THE RAINWATER PIPES

The rainwater pipe package includes a straight gutter and all parts needed for installation. The downpipe package includes a 2.5 m downpipe and all parts needed for installation. No need for exact measurements and calculations and easy to transport and install, as all components needed are packaged compactly in a single package, ensuring safe delivery and easy installation. The rainwater pipes are made from plastic. The rainwater pipes' color is antracite.

### TRANSPORTATION AND ASSEMBLY

Sauna Cube 3 x 3 is delivered to the customer not assembled, but with detailed assembly instructions and drawings, and packed on a pallet (KIT).

**Size of the cargo (L x W x H), not assembled product on pallet ready for transportation:**  
3.40 x 1.20 x 2.55 m

Two or three people can assemble Sauna Cube 3x3 m in 10 hours.

# SAUNA CUBE 3x4



WITH CHANGING/SHOWER ROOM

The frames are made from glue-laminated spruce beams. Frame consists of bottom frame (100 x 140 mm), columns (140 x 140 mm), top frame (140 x 200 mm) and withstands 183 kg/m<sup>2</sup> roof load.

## INSIDE



Sauna room volume is 17 m<sup>3</sup>

## ROOF

The roof panels are built with double rafters construction and covered with 18 x 145 mm finishing boards. This construction withstands 295 kg/m<sup>2</sup>. All cube buildings' roofs are 2.9 m high and 1.310 (2.29%) slope. We use MIDA SELF KSK for roof covering, its self-

adhesive elastomeric bitumen membrane covering the entire surface. Installation of the rolled roofing is a quick, simple, and safe way to cover all Cube. All you must do is unroll, attach with nails, remove the protective film, and press.

## STANDARD SET

- ..... Garden cube frame from spruce;
- ..... Wooden floor;
- ..... Roof panels with self-adhesive bitumen membrane;
- ..... 4 standard full panel walls;
- ..... 3 decorative sunscreen walls with tempered glass;
- ..... 2 wooden tempered glass walls;
- ..... 4 insulated full panel walls;
- ..... 2 insulated full panel walls with small windows;
- ..... 2 insulated roof panels;
- ..... Sauna benches from deciduous wood;
- ..... Three spaces: sauna, lounge and a shower room;
- ..... Heat-resistant plates for the heater/stove;
- ..... Aluminium sliding doors system Alutech;
- ..... Inside glass doors;
- ..... Changing room door/partition.

## TECHNICAL SPECIFICATION

Shape	4 corners
External dimension (W x L)	3286 x 4286 mm
Total high (H)	2853 mm
Inside area	12 m <sup>2</sup>
Sauna area / sauna room volume	4 m <sup>2</sup> / 17 m <sup>3</sup>
Number of sauna benches	3
Size of sliding door (W x H)	2000 x 2200 mm
Western saloon door (W x H)	852 x 1890 mm
Size of glass door (W x H)	685 x 1850 mm
Group of people	6 persons
Weight	1620 kg
Wood	Spruce



### AVAILABLE THE RAINWATER PIPES

The rainwater pipe package includes a straight gutter and all parts needed for installation. The downpipe package includes a 2.5 m downpipe and all parts needed for installation. No need for exact measurements and calculations and easy to transport and install, as all components needed are packaged compactly in a single package, ensuring safe delivery and easy installation. The rainwater pipes are made from plastic. The rainwater pipes' color is brown.

### TRANSPORTATION AND ASSEMBLY

Sauna Cube 3 x 4 is delivered to the customer not assembled, but with detailed assembly instructions and drawings, and packed on a pallet (KIT).

**Size of the cargo (L x W x H), not assembled product on pallet ready for transportation:**  
4.40 x 1.20 x 2.55 m

Two or three people can assemble Sauna Cube 3 x 4 m in 10 hours.



Inside lounge room with table and benches set + white cushion set



# SAUNA CUBE 3x5



## FRAME

The frames are made from glue-laminated spruce beams. Frame consists of bottom frame (100 x 140 mm), columns (140 x 140 mm), top frame (140 x 200 mm) and withstands 183 kg/m<sup>2</sup> roof load.



Sauna room volume is 17 m<sup>3</sup>

## SAUNA ROOM

Inside sauna: 2 sauna benches 500 x 2065 mm (W x L) is made from deciduous wood; Sauna room volume is 17 m<sup>3</sup>. The Aluminum sliding doors system (3 rails) is 3000 x 2200 mm. Western saloon door-partition for shower room (from spruce) - 852 x 1890 mm; Glass door for sauna room - 685 x 1850 mm.

## STANDARD SET

- ..... 2 units garden cube frames from spruce 3 x 3 m + 3 x 2 m;
- ..... Roof panels with self-adhesive bitumen membrane;
- ..... 9 standard full panel walls;
- ..... 7 insulated full panel walls;
- ..... Insulated roof panels;
- ..... Sauna benches from deciduous wood;
- ..... Three spaces inside:
  1. A sauna room 2 x 2 m (4 m<sup>2</sup>).
  2. Lounge room 3 x 3 m (9 m<sup>2</sup>).
  3. A shower room 1 x 2 m.
- ..... Heat-resistant plates for the heater/stove;
- ..... Inside glass door for sauna;
- ..... Shower room door;
- ..... Aluminium sliding doors system (3 rails) Alutech.

## TECHNICAL SPECIFICATION

..... Shape	..... 4 corners
..... External dimension (W x L)	..... 3286 x 5572 mm
..... Total high (H)	..... 2853 mm
..... Inside area	..... 15 m <sup>2</sup>
..... Sauna area / sauna room volume	..... 4 m <sup>2</sup> / 17 m <sup>3</sup>
..... Number of sauna benches	..... 2
..... Size of sliding door (W x H)	..... 3000 x 2200 mm
..... Size of shower door (W x H)	..... 852 x 1890 mm
..... Size of glass door (W x H)	..... 685 x 1850 mm
..... Group of people	..... 6 persons
..... Wood	..... Spruce

## INSIDE PLAN



### AVAILABLE THE RAINWATER PIPES

The rainwater pipe package includes straight gutter and all parts needed for installation. Downpipe package includes 2.5 m downpipe and all parts needed for installation. No need for exact measurements and calculations and easy to transport and install, as all components needed are packaged compactly in a single package, ensuring safe delivery and easy installation. The rainwater pipe is made from plastic. The rainwater pipes' color is brown.

### TRANSPORTATION AND ASSEMBLY

Sauna Cube 3 x 5 m is delivered to the customer not assembled, but with detailed assembly instructions and drawings, and packed on a pallet (KIT). Size of the cargo (L x W x H), not assembled product on pallet ready for transportation:  
**1st pallet** - 3.40 x 1.20 x 2.55 m;  
**2nd pallet** - 3.40 x 1.20 x 2.55 m.  
 Two or three people can assemble Sauna Cube 3 x 5 m in 10 hours.



Bespoke project in Czech Republic

# SAUNA CUBE 3x6



WITH CHANGING ROOM

## FRAME

The frames are made from glue-laminated spruce beams. Frame consists of bottom frame (100 x 140 mm), columns (140 x 140 mm), top frame (140 x 200 mm) and withstands 183 kg/m<sup>2</sup> roof load.

## ROOF

The roof panels are built with double rafters construction and covered with 18 x 145 mm finishing boards. This construction withstands 295 kg/m<sup>2</sup>. All cube buildings' roofs are 2.9 m high and 1.310 (2.29%) slope.

We use MIDA SELF KSK for roof covering, its self-

adhesive elastomeric bitumen membrane covering the entire surface. Installation of the rolled roofing is a quick, simple, and safe way to cover all Cube. All you must do is unroll, attach with nails, remove the protective film, and press.

## STANDARD SET

2 units garden cube frames from spruce 3 x 4 m + 3 x 2 m;

Roof panels with self-adhesive bitumen membrane;

17 standard full panel walls;

7 standard insulated full panel walls;

Insulated roof panels;

Sauna benches from deciduous wood;

Four spaces inside:

1. A sauna room 2 x 2 m (4 m<sup>2</sup>).

2. Lounge room 3 x 3 m (9 m<sup>2</sup>).

3. A shower room 1 x 2 m.

4. Changing room 1 x 2 m.

Heat-resistant plates for the heater/stove;

Inside glass doors for sauna;

Wooden shower room door;

Wooden changing room door;

Aluminium sliding doors system (3 rails) Alutech.

## TECHNICAL SPECIFICATION

Shape	4 corners
External dimension (W x L)	3286 x 6572 mm
Total high (H)	2853 mm
Inside area	18 m <sup>2</sup>
Sauna area / sauna room volume	4 m <sup>2</sup> / 17 m <sup>3</sup>
Number of sauna benches	2
Size of sliding door (W x H)	3000 x 2200 mm
Size of shower door (W x H)	852 x 1890 mm
Size of glass door (W x H)	685 x 1850 mm
Group of people	6 persons
Wood	Spruce

Sauna room volume is 17 m<sup>3</sup>



## INSIDE PLAN



### AVAILABLE THE RAINWATER PIPES

The rainwater pipe package includes a straight gutter and all parts needed for installation. The downpipe package includes a 2.5 m downpipe and all parts needed for installation. No need for exact measurements and calculations and easy to transport and install, as all components needed are packaged compactly in a single package, ensuring safe delivery and easy installation. The rainwater pipes are made from plastic. The rainwater pipes' color is brown.

### TRANSPORTATION AND ASSEMBLY

Sauna Cube 3 x 6 with changing room is delivered to the customer not assembled, but with detailed assembly instructions and drawings, and packed on a pallet (KIT).

**Size of the cargo (L x W x H), not assembled product on pallet ready for transportation:**

**1st pallet** - 4.40 x 1.20 x 2.55 m;

**2nd pallet** - 3.40 x 1.20 x 2.55 m.

Two or three people can assemble sauna cube 3 x 6 m with changing room in 11 hours.

## FOR VIKING SAUNA CUBES



### RAINWATER PIPES

Available for all cubes

The rainwater pipe package includes straight gutter and all parts needed for installation. Downpipe package includes 2.5 m downpipe and all parts needed for installation. No need for exact measurements and calculations and easy to transport and install, as all components needed are packaged compactly in a single package, ensuring safe delivery and easy installation. The rainwater pipe is made from plastic. The rainwater pipes' color is antracite.



### CEILING LAMP

Available for all Sauna Cube with changing room and all Viking Cubes

Standard set: wooden pendant light to light up your cube. Size: 1500 x 600 mm. Made from spruce. *Important: these lamps are not available in the sauna room.*



### TABLE AND BENCHES SET

Available for Sauna Cube with changing room and all Viking Cubes

Modern design table and benches set contains: table on wheels (450 x 600 mm); bench (450 x 1400); bench with a backrest (800 x 1900 mm). Made from spruce.

### WHITE CUSHION SET

White imitation leather cushion set designed to fit table and benches set.



### WOODEN BUCKET FOR WATER

With plastic inside, 4 liters

Our wooden buckets are of high-quality. The plastic inner part prolongs the life of the product and makes the cleaning easy.



### WOODEN LADLE

Together with the wooden buckets, the wooden ladles form a traditional package for your sauna. The wooden ladle is great for sprinkling water on the stones to create sauna steam.



### THE BUCKET + LADLE DUO

Color: white or black

The bucket+ladle are inseparable and that is why they come in the same package. Bucket height - 20 cm; Bucket diameter - 24 cm; Bucket weight - 652 g; Bucket volume - 5,0l; Ladle overall length - 41 cm; Ladle weight - 183 g; Ladle volume - 0,3 l. Package dimensions - 21 x 25 x 25 cm.



### WOODEN HEADREST

The elegantly designed headrest is a beautiful touch for your sauna. As well it is a comfortable accessory.



### SAUNA LIGHT COVER

Beautiful wooden sauna light cover. The sauna lamp and wooden lampshade compose a basic sauna light fitting that is easy to assemble. The classic design of the lamp and lampshades makes it suitable for any sauna.



### SAUNA LIGHT "HARVIA"

Protection level IP44. Bulb E14 (max. 40 W) is not included in the delivery.

# ACCESSORIES

## FOR SAUNA CUBES



**THERMOMETER-HYDROMETER  
„HARVIA“**

Thermometer - hydrometer helps you to keep an eye on both the sauna temperature and air humidity.



**22 LITERS WATER TANK FOR  
WOOD BURNING HEATERS**

The water tank (22l) is mounted directly above the heater. The water heats up quickly because the pipe going through the tank functions as a wall of the water tank.



**CLOTHES HANGER**

An excellent solution for hanging towels in the changing room. It is made from durable wood and is wall-mounted.



**BACKREST**

Backrest helps to sit more comfortably in the sauna. Alder or aspen wood.



**SAFETY FENCE FOR  
ELECTRIC HEATERS**

A safety fence is made from spruce wood. It protects and allows to keep proper safety distances from the hot electric heater.



**SAFETY FENCE FOR  
WOOD BURNING HEATERS**

A safety fence is made from spruce wood. It protects and allows you to keep proper safety distances from hot wood-burning heaters.

## HEATERS AND CHIMNEY KIT

### ELECTRIC HEATERS



**HARVIA TRENDI KIP90,  
9 kW (8-14 M<sup>3</sup>)**

A reliable basic heater. The KIP is a traditional wall-mounted heater with either a built-in control panel or a separate control unit. The large stone space provides optimal heat release. The outer casing temperature of the heater stays low. The recommended size of the sauna room is 8-14 m<sup>3</sup>. Safety distance to the wall - 120 mm, safety distance to floor - 150 mm. Heater dimension (W x H x D) is: 410 x 600 x 280 mm.



**HARVIA CLUB, 13.5 kW (11-20 M<sup>3</sup>)  
HARVIA CLUB, 15 kW (11-20 M<sup>3</sup>)**

Superheater for heavy-duty use. The Club heaters from Harvia are designed to serve as true super heaters capable of providing heat for large numbers of users from morning till night. Heaters used in large saunas or continuously must be functional, efficient and comfortable to use. The floor-mounted Club electric heaters are of the world-famous Harvia quality. They are completely made of stainless steel and provide the power and durability required for heavy-duty use. The Club heaters are excellent for health clubs, wellness centres, hotels, holiday resorts, indoor swimming pools, large family saunas and other facilities where saunas are in frequent use. The Club heaters are controlled by a separate control unit. Safety distance to wall - 100 mm. Heater dimension (W x H x D) is: 505 x 700 x 430 mm.



**HARVIA LEGEND PO11 / PO165,  
11 kW (9-20 M<sup>3</sup>); 16.5 kW (16-35 M<sup>3</sup>)**

The Harvia Legend product family is a story about authenticity and extremely durable Harvia quality. Every Harvia Legend product is part of the heroic story of Harvia, founded in 1950 and currently the world's largest sauna heater and stove manufacturer. Every Legend heater and stove is a handmade masterpiece by Harvia's master blacksmiths. The patinated steel frame of Legend contains a large amount of stones, resulting in wonderfully humid and gentle clouds of steam reminiscent of those of a wood-heated sauna.

## HEATERS AND CHIMNEY KIT

### ELECTRIC HEATERS



**HARVIA CILINDRO PC90XE,  
9 kW (8-14 M<sup>3</sup>)**

Harvia Cilindro heater is stylish electric heater ideal for many needs. The size and massive stone quantity of the heater are optimized to provide a smooth, yet powerful sauna bath in saunas of all sizes – from small family saunas to large. Harvia model XE heaters feature an integrated control unit and are controlled via the Xenio control panel.

Features: Heater temperature adjustment, On-time control, Lighting adjustment, Parental control, Door sensor, Remote control option (requires the adoption of the Harvia mobile switch-on function and a separate safety device).



**HARVIA ELEGANCE,  
16.5 kW (16-30 M<sup>3</sup>)**

This heater is suited for installing in the middle of the floor or embedding into the bench, for example. Made of stainless steel, this quality heater is best suited for public saunas and large family saunas. Width - 50 cm. Depth of 50 cm. Height 70 cm. Stones included. Stones capacity: 60 kg. Weight without stones: 26 kg.

Harvia Elegance is an elegant heater that catches the eye. The Elegance heater is controlled by a separate control unit.



Harvia Cilindro PC90XE, 9 Kw (8-14 m<sup>3</sup>)

# ACCESSORIES

## HEATERS AND CHIMNEY KIT

### WOODBURNING HEATERS



**HARVIA M3,  
16.5 kW (6-13 M<sup>3</sup>)**

A stylish stove for smaller saunas. The Harvia M3 has a classic design and is suitable for smaller, woodburning saunas. The recommended size of the sauna room is 6–13 m<sup>3</sup>. The stones and a standard chimney KIT is included.



**HARVIA M3 SL,  
16.5 kW (6-13 M<sup>3</sup>)**

A stylish stove for smaller saunas. The SL model is designed for people who want to conveniently heat their sauna from outside. The stones and a standard chimney KIT is included.



**HARVIA PRO20,  
24.1 kW (8-20 M<sup>3</sup>)**

For vigorous bathing. Harvia 20 Pro gives a good hot bath in medium-sized saunas. It has a big stone space and an air-flow spoiler made of stainless steel. Through the cast-iron glass door, the warm glow of the fire adds to the sauna atmosphere. The sturdy 10 mm fire space cover ensures durability. This model also features adjustable legs to facilitate installation and, for example, help in adjusting the height of the smoke outlet, and it can be equipped with a pipe mounted water heater. The outer casing of the stove is painted graphite black. The recommended size of the sauna room is 8–20 m<sup>3</sup> and the maximum amount of stones is 40 kg.



**HARVIA SL20 (OUTSIDE FIREWOOD FEEDING), 24.1 kW (8-20 M<sup>3</sup>)**

Ease of use reaches a new level. The SL models are designed for people who want to conveniently heat their sauna from another room or outside the building. The opening direction of the door can be changed, making these stoves even easier to use. SL heaters provide great bathing in small and medium-sized saunas.

While one bather is still sitting in the sauna, the other one can cook sausages over the fire or watch the fire glowing behind the cast-iron-framed glass door.



**HARVIA 26 PRO,  
26.6 kW (10-26 M<sup>3</sup>)**

The Harvia 26 Pro stove is designed for vigorous bathing in medium-sized saunas. The fire glowing behind the cast-iron-framed glass door adds to the atmosphere of the sauna. Heater dimensions: width - 43 cm; depth - 51 cm; height - 81 cm. Stones and standard chimney KIT included.



**HARVIA 36, 31 kW (14-36 M<sup>3</sup>)**

The Harvia 36 stove is a powerhouse stove for large saunas. The generous amount of stones guarantees a proper sauna experience for a large group of people. Heater dimensions: width - 51 cm; depth - 51 cm; height - 81 cm. Stones and standard chimney KIT included.

Water tubs have a great effect on your physical and emotional health. They also do not take much space in your garden or yard, but provide great leisure opportunities. Water tubs perfectly complement the range of campsite services. Also for all kinds of hot tubs we offer options and accessories like SPA system, LED lights, covers, scoop and poker, wooden paddle and wooden bottle holder.

# HOT TUBS



# HOT TUBS WOODEN

Ø 1.5 m   Ø 1.9 m   Ø 2.2 m

Spruce wood Hot Tub with inside heater and chimney safety fence



THREE DIFFERENT SIZES

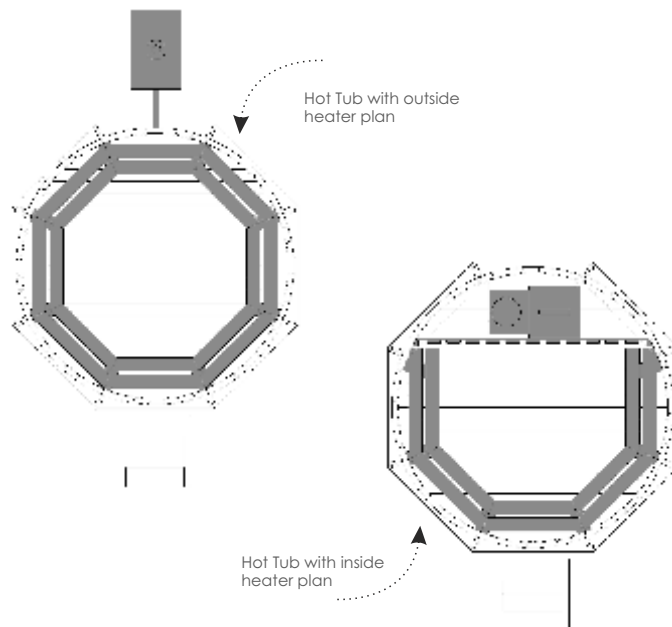

Our wooden Hot Tubs can be made out of from spruce or thermo wood. Standard Hot Tub's depth is 95 cm, floor's and side walls' thickness is 38 mm. All screws used for the Hot Tub are made from stainless steel.

The inside heater and benches are fixed to the walls. This makes it easy to clean the Hot Tub after use. Models with external (outside) wood-burning heaters can fit in more people.

The Hot Tubs have a water discharge valve, which is ready for the hose connection, so water can be drained whenever you want.

## STANDARD SET

- ..... Hot tub made from spruce or thermo wood;
- ..... Stainless steel tightening bands;
- ..... Stainless steel heater with a chimney (inside or outside the hot tub);
- ..... Wooden inside benches;
- ..... Safety fence for the hot tubs with the heaters inside;
- ..... Outlet valve;
- ..... Stairs „3 steps“.

## AVAILABLE DIAMETERS

**1.5 m hot tub** – for 4 persons or for 6 persons if a hot tub has an external heater.

**1.9 m hot tub** – for 6 persons or for 8 persons if a hot tub has an external heater.

**2.2 m hot tub** – for 8 persons or for 10 persons if a hot tub has an external heater.

## OPTIONS

- ..... Sand filter 4 m<sup>3</sup>/h
- ..... Thickness of the side boards: 38 mm (standard); 58 mm
- ..... Impregnation with color



Thermo wood Hot Tub with inside heater

Spruce wood Hot Tub with outside heater

## IMPORTANT!

Before using the Hot Tub, remember:  
Water will leak at first, but within 3-5 days the wooden tub will swell and become completely watertight.



Product	Available heater	Capacity, l	Weight	Product package	Assembling time	Timber
Ø 1.5 m Hot Tub	- Inside standard - External standard round - External 8-corners	1600 l	190 kg	Assembled cargo (L x W x H): 1.7 x 1.2 x 1.9 m KIT (L x W x H): 2 x 1.2 x 0.6 m		Spruce/ Thermo wood
Ø 1.9 m Hot Tub	- Inside standard - External standard round - External 8-corners	2250 l	315 kg	Assembled cargo (L x W x H): 2.1 x 1.2 x 2.2 m KIT (L x W x H): 2 x 1.2 x 0.6 m	One person can easily assemble our Hot Tub in 1.5-2.5 hours depending on the size of it	Spruce/ Thermo wood
Ø 2.2 m Hot Tub	- Inside standard - External standard round - External 8-corners	3420 l	350 kg	Assembled cargo (L x W x H): 2.4 x 1.2 x 2.5 m KIT (L x W x H): 2.2 x 1.2 x 0.7 m		Spruce/ Thermo wood
Ø1.9 m Wooden Hot Tub - AL Standard KIT*	- Aluminum (internal) heater with stainless steel chimney	2250 l	315 kg	KIT size (L x W x H): 1.95 x 1.2 x 0.7 m		Spruce

1.9 m wooden hot tub - AL standard KIT without armrests

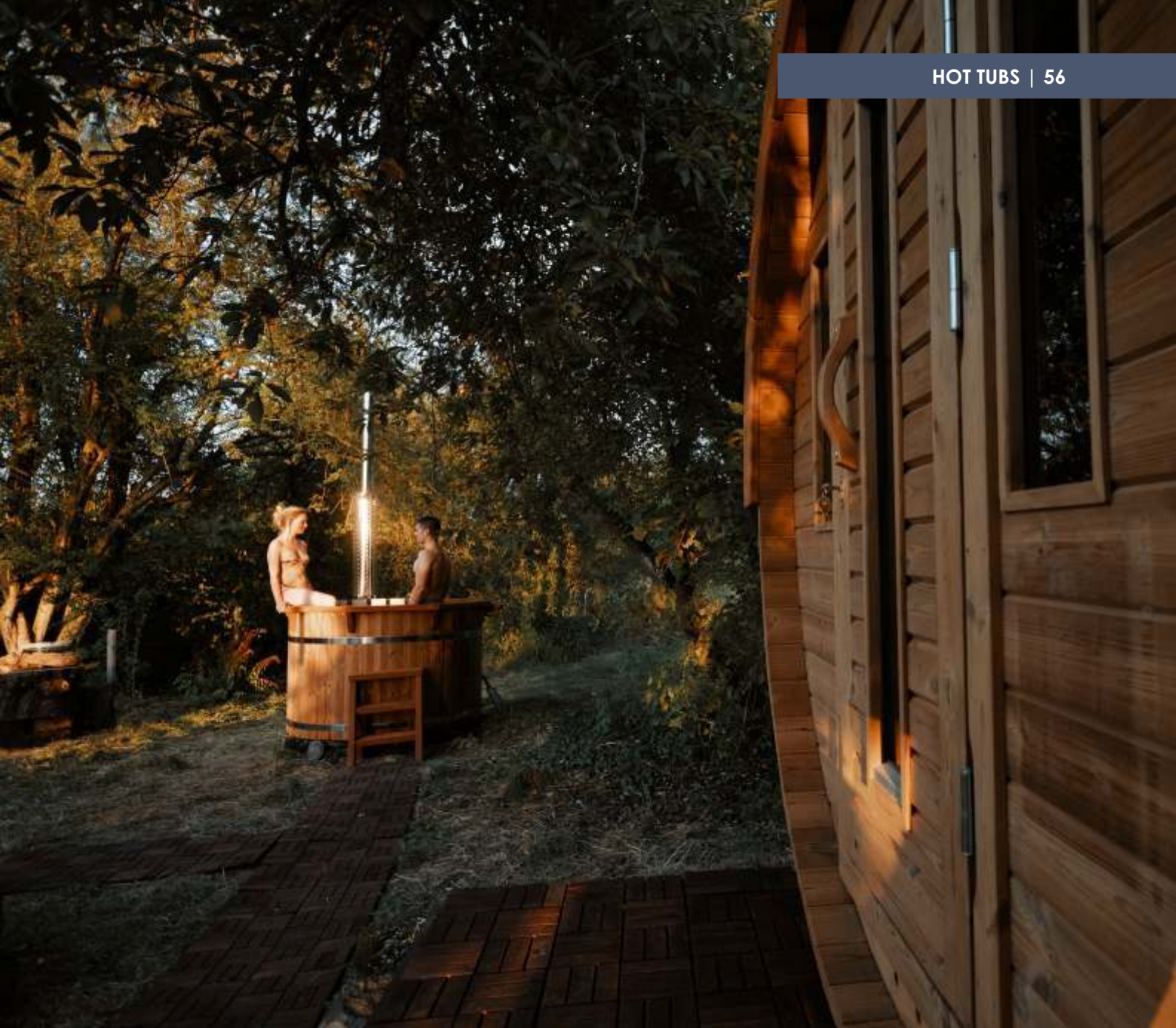

# COLD TUBS

Oval Round

## WOODEN



### STANDARD SET

- Spruce wood Cold Tub;
- Stainless steel tightening bands;
- Wooden benches inside;
- Outlet valve;
- Stairs.

Product	Size	Wall thickness	Capacity, l	Weight	Product package
<b>Oval Cold Tub</b> Ø 1.5 x 0.85 m	1-2 people	38 mm spruce wood	700 l	115 kg	KIT size (L x W x H): 1.6 x 1.1 x 0.6 m Assembled (L x W x H): 1.6 x 1.1 x 1.3 m
<b>Round Cold Tub</b> Ø 1.2 m					KIT size (L x W x H): 1.4 x 1.1 x 0.6 m Assembled (L x W x H): 1.4 x 1.4 x 1.25

# HOT TUBS

Ø 1.5 m  
Ø 1.9 m  
Ø 2.2 m

## POLYPROPYLENE



Hot Tub with white color of polypropylene insert and external heater

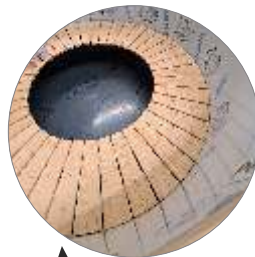

Wooden or polypropylene benches available

WITH POLYPROPYLENE INSERTS

### STANDARD SET

- Wooden hot tub with inside polypropylene frame;
- Stainless steel tightening bands;
- Stainless steel heater with a chimney (inside or outside the hot tub);
- Wooden or polypropylene inside benches;
- Safety fence for the hot tubs with the heaters inside;
- Outlet valve;
- Stairs.

### OPTIONS

- Benches: wooden or polypropylene
- Color of polypropylene insert: white (RAL9010); light grey (RAL7032); black (RAL9005); dark grey (RAL7011); blue (RAL5012)
- Sand filter 4 m<sup>3</sup>/h

Hot Tubs made from the polypropylene sheets are easy to care and are resistant to the temperature changes or a direct sunlight. The exterior of these Hot Tubs is made from the spruce wood, which is more nature friendly, while polypropylene frame inside makes Hot Tub more hygienic.



Available insert colors: white, light grey; black; dark grey; blue



Product	Available heater	Wall thickness	Capacity, l	Weight	Product package
Ø 1.5 m	- Inside standard - External round - External 8-corners	38 mm spruce wood	1600 l	200 kg	Assembled cargo (L x W x H): 1.6 x 1.2 x 1.8 m
Ø 1.9 m			2250 l	220 kg	Assembled cargo (L x W x H): 2 x 1.2 x 2.1 m
Ø 2.2 m			3420 l	250 kg	Assembled cargo (L x W x H): 2.3 x 1.2 x 2.4 m



# HOT TUBS

## FIBERGLASS

### AVAILABLE DIAMETERS

1.8 m hot tub – for 6 persons or for 8 persons if a hot tub has an external heater.

Ofuro hot tub – for 2 persons.

AVAILABLE WITH SPA OPTION

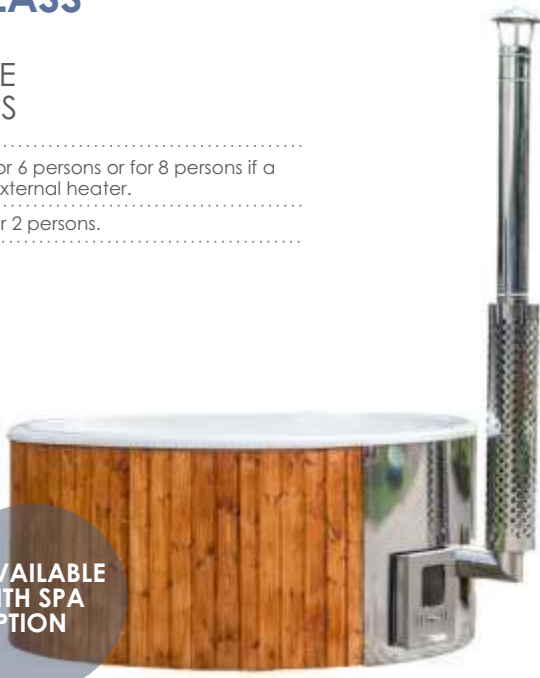

This Fiberglass Tub looks particularly elegant and luxurious, it does not have any additional exterior details that require additional space to be added. If you are the one who does not want to spend a lot of time in the care of the Tub - this and our other Fiberglass Tubs really fit for you. Hot Tubs can be cleaned with plain water or chemicals and will not affect its surface. The glass fiber insert is made of a single piece of fiberglass fabric with curved benches, which allows you to save water and, of course, accelerates the warming of the water in the Tub. The glass fiber liner's surface is smooth, soft, and pleasant to touch. You can choose from four colors you like: gray and cream.

### STANDARD SET

Fiberglass frame hot tub with wooden finishing from the outside;  
 Integrated/outside stainless steel (304) heater with a chimney;  
 Fiberglass inside benches;  
 Outlet valve for water;  
 Stairs from spruce (3 steps).

### OPTIONS

Color of fiberglass: cream (RAL9001); grey (RAL7015);  
 Electric heater Pahlen 3kW; 6 kW  
 Sand filter 4 m<sup>3</sup>/h  
 Thickness of the side boards: 38 mm (standard); 58 mm (as extra)  
 Impregnation with color  
 Wooden transportation box packaging  
 Integrated LED system (3 LED lights)  
 SPA system: air bubble/hydro massage system

Ø 1.8 m Hot Tub with integrated heater

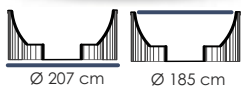

Ø 207 cm

Ø 185 cm

Ø 1.8 m Hot Tub with outside heater

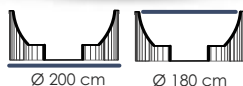

Ø 200 cm

Ø 180 cm

Ofuro Hot Tub

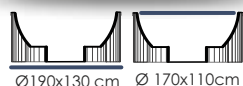

Ø190x130 cm

Ø 170x110cm

Product	Available heater	Capacity, l	Weight	Product package
Ø 1.8 m Hot Tub with integrated heater	- Integrated heater 304 stainless steel - standard / 316 - as extra - Electric heater Pahlen 3 kW/6 kW	1800 l	210 kg	Assembled cargo (L x W x H): 2.10 x 1.20 x 2.30 m
Ø 1.8 m Hot Tub with outside heater	- External round 304 stainless steel - standard / 316 - as extra - External 8 corners 304 stainless steel - standard / 316 - as extra - Electric heater Pahlen 3 kW/6 kW	1600 l	210 kg	Assembled cargo (L x W x H): 2.50 x 1.2 x 2.30 m
Ofuro Hot Tub	- Electric heater Pahlen 3 kW/6 kW	750 l	200 kg	Assembled cargo (L x W x H): 1.90 x 1.20 x 1.16 m



Hot Tub with integrated heater

Hot Tub with outside 8 - corners heater



Hot Tub OFURO with outside 8 - corners heater



## FOR HOT TUBS



### SAFETY FENCE FOR CHIMNEY

Safety fence is made from stainless steel or spruce wood. It allows to keep a proper distance from hot wood burning heaters.



### STAIRS "2 STEPS" OR "3 STEPS"

Wooden stairs made from spruce, 2 steps. Height – 55 cm; width – 55 cm. Wooden stairs made from spruce, 3 steps. Height – 65 cm; width – 50 cm.

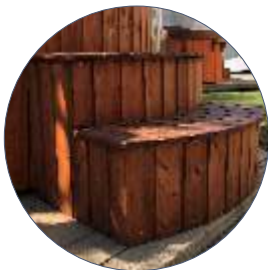

### ROUND STAIRS

Round stairs (2 or 3 steps), made from spruce or thermo wood with niche for sand filter and electric heater.



### WOODEN COVER TENT COVER

**Spruce wood or tent cover for a hot tub** helps to keep the water clean for a longer period of time. 1.5 m diameter cover consists of 2 parts; 1.9 m and 2.2 m diameter cover consists of 3 parts; Round cold tub covers consists of 2 parts; Oval cold tub covers consists of 1 part.



### INSULATED HOT TUB COVER

Insulated cover is made of weather resistant and UV tolerant vinyl. Isolation thickness 75 mm (EPS 150). Half open able. Shorten the heating time up to 2 time; keeps water hot for up to 5 times longer; protects the contents of the tub to the dust and garbage.



### BOTTLE HOLDER

Bottle holder made from spruce for 5 bottles.



### SOLAR THERMOMETER

The Floating Solar Powered Digital Thermometer will let you know what your current water temperature reads. Temperature range: 0 to 50 °C. The battery is used as a backup power source when the sun does not reach the thermometer.



### SCOOP, POKER AND PADDLE

Scoop and poker for the cleaning the hot tub heater. A paddle to stir water.

# ACCESSORIES

## HEATERS

### WOODBURNING HEATERS



**STANDARD INSIDE HEATER, 18 kW  
LARGE INSIDE HEATER, 24 kW**

A standard stainless steel (AISI304/AISI316\*) inside heater 1.5 mm thickness, power 18 kw, which has 5 circulation pipes, two chimney tubes and the roof. This standard heater is suitable for the tubs of 1.5 m and 1.9 m diameters.

A large stainless steel (AISI304) inside heater 1.5 mm thickness, power 24 kw, which has 3 circulation pipes, two chimney tubes and the roof. This large heater is recommended for the 2.2 m diameter hot tubs.



**INTEGRATED HEATER, 30 kW  
(suitable for 1.8 m fiberglass tubs)**

This operating principle is as exterior, but it is installed under the tub, saving space in the yard. It has a glass door as standard and also plays the role of a garden fireplace until the hot tub is heated.

Integrated hot tub heater is wood-fired, therefore no electricity is needed. As well integrated wood burning heaters are more safe compared to submersible hot tub heaters, because they have no risk of touching the hot metal in being the tub.

### ELECTRIC HEATER



**ELECTRIC HEATER PAHLEN 3KW/6KW  
SAND FILTER SATURN 7m<sup>3</sup>/h**

Electric Heater Pahlen 3kW/230V (connection CEE16/230V) and Electric heater Pahlen 6kW/400V (connection CEE16/400V) of fiberglass reinforced thermoplastic - Tough and corrosion-resistant.

**ATTENTION!** We recommend using an electric heater only to keep water warm for a longer period of time, to get the best result to choose heating together with a wood-burning heater!

SAND FILTER SATURN tank is made of polyethylene. The simple construction and perfect technology production ensures work for many years. Recommended replacement of the sand every 1-2 years.



**EXTERNAL ROUND WOOD  
BURNING HEATER, 22 kW**

An outside burning heater. It is a stainless steel (AISI304/AISI316\*) heater 1.5 mm thickness. An external heater will help you to save the space in the tub for at least two persons. The maintenance and use of an external heater is simple; it is easier to stoke and clean it. It is also more convenient to clean a tub if an external heater is selected.



**EXTERNAL 8-CORNERS WOOD  
BURNING HEATER, 20 kW**

The external small hot tub heater 20kw heats efficiently tubs with up to 1.9 m diameter. The furnace is made of 1.5 mm high quality AISI 304/AISI316\* stainless steel, which a chromium content of 16 % gives better corrosion resistance and the grade is used in wide range of heaters.



*\*High quality AISI316 stainless steel, which is most often used in sea water based equipment. It is resistant to sea water and aggressive salinity. This stainless steel has the best corrosion resistant properties.*



REAL PRODUCTS FOR REAL PEOPLE



QUALITY, FLEXIBILITY, SHORT TERMS

[www.vikingindustrier.com](http://www.vikingindustrier.com)

OUR QUALITY STANDARD



Serial No. 2024/02